

Makita®

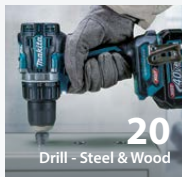

2024/25
GENERAL CATALOGUE

PRODUCT CATEGORY



20 Drill - Steel & Wood

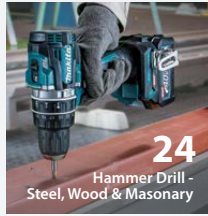

24 Hammer Drill - Steel, Wood & Masonry



26 Impact Driver



29 Impact Wrench



32 Screwdriver



Mixer 33



35 Rotary Hammer



34 Stationary Drill



41 Demolition Hammer



43 Recipro Saw



45 Cutting-Masonry & Concrete



47 Metal Cutting



Grinder 51



Sawing 63



65 Circular Saw

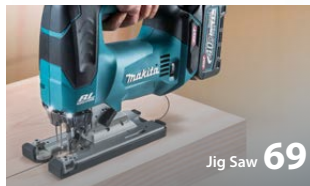

Jig Saw 69



71 Planing & Routing



78 Dust Extraction

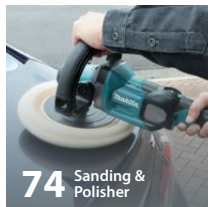

74 Sanding & Polisher

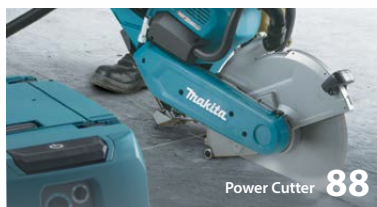

Power Cutter 88



88 Pressure Washer



90 Heat Gun

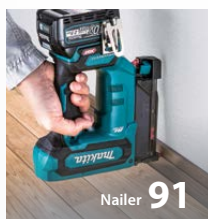

Nailer 91



93 Speciality Tools



97 Comfort/Lifestyle



96 Measuring/Leveling



107 OPE Tools



101 Lights



124 Cordless Tools For Industry



129 MT Series

Index		C		D		D	
1		CL001GZ12(Z/T+W)	85	DFN350ZJ	92	DMC300RTJ	45
1805N	71	CL002GZ03(ZB)	85	DFT023FNZ	125	DMC300Z	45
1911B	71	CL002GZ07(ZW)	85	DFT024FNZ	125	DML805	101
2		CL003GD114(RDW)	85	DFT025FNZ	126	DML807	105
2012NB	72	CL003GD115(RDB)	85	DFT045FNZ	125	DML809	101
2107FK	48	CL003GZ09(ZB)	85	DFT060FNZ	126	DML810	104
2416S	50	CL003GZ14(ZW)	85	DFT060TNZ	126	DML811	101
2712	65	CL100DW	86	DFT085FNZ	126	DML812	104
3		CL106FDSA / FDZ	86	DFT087FNZ	126	DML813	102
3601B	73	CLX224SAX1	21	DFT120TNZ	126	DML814	102
3711	73	CP100DSA / DZ	95	DFT127FNZ	126	DML815	104
4		CS002GZ	47	DFT129FNZ	126	DML816	105
4100KB	46	CW001GZ	99	DG001GZ02	123	DML817	105
4100NH	46	CW002GZ	98	DGA406RTE / RFE / ZK / Z	56	DMP180Z	96
4100NH3Z	46	CW003GZ	99	DGA408RTJ1 / Z	56	DMR057	100
4100NH3Z/B	46	CW004GZ NEW	98	DGA413RTE / Z	56	DMR108	100
4107R	46	D		DGA417RTE	56	DMR300	100
4112HS	46	DA3010F	23	DGA417Z	56	DP4002/B	23
4114S	46	DA333DSAE / DZ	23	DGA419Z	56	DP4700	23
4114S/B	46	DAS180Z	80	DGA469Z	55	DPB180Z	48
4131	47	DBO180Z	74	DGA506RTE / Z	55	DPB182Z	48
4131/B	47	DBO380RTJ / Z	76	DGA508RTE / Z	55	DPB183Z	48
4327M	70	DBO481RTJ / Z	77	DGA513RTE / Z	55	DPB184Z	48
4403	73	DBS180Z	77	DGA517RTE / Z	55	DPJ180Z	72
5		DCC500RTE / Z	45	DGD800Z	61	DPO600RTE / Z	74
5008MG	69	DCF102ZX1	98	DGP180Z	93	DPP200ZK	49
5103N	69	DCF203Z	98	DHG180ZK	90	DPT353RTE / Z	91
5806B	68	DCF301Z	98	DHG181ZK	90	DPV300RTJ / Z	75
5806B/B	68	DCG180ZB	95	DHK180Z	41	DRC200Z	84
6		DCL184Z	84	DHP453RFX4 / RYE	25	DRC300Z	83
6305	23	DCL280BX12 / FZB	86	DHP482RTE / RFX1 / RFE / Z	24	DRT50Z	72
6412	23	DCL283FRTB / FZB	85	DHP484RTE / RFE / Z	24	DRT52Z NEW	73
6412/B	23	DCL284FRTB / FZB	85	DHP486RTE / Z	24	DRV250Z	93
6413	23	DCL286FRTB / FZB	85	DHP487RFJ / Z	25	DS4011	23
6906	30	DCO181Z	72	DHP489RTJ / Z NEW	24	DSC163ZK	48
9		DCS552Z	47	DHR183RTWJ / Z	38	DSC191Z	49
9031	77	DCS553Z	47	DHR202RTE / Z	38	DSC251ZK	47
9035H	77	DCU180Z	112	DHR242RTE / Z	37	DSL800Z	74
906/B	62	DCU601Z NEW	111	DHR400ZKN	37	DSL801Z	74
9218SB	76	DCU602Z NEW	111	DHS660Z	67	DSP600Z	66
9237C	75	DCU603Z	112	DHS661RGJ / Z	67	DSP601Z	66
9500NB	56	DCU604Z	112	DHS710Z	67	DSS501RTE / Z	68
9556HNG	57	DCU605Z	112	DHS900Z	67	DSS610RTE / Z	68
9556HP/BX	57	DDA351Z	22	DHW080ZK	88	DST121ZK	93
9556HPG	57	DDF083RFE / Z	22	DJN161Z	51	DST221Z	93
9557HNG	58	DDF458RTE / RFE	20	DJR183RTE / Z	44	DST421ZK	93
9924DB	77	DDF482RTE / RFE / Z	20	DJR186RTE / ZK	44	DTC100ZK NEW	94
A		DDF484RTE / RFE / Z	20	DJR187RTE / ZK	43	DTC101ZK NEW	94
AC001GZ NEW	94	DDF486RTE / RFE / Z	20	DJR188RTJ / Z	44	DTD152RTE / RFE / Z	27
AF301	92	DDF487RFJ / Z	21	DJR189RTJ / Z	44	DTD153RTE / Z	27
AF506	92	DDF489RTJ / Z NEW	21	DJR360Z	43	DTD154RTE / Z	27
AS001GZ02	80	DDG460ZX4	123	DJS101Z	50	DTD156SYE / ZK	27
AT1022AZ	93	DF001DW	22	DJS130Z	50	DTD157RTJ / Z	27
B		DF001GM201(RM2J) / GD201(RD2J) / GZ	20	DJS161Z	50	DTD172RFJ / RTE / Z	27
BO3710	77	DF002GD201(RD2J) / GA201(SA2J) / GZ	20	DJV182RTE / Z	70	DTDA040Z	128
BO4510H	77	DF012DSE	22	DJV184RTJ / Z	70	DTDA070Z	128
BO4556	77	DF0300	22	DKP181Z	71	DTDA140Z	128
BO5031	75	DF032DSAE / DZ	22	DLM230RG / Z	120	DTL061Z	28
BO6050J	74	DF033DZ	22	DLM330RG	120	DTL063Z	31
C		DF330DWE	21	DLM382CF2 / Z	120	DTM51Z	95
CA5000X	51	DF332DSAE / DZ	21	DLM460Z	120	DTM52RTJX2 / Z	94
CC301DSYE	46	DF333DSAE / DZ	21	DLM462Z	119	DTR181Z	94
CE001GZ01	88	DF488D002 / D004 / DYEX4	21	DLM462Z	119	DT5141Z	28
CE002GZ	88	DFL020FZ	127	DLM480Z	119	DTW1001JX2 / Z	29
CF001GZ	98	DFL063FZ	127	DLM481Z	119	DTW1002JX2 / Z	29
CF002GZ	97	DFL083FZ	127	DLM530Z	119	DTW190RFE / Z	30
CF003GZ NEW	97	DFL302FZ	127	DLM532Z	119	DTW251RTE / Z	30
CG100DZA	95	DFL402FZ	127	DLM533Z	119	DTW300RTJ / RFJ / Z	30
CL001GD115(RD/T+B)	85	DFL650FZ	128	DLM538Z	119	DTW450RTE / Z	30
CL001GD126(RD/T+W)	85			DLM539Z	119	DTW700RTJ / Z	30
CL001GZ04(Z/T+B)	85			DLW140Z	49	DTW800RMJ	29
				DLX2131JX7	21		

D	
DTWA070Z	128
DTWA100Z	129
DTWA140Z	129
DTWA190Z	129
DTWA260Z NEW	129
DUA301ZB	110
DUB184Z	79
DUB185Z	80
DUB186Z	80
DUB187Z	79
DUB362Z	79
DUB363ZV	79
DUC150Z NEW	109
DUC254Z	109
DUC306ZB	109
DUC353ZB	108
DUC355Z	108
DUC357ZX4	109
DUH502Z	113
DUH506Z	113
DUH507F001 / Z	113
DUH601Z	113
DUH604SZ	113
DUH606Z	113
DUH751Z	113
DUH754SZ	112
DUM111SYX	115
DUM604SF / Z	114
DUN461WSF / WZ	114
DUN500WZ	114
DUP361ZN	122
DUR181Z	117
DUR189Z	116
DUR193SF / Z	116
DUR1945FX2	116
DUR368LZ	116
DUR369LZ	116
DUS054Z	122
DUS108Z	122
DUS158Z	122
DUT130Z	33
DUX18Z	108
DUX60Z	107
DVC150LZ	81
DVC155LZX2	81
DVC350Z	86
DVC560PGZ / Z	82
DVC660ZX7	83
DVC665Z	83
DVC750LZX1	84
DVC860LZ	81
DVC865LZX2	82
DVC867LZX4	82
DVF104Z	123
DVF154Z	123
DVP180Z	94
DVP181ZK	94
DWR180RF / Z	31
DWT310ZK	32
ELM3320	121
ELM3720	120
ELM4121	120
ELM4620	120
F	
FN001GD101(RDK) / GZ	92
FS2500	32
FS2700	32
FS4300	32
G	
GA003GM201(RM2J) / GD201(RD2J) / GZ	54

G	
GA004GZ	54
GA005GZ	53
GA011GD201(RD2J) / GZ	54
GA012GZJ / GZ	54
GA013GZJ / GZ	52
GA022GZJ / GZ	54
GA023GZJ / GZ	52
GA027GZJ / GZ	54
GA028GZJ / GZ	53
GA029GZJ / GZ	52
GA035GZ	52
GA036GZ	52
GA037GZ	51
GA038GZ	51
GA042GZJ / GZ	54
GA044GM201(RM2J) / GD201(RD2J) / GZ	52
GA048GZ NEW	54
GA050GZ NEW	52
GA051GZ NEW	52
GA4030	57
GA4031	57
GA4034	58
GA4040	57
GA4040C	57
GA4041C	58
GA4050R	57
GA4100 NEW	57
GA4593X01	58
GA4595	59
GA5010	59
GA5010/B	59
GA5030	59
GA5034	59
GA5050R	59
GA5080R	59
GA5091X01	60
GA5100 NEW	59
GA6010	60
GA6010X3/B	60
GA6020C	60
GA7020	60
GA7060	60
GA7060R/B	60
GA7070X1	60
GA7070X1/B	60
GA7081	60
GA7090 NEW	60
GA9020	61
GA9060	61
GA9070X1	61
GA9081	61
GA9090 NEW	61
GB602	62
GB801	62
GD0600	61
GD0600/B	61
GD0601	61
GD0602	62
GD0603	62
GD0603/B	62
GD0800C	62
GS5000	62
GV6010	76
H	
HB350	34
HB500	34
HB500/B	34
HG5030	90
HG6030K	90
HG6031VK	91

H	
HG6530VK	91
HG6531CK	91
HK1820	41
HM001GM204(RM2K) / GZ03(K)	41
HM002GZ03	41
HM0810A	41
HM0810TA	42
HM0810TA/B	42
HM0870C	42
HM0870C/B	42
HM0871C	42
HM1205C	42
HM1213C	42
HM1214C	42
HM1214C/B	42
HM1306	42
HM1306/B	42
HM1501	42
HM1511	43
HM1812	43
HM1812/B	43
HP001GM201(RM2J) / GD201(RD2J) / GZ	24
HP002GD201(RD2J) / GA201(SA2J) / GZ	24
HP0300	25
HP1630	25
HP1630/B	25
HP2050	26
HP2070	26
HP330DWE	25
HP332DSAE / DZ	25
HP333DSAE / DWYE / DYEX4 / DZ	25
HR001GD201(RD2J) / GZ	36
HR002GM201(RM2J) / GZ	36
HR003GM201(RM2J) / GZ	36
HR004GM201(RM2J) / GZ	36
HR005GM201(RM2J) / GZ	35
HR006GZ(K)	35
HR007GM201(RM2J) / GZ	36
HR008GM201(RM2J) / GZ	35
HR009GM201(RM2J) / GZ	35
HR010GD201(RD2J) / GZ NEW	36
HR166DSAE1 / DZ	38
HR1840J	38
HR2020	38
HR2300/B	38
HR2470X5	39
HR2470X5/B	39
HR2630/B	39
HR2630X3	39
HR2810	39
HR2810/B	39
HR3001CJ	39
HR3011FCJ	40
HR3200C	40
HR4002	40
HR4002/B	40
HR4003C	40
HR4003C/B	40
HR4013C	40
HR4501C	40
HR5202C	40
HR5202C/B	40
HR5212C	40
HS003GM201(RM2) / GZ	67
HS004GM201(RM2) / GZ	67
HS009GZ	66
HS010GZ	66
HS012GZ	67
HS0600	69

H	
HS300DW / DZ	68
HS301DWAE / DZ	68
HS6600	68
HS7010	68
HS7600	68
HW001GZ NEW	88
HW102	89
HW1300	89
HW132	89
HW151	89
J	
JN1601	51
JN3201J	51
JR001GM201(RM2J) / GD201(RD2J) / GZ	43
JR002GM201(RM2J) / GD201(RD2J) / GZ	43
JR103DWYE	44
JR3051TK	44
JR3061T	44
JR3070CT	44
JR3070CT/B	44
JS1300	50
JS1601	50
JS1602	50
JS3201J	50
JV002GM201 / GZ NEW	69
JV0600K	70
JV101DSAE / DZ	70
JV103DSAJ / DZ	70
K	
KP001GZ	71
KP0800X	71
L	
LB1200F	65
LC1230	48
LC1230/B	48
LCT204	21
LD030P	97
LD050P	97
LD080P	97
LH1201FL	64
LM001CZ	119
LM001GZ	118
LM001JM101	117
LM002GZ	118
LM002JM101	117
LM003GZ NEW	118
LM004GZ NEW	118
LM004JZ	117
LS002GZ	63
LS003GZ	63
LS004GZ	63
LS0714	63
LS1018L	63
LS1019L	63
LS1040	64
LS1110F NEW	64
LS1219L	64
LS1440	64
LW1401	49
LW1401/B	49
M	
M0600B	130
M0801B	130
M0801BX1	130
M0900B	131
M0910B	131
M0920B	132
M0921B	132
M1902B	134

M		R		U			
M2300B	133	RP0900	73	UR013GZ03	115		
M2401B	131	RT001GM202(RM2J) / GZ04	72	UR017GZ	116		
M3600B	134	RT0700C / CX2	73	UR100DWA / DZ	117		
M3601B	133	S		UR202CZ	116		
M3700B	133	SG1251J	46	UR3000	117		
M4000B	134	SJ401	65	US053DZ	123		
M4001B	134	SK105GDZ	97	UT001GZ	33		
M4100B	131	SK10GDZ	96	UT1301	34		
M4301B	133	SK40GDZ	96	UT1305	34		
M4302B	133	SK700GD	96	UT1305/B	34		
M4500B	133	SP001GZ	65	UV001GZ NEW	121		
M5801B	133	SP6000J	66	UX01GZ	107		
M6001B	129	ST002GZ NEW	92	V			
M6500B	129	T		VC003GLZ	81		
M6600XB	130	TB131	34	VC004GLZ	81		
M8100B	130	TD001GM201(RM2J) / GD201(RD2J) / GZ	26	VC006GMZ03	81		
M8103B	130	TD002GZ01	26	VC008GZ04	82		
M8103KX2B	130	TD003GA201 / GZ	27	VC009GZ	82		
M8600B	131	TD0101F	28	VC011GZ NEW	82		
M8700B	130	TD022DSE	28	VC2000L	85		
M8701B	130	TD043DNZ	128	VC2510L	85		
M9002B	132	TD063DNZ	128	VC3210L	84		
M9100B	132	TD090DWE	28	VC3210L/B	84		
M9200B	134	TD110DSAE/ DWYE / DZ	28	VS001GZ NEW	83		
M9203B	134	TD111DSAE / DZ	28	W			
M9204B	134	TL064DZ	28	WR100DSAEK / DZ	31		
M9400B	134	TM3010CX6	95	WT001GZ NEW	32		
M9506B	131	TW001GM204(RM2JX) / GD203(RD2JX) / GZ	29				
M9508B	132	TW004GM202(RM2J) / GD201(RD2J) / GZ	29				
M9509B	131	TW007GM201(RM2J) / GZ	29				
M9510B	132	TW0200	30				
M9512B	131	TW0350	30				
M9513B	132	TW0350/B	30				
ML001G	104	TW1000	31				
ML002G	104	TW1000/B	31				
ML003G	101	U					
ML005GX	101	UA001GM102(RM) / GZ01	110				
ML006G	105	UA002GM102(RM) / GZ01	110				
ML007G	104	UB001CZ	79				
ML009G	101	UB001GM201(RMX) / GZ	78				
ML010G	102	UB002CZ01	79				
ML011G	105	UB003CZ NEW	78				
ML106	104	UB100DZ	80				
ML107	105	UB101DZ	80				
MLT100	65	UB1102	80				
MP001GZ	95	UB1103	80				
MP100DZ	96	UB1103/B	80				
MR002G	100	UC003GZ01	108				
MR006G	100	UC012GT101(RT) / GZ	108				
MR010G	100	UC014GT101(RT) / GZ	108				
MW001GZ NEW	99	UC015GT101(RT) / GZ	108				
N		UC022GZ NEW	108				
N3701	73	UC100DZ	109				
N5900B	69	UC3541A	110				
P		UC3551A	110				
PB002GM201(RM2K) / GZ	48	UC4041A	110				
PC5000C/B	76	UC4051A	110				
PC5010C	76	UC4551A	110				
PC5010C/B	76	UH006GZ	112				
PDC01 (191A62-6 / 191A67-6)	19	UH014GM101(RM) / GZ	112				
PDC1200A01 / A02	19	UH201DZ	114				
PDC1500A01 NEW	19	UH353DSA / DZ	114				
PJ7000	72	UM600DSYEX / DWA / DZ	115				
PK5001C	76	UN460WDWA / WDZ	114				
PM001GT202(PT2) / GZ01 NEW	123	UP100DZ NEW	122				
PO6000C	74	UR003GZ	115				
PT001GD201(RD2K) / GZ	91	UR008GM101(RM) / GZ01	115				
PT354DZ	92	UR012GZ04	115				
PV001GM101(RMX) / GZ	75						
PV301DSAE / DZ	75						
PV7000C	75						

Safety Precautions

When using electric tools, basic safety precautions should always be followed to reduce the risk of fire, electric shock, and personal injury, including the following.

/// KEEP WORK AREA CLEAN.

Cluttered areas and benches invite injuries.

/// CONSIDER WORK AREA ENVIRONMENT.

Don't use power tools in damp or wet locations. Keep work area well lit. Don't expose power tools to rain. Don't use power tool in presence of flammable liquids or gases.

/// KEEP CHILDREN AWAY.

All visitors should be kept away from work area. Don't let visitors touch the tool or extension cord.

/// STORE IDLE TOOLS.

When not in use, tools should be stored in a dry, high of locked up place, out of reach of children.

/// DON'T FORCE THE TOOL.

It will do the job better and safer at the rate for which it was intended.

/// USE THE RIGHT TOOL.

Don't force small tools or attachments to do the job of a heavy-duty tool. Don't use tools for purposes not intended.

/// DRESS PROPERLY.

Don't wear loose clothing or jewelry. They can be caught in moving parts. Rubber gloves and non-skid footwear are recommended when working outdoors. Wear protective hair covering to contain long hair.

/// USE SAFETY GLASSES.

Also use face or dust mask if the cutting operation is dusty.

/// DON'T ABUSE THE CORD.

Never carry the tool by the cord or yank it to disconnect it from the socket. Keep the cord away from heat, oil, and sharp edges.

/// SECURE WORK.

Use clamps or a vise to hold the work. It's safer than using your hand and it frees both hands to operate the tool.

/// DON'T OVERREACH.

Keep proper footing and balance at all times.

/// MAINTAIN TOOLS WITH CARE.

Keep cutting tools sharp and clean for better and safer performance. Follow instructions for lubrication and changing accessories. Inspect tool cord periodically and if damaged, have it repaired by an authorized service facility. Inspect extension cords periodically and replace, if damaged. Keep handles dry, clean and free from oil and grease.

/// DISCONNECT TOOLS.

When not in use, before servicing and when changing accessories such as blades, bits and cutters.

/// REMOVE ADJUSTING KEYS AND WRENCHES.

Form the habit of checking to see that keys and adjusting wrenches are removed from the tool before turning it on.

/// AVOID UNINTENTIONAL STARTING.

Don't carry a plugged-in tool with a finger on the switch. Ensure switch is OFF when plugging in.

/// USE OUTDOOR EXTENSION CORDS.

When tool is used outdoors, use only extension cords intended for outdoor use.

/// STAY ALERT.

Watch what you are doing. Use common sense. Don't operate tool when you are tired.

/// CHECK DAMAGED PARTS.

Before further use of the tool, a guard or other part that is damaged should be carefully checked to determine that it will operate properly and perform its intended function. Check for alignment of moving parts, free running of moving parts, breakage of parts, mounting and any other conditions that may affect its operation. A guard or other part that is damaged should be properly repaired or replaced by an authorized service center unless otherwise indicated in this instruction manual. Have defective switches replaced by an authorized service facility. Don't use the tool if the switch does not turn it on and off.

/// GUARD AGAINST ELECTRIC SHOCK.

Avoid body contact with earthed or grounded surfaces (e.g. pipes, radiators, ranges, refrigerators).

/// REPLACEMENT PARTS.

When servicing a tool, use only identical replacement parts.

/// VOLTAGE WARNING:

Before connecting the tool to a power source (receptacle, outlet, etc.) Be sure the voltage supplied is the same as that specified on the nameplate of the tool. A power source with voltage greater than that specified for the tool can result in SERIOUS INJURY to the user V as well as damage to the tool. If in doubt, DO NOT PLUG IN THE TOOL. Using a power source with voltage less than the nameplate rating is harmful to the motor.

Note

- Makita reserves the right to change specifications of parts and accessories without notice.
- Items of standard equipment and specifications may vary by country or area.
- Net weight and dimensions may differ by the type of battery.
- Standard export color for motor housing is Makita industrial green (blue).
- Please state required voltage when ordering. These offers are subject to availability in each country. Actual product color may differ slightly from color reproduced here.
- Weight data in this catalogue is the value measured by us according to EPTA Procedure 01/2003.

Warranty

Every **MAKITA** tool is thoroughly inspected and tested before leaving the factory. Subject to the following Terms and Conditions from the date of purchase, this tool is **warranty against defective materials and manufacturing defects for a period of 6 MONTHS for AC and non brushless DC tools. As for brushless DC tools it will be a period of 12 MONTHS. Same goes to Makita charger warranty, against defective materials and manufacturing defects for a period of 12 MONTHS. As for Makita Light will be a period of 6 MONTHS.**

The period and conditions of our warranty as follows:

1. Sales receipt must be presented when servicing or warranty is required.
2. Warranty ONLY cover tools distributed by Makita Singapore Pte. Ltd. Warranty does not cover tools purchased overseas or distributed by other countries.
3. **This warranty is valid base on the original purchase receipt with "Date of Purchase", "Model Number" & "Serial Number".**

This warranty will be null & void in any of the following events during the warranty period:

1. The product unit has undergone repair, attempted repair, dismantle or modification in any way whatsoever by any other person.
2. Damage resulting from use of improper accessories, non-genuine replacement parts, disassembly, tampering, alternation and repairing in any way that affects the reliability and performance.
3. Damage resulting from negligence, accident, disaster, improper storage or maintenance, abuse and misuse in evident caused by overloading the tool beyond its capacity.
4. Abnormal voltage or usage of generator, wrong usage not in accordance with the Operation Manual.
5. If the Serial Number on the tool, seal on the battery and charger has been defaced or removed.
6. If any information on the warranty card has been defaced, removed, altered, unreadable or unclear (date of purchase, Serial Number, etc.)

** Makita reserved the rights of amend conditions of warranty without prior notice.

Please visit our website for Makita's Service Centre information

<http://www.makita.com.sg/servicing-the-customer>

Tool ◀▶ Battery ◀▶ Battery Charger
Digital communication

XGT is a new system with its own tools, batteries, and chargers. A combination of innovative tool design and higher output batteries provide a genuine solution for high demand industrial users.

Optimum power supply system and Optimum charging system

The XGT range of tools and batteries come with a built-in program, providing digital communication between the battery and tool. Allowing not only for the battery to talk with tool but also the tool to talk to the battery. Battery technology and motor engineering that work together for optimum performance.



Optimum charging system

Auto maintenance system with two cooling fans for providing more optimum fast charging

Built Tough

High durability specifications specially designed for 40Vmax Li-Ion batteries

4-LED fuel gauge indicator

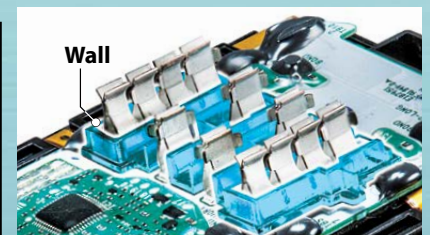
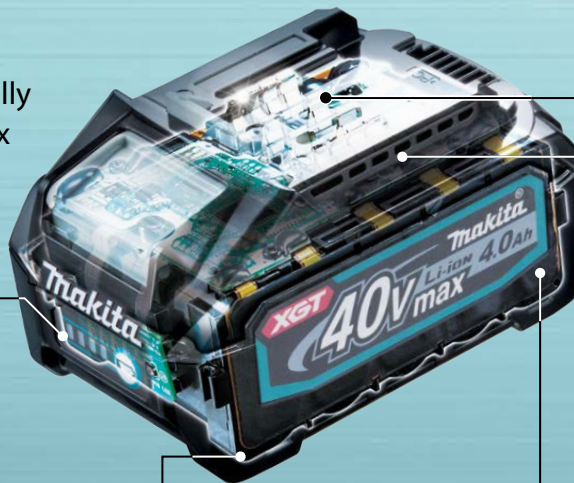

Terminal short-circuit prevention structure
The protection wall is provided between terminals against water and dust.

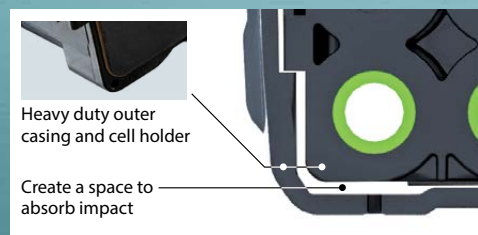

Heavy duty outer casing and cell holder
Create a space to absorb impact

Shock absorption structure

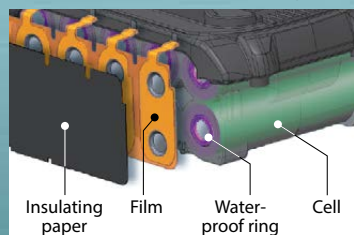

Waterproof Triple-layer Structure
prevents cell failure due to water and dust.

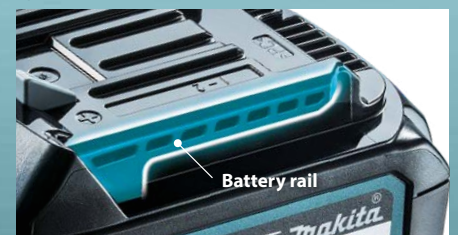

High Rigidity Battery Rails
Durable slide in battery rail that holds the battery and the tools firmly and securely to withstand high power products

40Vmax mechanism movie

This movie was filmed in Japan.
Models and specs may vary by country.



Rapid Optimum Charging System

It is necessary to cool down before start charging when the battery temperature is high.
Built-in fan circulates air through the battery before start charging and during the charging process to cool the battery for faster charge time.

The Makita Rapid Optimum Charger communicates with the battery's built-in chip throughout the charging process to optimize battery life by actively controlling current, voltage and temperature.

The optimum charging system
Forced air cooling



Fast charging



General charging method
Natural heat dissipation

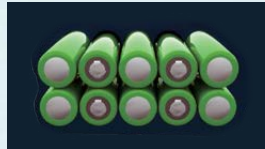

Waiting time for charging

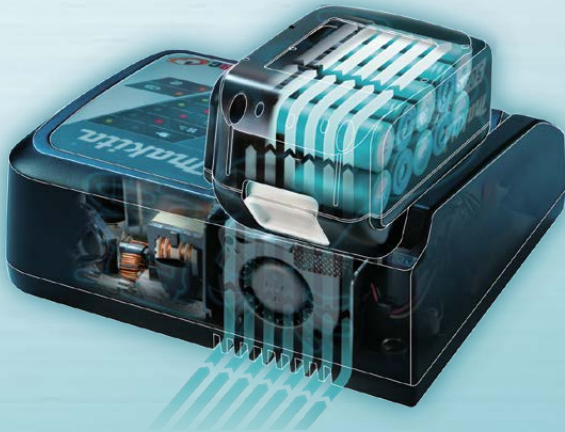

The optimum charging system

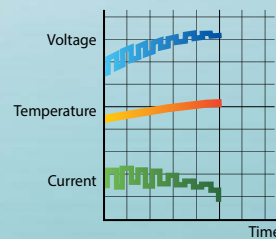

General charging method

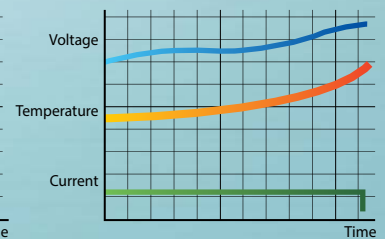

Battery Protection Function

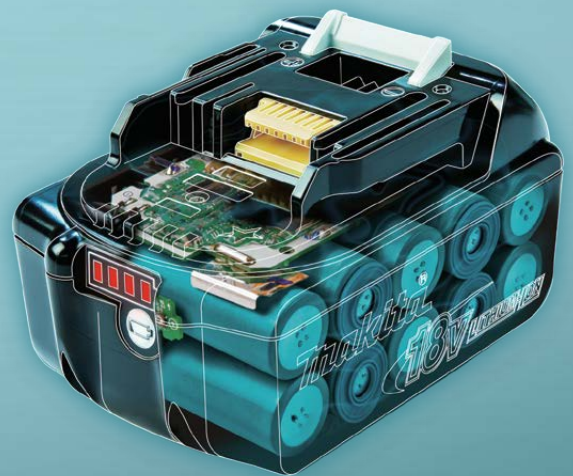
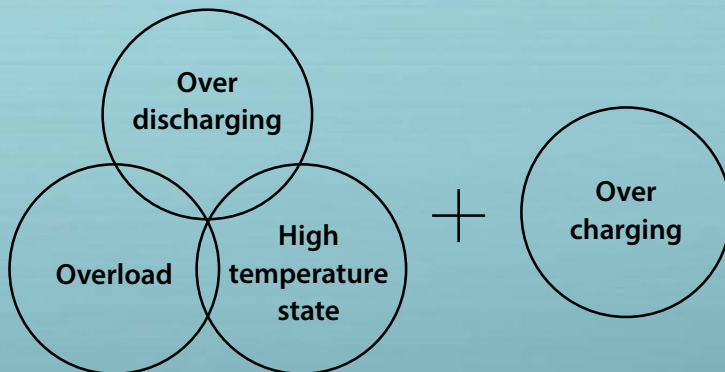

This function is communication technology that allows the tool and battery to monitor conditions and exchange data in real time to protect against Overload, Over-Discharge and Overheating.

Firm Holding

Multi-contact terminals reduce electrical resistance and increase connection stability withstanding against vibration, and ultimately ensures Stable current supply to the tool.

Anytime Charge
No Memory Effect
No discharging required



Shock Absorbing
Heavy Duty Pack

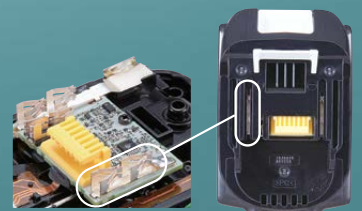

Li-ion Battery & Charger Time Reference, Compatibility Chart

40Vmax		18V		Fast Charging		DC40RC	Fast Charging		Fast Charging		DC18SD	
40Vmax Lithium-ion		18V Lithium-ion		DC40RA		DC40RC	DC40RA + ADP10		DC40RC + ADP10		DC18RC	
XGT		LXT		(191E08-6)		(191M92-9)	(191C11-5)		(191C11-5)		(195586-8)	
				(191N14-5)			Compatible with LXT Li-Ion batteries		Compatible with LXT Li-Ion batteries		(19582-6)	
											DC18SH*	
											DC18SE (Automotive)	
											(194621-9)	
40Vmax Lithium-ion XGT	8.0Ah BL4080F (191X65-8)	76min.	170min.	-	-	-	-	-	-	-	-	-
	5.0Ah BL4050F (191L47-8)	50min.	85min.	-	-	-	-	-	-	-	-	-
	4.0Ah BL4040F (191N06-8) BL4040 (191B26-6)	45min.	67min.	-	-	-	-	-	-	-	-	-
	2.5Ah BL4025 (191B36-3)	28min.	38min.	-	-	-	-	-	-	-	-	-
	2.0Ah BL4020 (191L29-0)	22min.	30min.	-	-	-	-	-	-	-	-	-
18V Lithium-ion LXT	6.0Ah BL1860B (197422-4)	-	-	40min.	85min.	55min.	130min.	-	-	-	-	-
	5.0Ah BL1850B (197280-8)	-	-	35min.	70min.	45min.	110min.	-	-	-	-	-
	4.0Ah BL1840B (197265-4)	-	-	29min.	58min.	36min.	90min.	-	-	-	-	-
	3.0Ah BL1830B (197599-5)	-	-	22min.	42min.	22min.	60min.	-	-	-	-	-
	2.0Ah BL1820B (197254-9)	-	-	24min.	33min.	24min.	45min.	-	-	-	-	-
	1.5Ah BL1815N (196449-1)	-	-	15min.	22min.	15min.	30min.	-	-	-	-	-
12Vmax Lithium-ion CXT	5.0Ah BL1050B (1913G0-9)	75min.	160min.	40Vmax Lithium-ion 18V x2 Lithium-ion	35.5Ah PDC1200	360min.	43.55Ah PDC1500	450min.	40Vmax Lithium-ion 18V x2 Lithium-ion	Power by up to four 18V LXT Batteries	-	-
	4.0Ah BL1041B (197406-2)	60min.	130min.									
	2.0Ah BL1021B (197396-9)	30min.	70min.									
	1.5Ah BL1016 (197393-5)	22min.	50min.									
64Vmax Lithium-ion	10.0Ah BL64100 (191Y69-6)	300min.	10.8V Lithium-ion	1.3Ah BL1013 (196066-7)	50min.	G-Series		18V	14.4V	1.5Ah BL1815G (198186-3) BL1415G (198192-8)	70min.	
	4.0Ah BL6440 (191R06-8)	120min.	7.2V Lithium-ion	1.5Ah BL0715 (198000-3)	35min.			18V Lithium-ion	14.4V Lithium-ion	2.0Ah BL1820G (191N69-0)	90min.	

* DC40RB / DC18RD / DC18SH: Two Port Multi Fast Charger ** DC18RE: CXT & LXT Dual port Fast Charger

MAKPAC Power Source Kit



QADPSKG1 (191V23-2)	Fast Charger (DC40RC), 2X40Vmax - 2.0Ah Batteries (BL4020), Makpac	
QAEPSKG1 (191V31-3)	Fast Charger (DC40RC), 2X40Vmax - 2.5Ah Batteries (BL4025), Makpac	
MKP1G001 (191J85-8)	Rapid Charger (DC40RA), 2X40Vmax - 2.5Ah Batteries (BL4025), Makpac	
MKP1G002 (191K01-6)	Rapid Charger (DC40RA), 2X40Vmax - 4.0Ah Batteries (BL4040), Makpac	
MKPPSKG2 (191V42-8)	Rapid Charger (DC40RA), 2X40Vmax - 5.0Ah Batteries (BL4050F), Makpac	
QAAPSKG3 (191U06-6)	Dual Port Multi Rapid Charger (DC40RB), 2X40Vmax - 4.0Ah Batteries (BL4040), Makpac	
QABPSKG3 (191U20-2)	Dual Port Multi Rapid Charger (DC40RB), 2X40Vmax - 5.0Ah Batteries (BL4050F), Makpac	
QAPSKG3 (1910A2-5)	Dual Port Multi Rapid Charger (DC40RB), 2X40Vmax - 8.0Ah Batteries (BL4080F), Makpac	
QACPSKG3 (191U34-1)	Dual Port Multi Rapid Charger (DC40RB), 4X40Vmax - 4.0Ah Batteries (BL4040), Makpac	
QADPSKG3 (191U48-0)	Dual Port Multi Rapid Charger (DC40RB), 4X40Vmax - 5.0Ah Batteries (BL4050F), Makpac	

MAKPAC Power Source Kit



MKP1RF182 (197974-5)	Rapid Charger (DC18RC), 2X18V - 3.0Ah Batteries (BL1830B), Makpac	
MKP1RT182 (197803-2)	Rapid Charger (DC18RC), 2X18V - 5.0Ah Batteries (BL1850B), Makpac	
MKP1RG182 (198119-8)	Rapid Charger (DC18RC), 2X18V - 6.0Ah Batteries (BL1860B), Makpac	
MKP3PT182 (198182-1)	Dual Port Rapid Charger (DC18RD), 2X18V - 5.0Ah Batteries (BL1850B), Makpac	
MKP3PG182 (198081-7)	Dual Port Rapid Charger (DC18RD), 2X18V - 6.0Ah Batteries (BL1860B), Makpac	
MKP3PT184 (197627-6)	Dual Port Rapid Charger (DC18RD), 4X18V - 5.0Ah Batteries (BL1850B), Makpac	
MKP3PG184 (198095-6)	Dual Port Rapid Charger (DC18RD), 4X18V - 6.0Ah Batteries (BL1860B), Makpac	

MAKPAC Power Source Kit



MKP1SY122 (197654-3)	Fast Charger (DC10SB), 2X12Vmax - 1.5Ah Batteries (BL1016), Makpac	
MKP1SA122 (191K13-9)	Fast Charger (DC10SB), 2X12Vmax - 2.0Ah Batteries (BL1021B), Makpac	
MKP1SM122 (191K12-1)	Fast Charger (DC10SB), 2X12Vmax - 4.0Ah Batteries (BL1041B), Makpac	

XGT

40V Li-ion max

High Power

Durability

Digital Communication

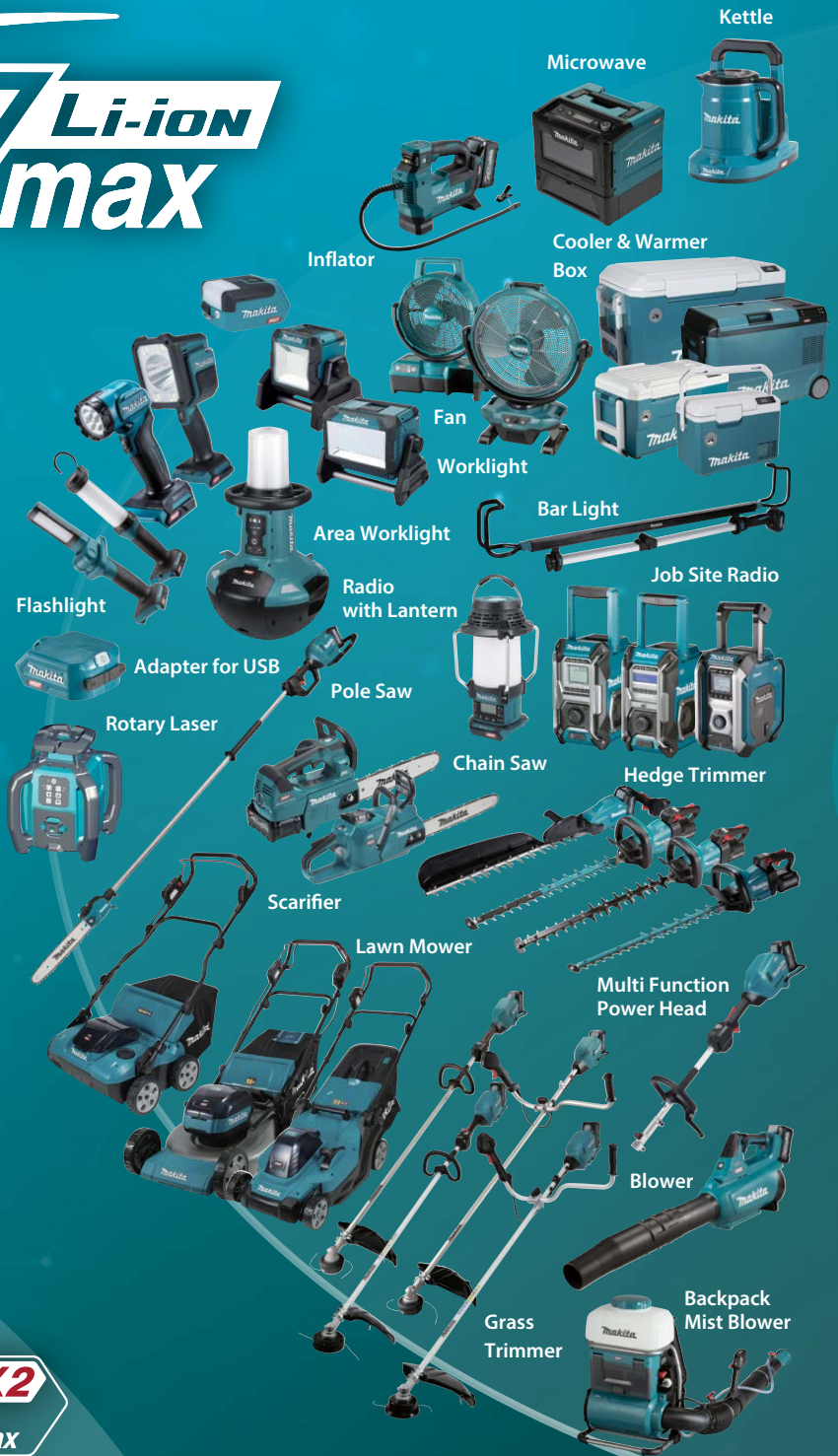

XGT

40V Li-ion max

XGT X2
80V max

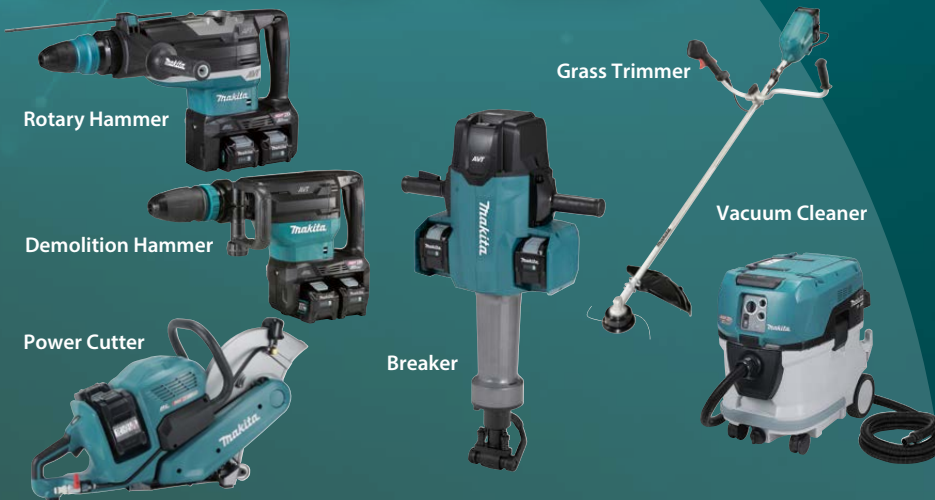

Battery

BL4020
2.0Ah

BL4025 /
BL4025F
2.5Ah

BL4040 /
BL4040F
4.0Ah



Impact Driver



Driver Drill



Hammer Driver Drill



Rotary Hammer



Demolition Hammer



Combination Hammer



Shear Wrench



Brad Nailer



Impact Wrench



Angle Drill



Polisher



Air Compressor



Communication connector



Earth Auger



Mixer



Concrete Vibrator

Rear Handle Saw



Angle Grinder



Circular Saw



Plunge Cut Saw



Slide Compound Miter Saw



210+ TOOLS



Random Orbit Sander



Orbital Sander



Metal Cutter



Recipro Saw



Steel Rod Cutter



Steel Rod Cutter



Dust Blower



Backpack Vacuum Cleaner



Planer



Jig Saw



Portable Band Saw



High Pressure Washer



Vacuum Cleaner



Upright Cleaner



Cleaner



Trimmer



^ Some models are not for local sale

Charger

BL4050F
5.0Ah



BL4080F
8.0Ah



DC40RA



DC40RB



DC40WA



DC40RC



ADP10



Adapter for LXT Battery

18V LITHIUM-ION



18V Lithium-ion

- Recipro Saw
- Rear Handle Saw
- Portable Cut-off
- Plunge Cut Saw
- Power Cutter
- Angle Grinder
- Rotary Hammer
- Combination Hammer
- Slide Compound Miter Saw
- Circular Saw
- Wall Scanner
- Caulking Gun
- Heat Gun
- Vacuum Pump
- Grease Gun
- Angle Drill
- Shear Wrench
- Backpack Vacuum Cleaner
- Fan Jacket
- Heated Jacket
- Heated Base Layer Shirt
- Cooler & Warmer Box
- Coffee Maker
- Inflator
- Upright Cleaner
- Fan Vest
- Heated Vest
- Worklight
- Heated Blanket
- LED Worklight
- Fan
- Rotary Laser
- Bar Light
- Radio with Lantern
- Job Site Speaker
- Worklight
- Flashlight
- LED Flashlight
- Pruning Shears
- Job Site Radio
- Pruning Saw
- Blower
- Blower Vacuum
- Wheelbarrow
- Chain Saw
- Lawn Mower
- Brad Nailer
- Planer
- Hedge Trimmer
- Grass Shear
- Garden Sprayer
- String Trimmer
- Portable Vacuum Cleaner
- Robotic Cleaner
- Vacuum Cleaner
- Rebar Tying Tool
- Rivet Gun
- Grass Trimmer
- Cleaner
- Dust Blower
- Drywall Saw
- Circular Saw
- Multi Function Power Head
- Cyclone Cleaner
- Vacuum Cleaner
- Stapler
- Cut-Out Tool
- Pin Nailer
- Finish Nailer
- Plate Joiner
- Jig Saw





Chain Saw Pole Saw

Pruning Shears

Grass Trimmer

Earth Auger

Lawn Mower

Vacuum Pump

High Pressure Washer

Wheelbarrow

Portable Power Pack

Impact Wrench

Vacuum Cleaner

Blower

Kettle

Hedge Trimmer

Multi Function Power Head

Mixer

Concrete Vibrator

4 Mode Impact Driver

Screwdriver

Driver Drill

Oil-Pulse Driver

Auto Feed Screwdriver

Angle Impact Wrench

Impact Driver

Angle Drill

Angle Impact Driver

Ratchet Wrench

Hammer Driver Drill

Rotary Hammer

Die Grinder

Sander Polisher

Power Scraper

Combination Hammer

Steel Rod Cutter

Multi Tool

Random Orbit Polisher

Angle Grinder

Recipro Saw

Metal Shear

Finishing Sander

Drywall Sander

Random Orbit Sander

Threaded Rod Cutter

Compact Cut Off

Hole Puncher

Belt Sander



Nibbler

Cable Cutter

Cutter

Metal Cutter

Portable Band Saw

Slide Compound Miter Saw

Compound Miter Saw

18V x2

440+ TOOLS

6.0Ah 5.0Ah 4.0Ah
3.0Ah 2.0Ah 1.5Ah

^ Some models are not for local sale

Expand Your Lithium Line Up

12V_{max} LITHIUM-ION

100+ TOOLS
4.0Ah 2.0Ah 1.5Ah

EXPAND YOUR LITHIUM-ION LINEUP

- Driver Drill
- Hammer Driver Drill
- Impact Driver
- Angle Drill
- Impact Wrench
- Rotary Hammer
- Ratchet Wrench
- Circular Saw
- Multi Cutter
- Threaded Rod Cutter
- Cutter
- Angle Impact Driver
- Recipro Saw
- Drywall Saw
- Multi tool
- Pin Nailer
- Multi tool
- Jig Saw
- Stapler
- Sander Polisher
- Garden Sprayer
- Caulking Gun
- Pruning Shears
- Pruning Saw
- Hedge Trimmer
- Blower
- Grass Trimmer
- Grass Shear
- Blower
- Inflator
- Blower
- Worklight
- LED Worklight
- Cordless Cleaner
- Fan Jacket
- Fan Vest
- Fan
- Heated Jacket
- Heated Vest
- Heated Base Layer Shirt
- Heated Blanket
- Red 4-point Cross Line Laser
- Green Multi Line Laser
- Multi Line Laser
- Green 4-point Cross Line Laser
- Rotary Laser
- Job Site Speaker
- Job Site Radio
- Adapter for USB



^ Some models are not for local sale



10.8V Lithium-ion



7.2V Lithium-ion



^ Some models are not for local sale

A wide variety of Lithium-ion Garden Tools

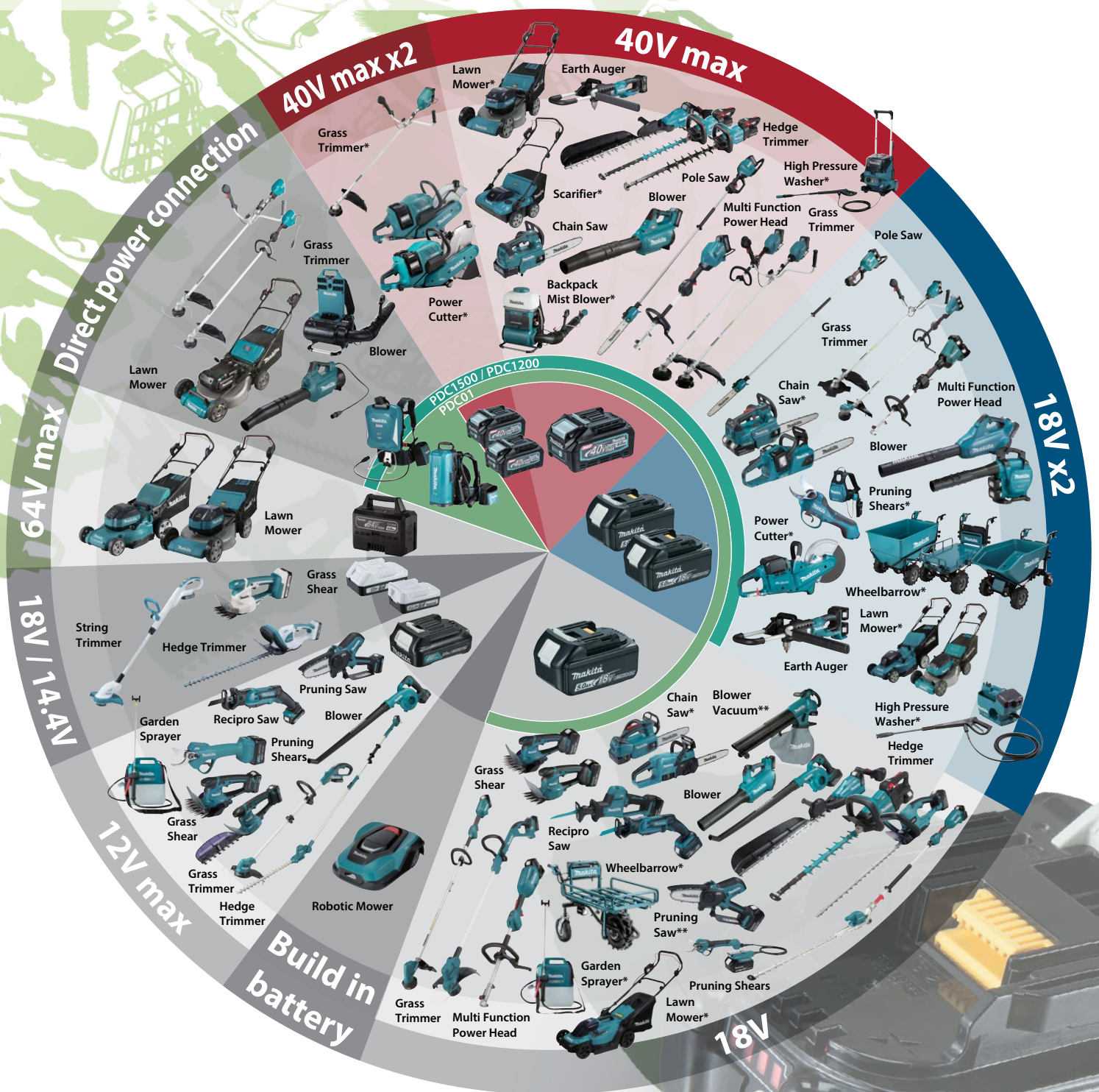

* These models are not compatible with Portable Power Pack (PDC1500, PDC1200, PDC01)
 Only rear handle type chainsaws are compatible
 ** These models are not compatible with Portable Power Pack (PDC1500, PDC1200)
 ^ Some models are not for local sale



Portable Power Pack

1,500Wh-class high capacity

Portable Power Pack
PDC1500

More robust appearance and increased strength

Achieved by:

- New stand with increased strength obtained by using a larger diameter metal pipe
- Metalized junctions between battery and harness



Height-adjustable waist belt



Quickly removable harness



Reflectors

Compatible with a wide range of applications
(both in backpack and stationary styles)



PDC1500



PDC1200



Charger DC4001

Part No. 191L01-2

Charging time

PDC1500: 450 min.

PDC1200: 360 min.



PDC01

Powered by up to four 18V LXT batteries
432 Wh high capacity
(with 4 pcs. of BL1860B)
(Batteries sold separately)



IPX4

PDC1200A01 / A02 Portable Power Pack

1,200 Wh high capacity



Capacity	33.5 Ah
Energy Capacity	1,206 Wh
Number of Cells	100
Charging Time (hours)	6
Power Supply Cord	Battery Side: 1.1 m (3.6 ft) Adapter Side: 0.6 m (2.0 ft)
Dimensions (L x W x H)	w/o Harness: 369 x 261 x 139 mm (14-1/2 x 10-1/4 x 5-1/2") w/ Harness: 428 x 261 x 164 mm (16-7/8 x 10-1/4 x 6-1/2")
Net weight	8.8 kg (19.4 lbs.)

40Vmax 18V x2 XGT LXT IPX4 WG

Harness, Adapter for 36V (18V x2) [countries-specific], Charger. * PDC1200A01 (1x 18V+18V Adaptor)

Power Converter

Transform DC power into AC power instantly!

- Power converter powered by Makita portable power pack
- Turns DC power into AC power, is optimal for a wide range of applications
- Battery charging or use of corded tools in outdoor job sites where AC outlet is not available
- Emergency power source of outdoor leisure activities
- 7-stage output indication by 7 LED lamps
- Can be connected firmly with accessories of MAKPAC system, allowing for easy transportation on MAKPAC trolley or cart



Power Converter
BAC01



PDC1500A01 Portable Power Pack

New

1,500Wh-class High Capacity, High Output Power



Capacity	43.55 Ah
Energy capacity	1,567.8 Wh
Number of cells	130
Charging time	450 min.
Dimensions (L x W x H)	w/o Harness: 369 x 312 x 131 mm (14-1/2 x 12-1/4 x 5-1/8")
Net weight	10.9 - 12.9 kg (24.0 - 28.4 lbs.)*
Power supply cord	Battery side: 1.2 m (3.9 ft) Adapter side: 0.6 m (2.0 ft)

40Vmax 18V x2 XGT LXT IPX4 WG 1

Harness, Charger *not covered by EPTA-Procedure

PDC01 (191A62-6 / 191A67-6) Portable Power Pack

Powered by up to four 18V LXT batteries

Li-ion Ah 6.0 | 5.0 | 3.0 | 1.5



Capacity	24 / 12 Ah
Energy Capacity	432 Wh
Dimensions (L x W x H)	400x195x132mm (15-3/4"x7-5/8"x5-3/16")
Net weight	1.7 kg (5.6 lbs.)

18V x2 18V XGT LXT IPX4

Harness, Adapter. * 191A62-6 (18V+18V and 18V Adaptor), 191A67-6 (18V + 18V Adaptor only)

DRILL

Steel & Wood

PRODUCTS



DF001GM201(RM2J) / GD201(RD2J) / GZ 13mm (1/2") Cordless Driver Drill

Excellent in Continuous Heavy-Duty Work

Li-ion Ah 8.0 | 5.0 | 4.0 | 2.5 | 2.0



DF001GZ
5
DF001GM201/
GD201
1

Capacity	Steel: 20 mm (13/16") Wood (Auger-Bit): 50 mm (2") Wood (Self-Feed Bit): 76 mm (3") Wood (Hole Saw): 152 mm (6")
Chuck Capacity	1.5 - 13 mm (1/16 - 1/2")
No Load Speed (RPM)	High / Low: 0 - 2,600 / 0 - 650
Max Fastening Torque	Hard / Soft: 140 / 68 N·m
Max lock torque	125 N·m (1,100 in.lbs.)
Dimensions (L x W x H)	w/BL402S: 181x86x275 mm w/BL404Q: 181x86x282 mm
Net weight	2.7 - 3.0 kg (5.9 - 6.6 lbs.)

40Vmax **XGT BL AFT XPT**

Side Handle, Belt Clip, (+/-) Bit, Bit Holder, Charger, Battery, Z: Battery and Charger are sold separately

DF002GD201(RD2J) / GA201(SA2J) / GZ 13mm (1/2") Cordless Driver Drill

Compact and ergonomic design at only 170 mm (6-11/16") long

Li-ion Ah 5.0 | 4.0 | 2.5 | 2.0



DF002GZ
4
DF002GD201/
GA201
1

Capacity	Steel/Wood: 13/38 mm (1/2"/1-1/2")
Chuck Capacity	1.5 - 13 mm (1/16 - 1/2")
No Load Speed (RPM)	High / Low: 0 - 2,200 / 0 - 600
Max Fastening Torque	Hard / Soft: 64 / 30 N·m (570 / 270 in.lbs.)
Max lock torque	65 N·m (580 in.lbs.)
Dimensions (L x W x H)	w/BL402S: 170x86x265 mm w/BL404Q: 181x86x290 mm
Net weight	1.9 - 2.8 kg (4.2 - 6.2 lbs.)

40Vmax **XGT BL AFT XPT**

(+/-) Bit, Belt Clip, Battery, Charger, Z: Battery and Charger are sold separately

DDF486RTE / RFE / Z 13mm (1/2") Cordless Driver Drill

18V LXT BL Brushless Cordless 13 mm (1/2") 125 N·m (1,100 in.lbs.)

Li-ion Ah 6.0 | 5.0 | 3.0 | 1.5



DDF486RTE
/ RFE
1
DDF486Z
3

Capacity	Steel: 13 mm (1/2"), Wood (Auger-Bit): 50 mm (2") Wood (Self-Feed Bit): 76 mm (3") Wood (Hole Saw): 152 mm (6"), Sliding Board: 170 mm (6-11/16")
Chuck capacity	1.5 - 13 mm (1/16 - 1/2")
No Load Speed (RPM)	High / Low: 0 - 2,100 / 0 - 550
Max Fastening Torque	Hard / Soft: 130 / 65 N·m
Max lock torque	125 N·m (1,100 in.lbs.)
Dimensions (L x W x H)	w/BL1830B/BL1850B/ BL1860B: 178 x 81 x 265 mm
Net weight	2.3 - 2.6 kg (5.1 - 5.7 lbs.)

18V **LXT BL XPT**

Depth Gauge, Side Handle, Belt Clip, (+/-) Bit, Bit Holder, Charger, Battery, Z: Battery and Charger are sold separately

DDF458RTE / RFE 13mm (1/2") Cordless Driver Drill

Cordless 13 mm (1/2") 84 N·m (750 in.lbs.) Driver Drill

440

Li-ion Ah 6.0 | 5.0 | 3.0 | 1.5



DDF458RTE
/ RFE
2

Capacity	Steel: 13 mm (1/2") Wood: 76 mm (3")
No Load Speed (RPM)	High: 0 - 2,000 Low: 0 - 400
Max Fastening Torque	Hard / Soft: 91 / 58 N·m
Max lock torque	84 N·m (750 in.lbs.)
Dimensions (L x W x H)	225x79x259 mm (8-7/8"x3-1/8"x10-1/4")
Net weight	2.1 - 2.5 kg (4.7 - 5.4 lbs.)

18V **LXT XPT**

Charger, Battery, (+/-) Bit, Side Grip, Z: Battery and Charger are sold separately

DDF484RTE / RFE / Z 13mm (1/2") Cordless Driver Drill

Cordless 13 mm (1/2") 60 N·m (530 in.lbs.) Driver Drill

Li-ion Ah 6.0 | 5.0 | 3.0 | 1.5



DDF484RTE
/ RFE
5
DDF484Z
6

Capacity	Steel / Wood: 13 / 38 mm (1/2" / 1-1/2")
Chuck capacity	1.5 - 13 mm (1/16 - 1/2")
No Load Speed (RPM)	High / Low: 0 - 2,000 / 0 - 500
Max Fastening Torque	Hard / Soft: 54 / 30 N·m (480 / 270 in.lbs.)
Max lock torque	60 N·m (530 in.lbs.)
Sound Power Level	N/A dB(A)
Dimensions (L x W x H)	172x79x261 mm (6-3/4"x3-1/8"x10-1/4")
Net weight	1.5 kg (3.4 lbs.)

18V **LXT BL XPT**

(+/-) bit 2-45, Belt clip, Battery, Fast Charger, Z: Battery and Charger are sold separately

DDF482RTE / RFE / Z 13mm (1/2") Cordless Driver Drill

Developed as the successor to the current model DDF456

440

Li-ion Ah 6.0 | 5.0 | 3.0 | 1.5



DDF482RTE
/ RFE
2
DDF482Z
8

Capacity	Steel / Wood: 13 / 38 mm (1/2" / 1-1/2")
Chuck capacity	1.5 - 13 mm (1/16 - 1/2")
No Load Speed (RPM)	High / Low: 0 - 1,900 / 0 - 600
Max Fastening Torque	Hard / Soft: 62 / 36 N·m (550 / 320 in.lbs.)
Max lock torque	54 N·m (480 in.lbs.)
Dimensions (L x W x H)	185x79x249 mm (7-1/4"x3-1/8"x9-3/4")
Net weight	1.5 kg (3.3 lbs.)

18V **LXT XPT**

Fast Charger, Battery Cartridge, (+) (-) Bit, Z: Battery and Charger are sold separately

DDF489RTJ / Z 13mm (1/2") Cordless Driver Drill

New

18V LXT BL Cordless 13 mm (1/2"), Excellent drilling capacity

Li-ion Ah 6.0 | 5.0 | 3.0 | 1.5



Capacity	Steel: 13 mm (1/2"), Wood (Auger-Bit): 38 mm (1-1/2"), Wood (Self-Feed Bit): 51 mm (2"), Wood (Hole Saw): 51 mm (2"), Siding Board: 70 mm (2-3/4")
Chuck capacity	1.5 - 13 mm (1/16 - 1/2")
No Load Speed (RPM)	High/Low: 0 - 1,800 / 0 - 550
Max Fastening Torque	Hard / Soft: 73 / 40 N-m
Max lock torque	80 N-m (700 in.lbs.)
Dimensions (L x W x H)	w/ BL1830B / BL1850B / BL1860B: 174 x 81 x 261 mm
Net weight	1.8 - 2.5 kg (4.0 - 5.5 lbs.)

18V



LXT BL XPT

Belt clip, (+/-) Bit, Battery, Charger, Z: Battery and Charger are sold separately

DDF487RFJ / Z 13mm (1/2") Cordless Driver Drill

18V LXT BL Brushless Cordless 13 mm (1/2") 40 N-m (350 in.lbs.)

Li-ion Ah 6.0 | 5.0 | 3.0 | 1.5



DDF487RFJ
1

Capacity	Steel / Wood (Auger Bit) / Wood (Self-Feed Bit) / Wood (Hole Saw): 13 / 36 / 35 / 51 mm (1/2 / 1-1/16 / 1-3/8 / 2")
Chuck Capacity	1.5 - 13 mm (1/16 - 1/2")
No Load Speed (RPM)	High/Low: 0 - 1,700 / 0 - 500
Max Fastening Torque	Hard / Soft: 40 / 25 N-m
Max Lock Torque	40 N-m (350 in.lbs.)
Dimensions (L x W x H)	w/ BL1830B / BL1850B / BL1860B: 150 x 81 x 248 mm (5-7/8 x 3-1/16 x 9-3/4")
Net weight	1.3 - 1.6 kg (2.9 - 3.5 lbs.)

18V



LXT BL XPT

Belt Clip, (+/-) Bit, Battery, Charger, Z: Battery and Charger are sold separately

DF488D002 / D004 / DYEX4 13mm (1/2") Cordless Driver Drill

18V Li-Ion Cordless 13 mm (1/2") 38 N-m (340 in.lbs.) Driver Drill, G-Battery

Li-ion Ah 2.0 | 1.5



Capacity	Steel: 13 mm (1/2") Wood: 36 mm (1-1/16")
No Load Speed (RPM)	High: 0 - 1,400 Low: 0 - 400
Max Fastening Torque	Hard / Soft: 42 / 24 N-m
Max lock torque	38 N-m (340 in.lbs.)
Dimensions (L x W x H)	221 x 83 x 240 mm (8-3/4 x 3-1/4 x 9-1/2")
Net weight	1.7 kg (3.7 lbs.)

18V



3

G-Series

(+/-) Bit, Battery, Charger

DF332DSAE / DZ 10mm (3/8") Cordless Driver Drill

Extremely Compact and Lightweight

Li-ion Ah 5.0 | 4.0 | 2.0 | 1.5



DF332DSAE
2
DF332DZ
4

Capacity	Steel: 10 mm (3/8") Wood: 28 mm (1-1/8")
Chuck Capacity	0.8 - 10 mm (1/32 - 3/8")
No Load Speed (RPM)	High: 0 - 1,500 Low: 0 - 450
Max Fastening Torque	Hard: 35 N-m Soft: 21 N-m
Max Lock Torque	32 N-m (280 in.lbs.)
Max Output	250W
Dimensions (L x W x H)	154x66x217mm (6-1/16"x2-5/8"x8-1/2")
Net Weight	1 - 1.2 kg (2.3 - 2.6 lbs)

12Vmax



CXT BL XPT

Battery, Charger, Battery cover, Belt clip, Phillips bit, DZ: Battery and Charger are sold separately

DF333DSAE / DZ 10mm (3/8") Cordless Driver Drill

12Vmax CXT Li-Ion Cordless 28 N-m (250 in.lbs.) Driver Drill

Li-ion Ah 5.0 | 4.0 | 2.0 | 1.5



DF333DSAE
2
DF333DZ
4

Capacity	Steel / Wood: 10 / 21 mm (3/8" / 13/16")
Chuck capacity	0.8 - 10 mm (1/32 - 3/8")
No Load Speed (RPM)	High / Low: 0 - 1,700 / 0 - 450
Max Fastening Torque	Hard / Soft: 30 / 14 N-m (270 / 130 in.lbs.)
Max lock torque	28 N-m (250 in.lbs.)
Dimensions (L x W x H)	w/ BL1016/BL1021B: 179x66x212 mm w/ BL1041B: 179x66x229 mm
Net weight	1.1 - 1.2 kg (2.4 - 2.7 lbs.)

12Vmax



CXT

Phillips Bit, Belt Clip, Battery, Charger, DZ: Battery and Charger are sold separately

DF330DWE 10mm (3/8") Cordless Driver Drill

Lightweight and compact but with 2-speed gear selection

Li-ion Ah 1.3



Capacity	Steel: 10 mm (3/8") Wood: 21 mm (13/16")
No Load Speed (RPM)	High: 0 - 1,300 Low: 0 - 350
Max Fastening Torque	Hard / Soft: 24 / 14 N-m
Dimensions (L x W x H)	189x53x183mm (7-7/16"x2-1/16"x7-1/4")
Net Weight	1.0kg (2.2lbs)

10.8V



5

Battery Charger, Battery Cartridge, Phillips Bit, Holster

CORDLESS COMBO KIT

DLX2131JX7

18V LITHIUM-ION



Casing x1
DTD152Z x1
DHP482Z x1
BL1830B x3
DC18RC x1

CLX224SAX1

12Vmax LITHIUM-ION



Aluminium Casing x1
DF333DZ x1
TD110DZ x1
DC10SB x1
BL1021B x2

LCT204

10.8V LITHIUM-ION



Aluminium Casing x1
DC10WA x2
BL1013 x1
DF330DZ x1
TD090DZ x1



DDF083RFE / Z 13mm (1/2") Cordless Driver Drill

Ultra-compact and slim design

Li-ion Ah 6.0 | 5.0 | 3.0 | 1.5



DDF083RFE

2

DDF083Z

6

Capacity	Steel / Wood: 13 / 36 mm (1/2" / 1-7/16")
Chuck capacity	6.35mm (1/4")
No Load Speed (RPM)	High / Low: 0 - 1,700 / 0 - 500
Max Fastening Torque	Hard / Soft: 40 / 23 N-m (350 / 210 in.lbs.)
Max lock torque	40 N-m (350 in.lbs.)
Sound Power Level	77 dB(A)
Dimensions (L x W x H)	124x79x247mm (4-7/8"x3-1/8"x9-3/4")
Net weight	1.1 kg (2.4 lbs)

18V



Belt Clip, Battery, Fast Charger, Phillips bit(DDF083), Z: Battery and Charger are sold separately

DF032DSAE / DZ 10mm (3/8") Cordless Driver Drill

BL motor delivers 35 N-m of max torque

Li-ion Ah 5.0 | 4.0 | 2.0 | 1.5



DF032DSAE

2

DF032DZ

4

Capacity	Steel : 10mm (3/8") Wood : 28mm (1-1/8")
Chuck Capacity	6.35mm (1/4")
No Load Speed (RPM)	High: 0-1,500 Low: 0-450
Max Fastening Torque	Hard: 35 N-m Soft: 21 N-m
Max Lock Torque	32 N-m (280 in.lbs.)
Max Output	250W
Dimensions (L x W x H)	124x66x217mm (4-7/8"x2-5/8"x8-1/2")
Net Weight	0.88 kg (1.9 - 2.3lbs)

12Vmax



Battery, Charger, Battery cover, Belt clip, Phillips bit, DZ: Battery and Charger are sold separately

DF033DZ 10mm (3/8") Cordless Driver Drill

12Vmax CXT Li-Ion Cordless 28 N-m (250 in.lbs.) Driver Drill

Li-ion Ah 5.0 | 4.0 | 2.0 | 1.5



Capacity	Steel / Wood: 10 / 21 mm (3/8" / 13/16")
Chuck capacity	6.35 mm (1/4")
No Load Speed (RPM)	High / Low: 0 - 1,700 / 0 - 450
Max Fastening Torque	Hard / Soft: 30 / 14 N-m (270 / 130 in.lbs.)
Max lock torque	28 N-m (250 in.lbs.)
Dimensions (L x W x H)	w/ BL1016/BL1021B: 149x66x212 mm w/ BL1041B: 149x66x229 mm
Net weight	0.92 - 1.1 kg (2.0 - 2.4 lbs.)

12Vmax



Phillips Bit, Belt Clip, Battery, Charger, DZ: Battery and Charger are sold separately

DF012DSE Cordless Driver Drill

7.2V Li-Ion Cordless 5 mm (3/16") Driver Drill

Li-ion Ah 1.5



Capacity	Steel: 5 mm (3/16") Wood: 6 mm (1/4")
No Load Speed (RPM)	High: 650 Low: 200
Max Fastening Torque	Hard / Soft: 5.6 / 3.6 N-m
Dimensions Straight Type (L x W)	273x44mm (10-3/4"x1-3/4")
Dimensions Pistol Type (L x W x H)	218x44x142mm (8-5/8"x1-3/4"x5-5/8")
Net Weight	0.56 kg (1.21 lbs.)

7.2V



Bit set, Battery, Charger

DF001DW In-Line Cordless Screwdriver

3.6V Li-Ion Cordless Screwdriver, Built-in Battery

Li-ion Ah 1.5



No Load Speed (RPM)	220
Max Fastening Torque	Hard: 4.0 N-m (35 in.lbs.) Soft: 3.0 N-m (27 in.lbs.)
Max Lock Torque	6.0 N-m (53 in.lbs.)
Charging Time (hours)	3 - 5
Dimensions (L x W x H)	Straight Style: 287 x 47 x 51 mm Pistol Style: 205x47x51 mm (8-1/8"x1-7/8"x2")
Net Weight	0.36 kg (0.79 lbs)

3.6V



Bit set, AC Adaptor

DF0300 10mm (3/8") Driver Drill

10 mm (3/8") 320 W Driver Drill with Keyless Chuck

411



Continuous rating input	320W
Capacity	Steel / Wood: 10 / 28mm (3/8" / 1-1/8")
Chuck Capacity	1.0 - 10 mm (1/32 - 3/8")
No Load Speed (RPM)	High / Low: 0 - 1,500 / 0 - 450
Max Fastening Torque	Hard / Soft: 56.0 / 21.0 N-m (500 / 190 in.lbs.)
Max lock torque	42.0 N-m (370 in.lbs.)
Sound Power Level	91 dB(A)
Dimensions (L x W x H)	220x67x206 mm (8-5/8"x2-5/8"x8-1/8")
Net weight	1.2 kg (2.7 lbs.)
Power supply cord	2.5 m (8.2 ft)



Bit

DDA351Z 10mm (3/8") Cordless Angle Drill

18V LXT Li-Ion Cordless 10 mm (3/8") Angle Drill, Keyless Chuck

440

Li-ion Ah 6.0 | 5.0 | 3.0 | 1.5



Capacity	Steel: 10 mm (3/8") Wood: 25 mm (1")
No Load Speed (RPM)	0-1,800
Dimensions (L x W x H)	326x79x115 mm (12-7/8"x3-1/8"x4-1/2")
Net Weight	1.6 - 1.9 kg (4.2 - 3.5 lbs.)

18V



Charger, Battery, Side Grip, Z: Battery and Charger are sold separately

DA333DSE / DZ 10mm (3/8") Cordless Angle Drill

12Vmax CXT Li-Ion Cordless 10 mm (3/8") Angle Drill, Keyless Chuck

Li-ion Ah 5.0 4.0 2.0 1.5



Capacity	Steel: 10 mm (3/8") Wood: 12 mm (1/2")
No Load Speed (RPM)	0 - 1,100
Head Height	84 mm (3-5/16")
Center Height	23.5 mm (15/16")
Dimensions (L x W x H)	313x68x95 mm (12-3/8"x2-11/16"x3-3/4")
Net Weight	1.2 - 1.4 kg (2.7 - 3.0 lbs)



12Vmax



Bit, Belt Clip, Battery, Charger, DZ: Battery and Charger are sold separately

DA3010F 10mm (3/8") Angle Drill

Compact and light body weighs only 1.4kg (3.1lbs)

419



Continuous Rating Input	450W
Capacity	Steel: 10 mm (3/8") Wood: 25 mm (1")
No Load Speed (RPM)	0-2,400
Overall Length	270 mm (10-5/8")
Net Weight	1.6kg (3.5lbs)
Power Supply Cord	2.5m (8.2ft)



Chuck Key 510, Grip 36 Complete

6412 10mm (3/8") Drill

Compact and lightweight, yet with enough power

64

110V

6412/B



Continuous Rating Input	450W
Capacity	Steel: 10 mm (3/8") Wood: 25 mm (1")
No Load Speed (RPM)	0 - 3,400
Dimensions (L x W x H)	228x64x183mm (9"x2-1/2"x7-1/4")
Net Weight	1.3kg (2.9lbs)
Power Supply Cord	2.0m (6.6ft)



Chuck Key

6413 10mm (3/8") Drill

Compact and lightweight, yet with enough power

64



Continuous Rating Input	450W
Capacity	Steel: 10 mm (3/8") Wood: 25 mm (1")
No Load Speed (RPM)	0-3,400
Dimensions (L x W x H)	234x64x183mm (9-1/4"x2-1/2"x7-1/4")
Net Weight	1.3kg (2.9lbs)
Power Supply Cord	2.0m (6.6ft)



6305 13mm (1/2") Drill

13 mm (1/2") 850 W Drill with Keyed Chuck

303



Continuous rating input	850W
Capacity	Steel: 13 mm (1/2") Wood: 30 mm (1-3/16")
No Load Speed (RPM)	1,450
Dimensions (L x W x H)	346x84x152 mm (13-5/8"x3-5/16"x6")
Net weight	2.8 kg (6.2 lbs.)
Power supply cord	2.5 m (8.2 ft)



Chuck Key, Depth Gauge, Side Grip

DP4002/B 13mm (1/2") Drill

Lightweight aluminum gear housing for durability

419



Continuous rating input	750W
Capacity	Steel: 13 mm (1/2") Wood: 38 mm (1-1/2")
No Load Speed (RPM)	0-700
Overall Length	304 mm (12")
Net weight	2.7 kg (5.8 lbs.)
Power supply cord	2.5 m (8.2 ft)



DP4700 13mm (1/2") Drill

Heavy-duty performance drill for professionals

64



Continuous Rating Input	510W
Capacity	Steel: 13 mm (1/2") Wood: 36 mm (1-3/8")
No Load Speed (RPM)	0-550
Overall Length	275 mm (10-7/8")
Net Weight	2.2kg (4.8lbs)
Power Supply Cord	2.5m (8.2ft)



Chuck Key, Side Grip

DS4011 13mm (1/2") Drill

New aesthetic design

411



Continuous Rating Input	750W
Capacity	Steel: 13 mm (1/2") Wood: 36 mm (1-7/16")
No Load Speed (RPM)	600
Dimensions (L x W x H)	340x83x401mm (13-3/8"x3-1/4"x15-3/4")
Net Weight	2.8kg (6.3lbs)
Power Supply Cord	2.5m (8.2ft)



Chuck Key, Side Grip

HAMMER DRILL

Steel, Wood & Masonry

PRODUCTS



HP001GM201(RM2J) / GD201(RD2J) / GZ 13mm (1/2") Cordless Hammer Driver Drill

Delivers 35% or more higher speed than previous model

Li-ion Ah 8.0 5.0 4.0 2.5 2.0



Capacity	Steel: 20 mm (13/16") Wood (Auger-Bit): 50 mm (2") Wood (Self-Feed Bit): 76 mm (3") Wood (Hole Saw): 152 mm (6") Masonry: 20 mm (13/16")
Chuck Capacity	1.5 - 13 mm (1/16 - 1/2")
Impacts Per Minute (IPM)	High/Low: 0 - 39,000 / 0 - 9,750
No Load Speed (RPM)	High/Low: 0 - 2,600 / 0 - 650
Max Fastening Torque	Hard/Soft: 140 / 68 N·m
Max lock torque	125 N·m (1,100 in.lbs.)
Dimensions (L x W x H)	w/BL402S: 182x86x275 mm w/BL4040: 182x86x282 mm
Net weight	2.7 - 3.0 kg (6.0 - 6.6 lbs.)

40Vmax **LXT BL AFT XPT**

Depth Gauge, Side Handle, Belt Clip, (+/-) Bit, Bit Holder, Charger, Battery, Z: Battery and Charger are sold separately

HP002GD201(RD2J) / GA201(SA2J) / GZ 13mm (1/2") Cordless Hammer Driver Drill

Compact and ergonomic design at only 180 mm (7-1/8") long

Li-ion Ah 5.0 4.0 2.5 2.0



Capacity	Steel/Wood/Masonry: 13/38/13 mm (1/2/1-1/2/1/2") 1.5 - 13 mm (1/16 - 1/2")
Chuck Capacity	1.5 - 13 mm (1/16 - 1/2")
Impacts Per Minute (IPM)	High/Low: 0 - 33,000 / 0 - 9,000
No Load Speed (RPM)	High/Low: 0 - 2,200 / 0 - 600
Max Fastening Torque	Hard/Soft: 64/30 N·m (570/270 in.lbs.)
Max lock torque	65 N·m (580 in.lbs.)
Dimensions (L x W x H)	w/BL402S: 180x86x265 mm w/BL4040: 180x86x290 mm
Net weight	2.0 - 2.9 kg (4.4 - 6.4 lbs.)

40Vmax **LXT BL AFT XPT**

Belt Clip, (+/-) Bit, Battery, Charger, Z: Battery and Charger are sold separately

DHP486RTE / Z 13mm (1/2") Cordless Hammer Driver Drill

18V LXT BL Brushless Cordless 13 mm (1/2") 125 N·m (1,100 in.lbs.)

Li-ion Ah 6.0 5.0 3.0 1.5



Capacity	Steel: 13 mm (1/2"), Wood (Auger-Bit): 50 mm (2") Masonry: 16 mm (5/8"), Siding Board: 170 mm (6-11/16")
Chuck capacity	1.5 - 13 mm (1/16 - 1/2")
Impacts Per Minute (IPM)	High/Low: 0 - 31,500 / 0 - 8,250
No Load Speed (RPM)	High/Low: 0 - 2,100 / 0 - 550
Max Fastening Torque	Hard/Soft: 130 / 65 N·m
Max lock torque	125 N·m (1,100 in.lbs.)
Dimensions (L x W x H)	w/BL1830B/BL1850B/BL1860B: 178x81x265 mm
Net weight	2.3 - 2.7 kg (5.1 - 6.0 lbs.)

18V **LXT BL AFT XPT**

Depth Gauge, Side Handle, Belt Clip, (+/-) Bit, Bit Holder, Charger, Battery, Z: Battery and Charger are sold separately

DHP484RTE / RFE / Z 13mm (1/2") Cordless Hammer Driver Drill

Cordless 13 mm (1/2") 60 N·m (530 in.lbs.) Hammer Driver Drill

Li-ion Ah 6.0 5.0 3.0 1.5



Capacity	Steel: 13 mm (1/2") Wood: 38 mm (1-1/2") Masonry: 13 mm (1/2")
Impacts Per Minute (IPM)	High/Low: 0 - 30,000 / 0 - 7,500
No Load Speed (RPM)	High/Low: 0 - 2,000 / 0 - 500
Max Fastening Torque	Hard/Soft: 54 / 30 N·m (480 / 270 in.lbs.)
Max lock torque	60 N·m (530 in.lbs.)
Sound Power Level	99 dB(A)
Dimensions (L x W x H)	182x79x261 mm
Net weight	(7-1/8"x3-1/8"x10-1/4") 1.6 kg (3.5 lbs)

18V **LXT BL AFT XPT**

Fast Charger, Battery Cartridge, (+/-) Bit, Side Grip, Z: Battery and Charger are sold separately

DHP482RTE / RFX1 / RFE / Z 13mm (1/2") Cordless Hammer Driver Drill

Extremely compact tool size

440 mm

Li-ion Ah 6.0 5.0 3.0 1.5

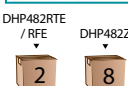

Capacity	Steel: 13 mm (1/2") Wood: 38 mm (1-1/2") Masonry: 13 mm (1/2")
Impacts Per Minute (IPM)	High/Low: 0 - 28,500 / 0 - 9,000
No Load Speed (RPM)	High/Low: 0 - 1,900 / 0 - 600
Max Fastening Torque	Hard/Soft: 62 / 36 N·m (550 / 320 in.lbs.)
Max lock torque	54 N·m (480 in.lbs.)
Dimensions (L x W x H)	198x79x249 mm
Net weight	(7-3/4"x3-1/8"x9-3/4") 1.5 kg (3.4 lbs)

18V **LXT XPT**

Battery, Fast Charger, (+/-) Bit 2-45, Belt clip, Z: Battery and Charger are sold separately

DHP489RTJ / Z 13mm (1/2") Cordless Hammer Driver Drill

New

18V LXT BL Cordless 13 mm (1/2"), Excellent drilling capacity

Li-ion Ah 6.0 5.0 3.0 1.5



Capacity	Steel: 13 mm (1/2"), Wood (Auger-Bit): 38 mm (1-1/2"), Masonry: 16 mm (5/8"), Siding Board: 70 mm (2-3/4")
Chuck capacity	1.5 - 13 mm (1/16 - 1/2")
Impacts Per Minute (IPM)	High/Low: 0 - 27,000 / 0 - 8,250
No Load Speed (RPM)	High/Low: 0 - 1,800 / 0 - 550
Max Fastening Torque	Hard/Soft: 73 / 40 N·m
Max lock torque	80 N·m (700 in.lbs.)
Dimensions (L x W x H)	w/w/BL1830B/BL1850B/BL1860B: 175x81x261 mm
Net weight	1.8 - 2.5 kg (4.0 - 5.5 lbs.)

18V **LXT BL AFT XPT**

Belt clip, (+/-) Bit, Battery, Charger, Z: Battery and Charger are sold separately



DHP487RFJ / Z
13mm (1/2") Cordless Hammer Driver Drill

18V LXT BL Brushless Cordless 13 mm (1/2") 40 N-m (350 in.lbs.)

Li-ion Ah 6.0 5.0 3.0 1.5



DHP487RFJ

5

DHP487Z

6

Capacity	Steel/Wood (Auger Bit) / Wood (Self-Feed Bit) / Wood (Hole Saw) / Masonry: 13 / 36 / 35 / 51 / 13 mm (1/2-1-7/16 / 1-3/8 / 2 / 1-1/2")
Chuck Capacity	1.5 - 13 mm (1/16 - 1/2")
Impacts Per Minute (IPM)	High/Low: 0 - 25,500 / 0 - 7,500
No Load Speed (RPM)	High/Low: 0 - 1,700 / 0 - 500
Max Fastening Torque	Hard / Soft: 40 / 25 N-m
Max Lock Torque	40 N-m (350 in.lbs.)
Dimensions (L x W x H)	w/BL1830B / BL1850B / BL1860B: 164 x 81 x 248 mm
Net weight	1.4 - 1.7 kg (3.1 - 3.7 lbs.)

18V



LXT BL XPT

Belt Clip, (+/-) Bit, Battery, Charger, Z: Battery and Charger are sold separately

DHP453RFX4 / RYE
13mm (1/2") Cordless Hammer Driver Drill

Extremely compact tool size

Li-ion Ah 6.0 5.0 3.0 1.5



Capacity	Steel: 13 mm (1/2") Wood: 36 mm (1-7/16") Masonry: 13 mm (1/2")
Impacts Per Minute (IPM)	High: 0-19,500 Low: 0-6,000
No Load Speed (RPM)	High: 0-1,300 Low: 0-400
Max Fastening Torque	Hard / Soft: 42 / 27 N-m
Max lock torque	38 N-m (340 in.lbs.)
Dimensions (L x W x H)	240x79x244mm (9-7/16"x3-1/8"x9-5/8")
Net weight	1.7kg (3.7lbs)

18V



4

Fast Charger, Battery, (+/-) Bit, Z: Battery and Charger are sold separately

HP332DSAE / DZ 10mm (3/8") Cordless Hammer Driver Drill

Compact and Ergonomic Design at Only 193 mm Long

Li-ion Ah 5.0 4.0 2.0 1.5



Capacity	Steel: 10mm (3/8") Wood: 28mm (1-1/8") Masonry: 8mm (5/16")
Chuck capacity	0.8 - 10 mm (1/32 - 3/8")
Impacts Per Minute (IPM)	High: 0 - 22,500 Low: 0 - 6,750
No Load Speed (RPM)	High: 0 - 1,500 Low: 0 - 450
Max Fastening Torque	Hard: 35 N-m Soft: 21 N-m
Max Lock Torque	32 N-m (280 in.lbs.)
Dimensions (L x W x H)	168x66x217mm (6-5/8"x2-5/8"x8-1/2")
Net Weight	1.1 - 1.3 kg (2.4 - 2.8 lbs)

12Vmax



CXT BL XPT

Battery, Charger, Battery cover, Belt clip, Phillips bit, DZ: Battery and Charger are sold separately

HP333DSAE / DWYE / DYEX4 / DZ
10mm (3/8") Cordless Hammer Driver Drill

12Vmax CXT Li-Ion Cordless 10 mm (3/8") 28 N-m (250 in.lbs.)

Li-ion Ah 5.0 4.0 2.0 1.5



HP333DZ

4

HP333DSAE / DWYE

2

Capacity	Steel / Wood / Masonry: 10 / 21 / 8 mm (3/8" / 13/16" / 5/16")
Impacts Per Minute (IPM)	High / Low: 0 - 25,500 / 0 - 6,750
No Load Speed (RPM)	High / Low: 0 - 1,700 / 0 - 450
Max Fastening Torque	Hard / Soft: 30 / 14 N-m
Max lock torque	28 N-m (250 in.lbs.)
Dimensions (L x W x H)	w/BL1016/BL1021B: 193x66x212 mm w/BL1041B: 193x66x229 mm
Net weight	1.1 - 1.3 kg (2.4 - 2.9 lbs.)

12Vmax



CXT

Phillips Bit, Belt Clip, Battery, Charger, DZ: Battery and Charger are sold separately

HP330DWE 10mm (3/8") Cordless Hammer Driver Drill

Hammer drill mode

Li-ion Ah 1.3



Capacity	Steel: 10 mm (3/8") Wood: 21 mm (13/16") Masonry: 8 mm (5/16")
Impacts Per Minute (IPM)	High: 0-22,500 Low: 0-6,000
No Load Speed (RPM)	High: 0-1,500 Low: 0-400
Max Fastening Torque	Hard / Soft: 24 / 12 N-m
Dimensions (L x W x H)	201x53x183mm (7-7/8"x2-1/16"x7-1/4")
Net Weight	1.1 kg (2.3lbs)

10.8V



2

Charger, Battery Cartridge, Phillips Bit, Holster, DZ: Battery and Charger are sold separately

HP0300 10mm (3/8") Hammer Driver Drill

10 mm (3/8") 320 W Hammer Driver Drill with Keyless Chuck

411



Continuous rating input	320W
Capacity	Concrete / Steel / Wood: 8 / 10 / 28mm (5/16" / 3/8" / 1-1/8")
Chuck Capacity	1.0 - 10 mm (1/32 - 3/8")
No Load Speed (RPM)	High / Low: 0 - 1,500 / 0 - 450
Blows Per Minute (BPM)	High / Low: 0 - 22,500 / 0 - 6,750
Max Fastening Torque	Hard / Soft: 56.0 / 21.0 N-m (500 / 190 in.lbs.)
Max lock torque	42.0 N-m (370 in.lbs.)
Dimensions (L x W x H)	235x67x206 mm (9-1/4"x2-5/8"x8-1/8")
Net weight	1.3 kg (2.8 lbs.)
Power supply cord	2.5 m (8.2 ft)

Bit

6

HP1630 16mm (5/8") Hammer Drill

High power 710W motor

85

110V
HP1630/B



Continuous Rating Input	710W
Capacity	Concrete: 16 mm (5/8") Steel: 13 mm (1/2") Wood: 30 mm (1-3/16")
No Load Speed (RPM)	0 - 3,200
Impacts Per Minute (IPM)	0 - 48,000
Sound Power Level	108 dB(A)
Dimensions (L x W x H)	296x75x204mm (11-5/8"x2-15/16"x8")
Net Weight	2.1 kg (4.6 lbs)
Power Supply Cord	2.0 m (6.6 ft)

Side Grip, Chuck Key (HP1630)

6

HP2050 20mm (3/4") 2-Speed Hammer Drill

Slender and compact body with durable metal gear housing

419



Continuous Rating Input Capacity	720W Concrete: 20 mm (3/4") Steel Hi : 8mm (5/16") Steel Lo : 13mm (1/2") Wood Hi : 25mm (1") Wood Lo : 40mm (1-9/16")
Impacts Per Minute (IPM)	High: 0-58,000 Low: 0-24,000
No Load Speed (RPM)	High: 0-2,900 Low: 0-1,200
Overall Length	362 mm (14-1/4")
Net Weight	2.5kg (5.6lbs)
Power Supply Cord	2.5m (8.2ft)



Chuck Key, Side Grip, Depth Rod

HP2070 20mm (3/4") 2-Speed Hammer Drill

1,010W Power in slender and compact body with durable metal gear housing

419



Continuous Rating Input Capacity	1,010W Concrete: 20 mm (3/4") Steel High : 8mm (5/16") Steel Low : 16mm (5/8") Wood High : 25mm (1") Wood Low: 40mm (1-9/16")
Impacts Per Minute (IPM)	High: 0-58,000 Low: 0-24,000
No Load Speed (RPM)	High: 0-2,900 Low: 0-1,200
Overall Length	364 mm (14-3/8")
Net Weight	2.6kg (5.7lbs)
Power Supply Cord	2.5m (8.2ft)



Chuck Key, Side Grip, Depth Rod

IMPACT DRIVER

PRODUCTS



TD001GM201 (RM2J) / GD201 (RD2J) / GZ
Cordless Impact Driver

High Power 220 N-m

Li-ion Ah 5.0 | 4.0 | 2.5 | 2.0



TD001GM201 / GD201 / GZ



Capacity- Machine screw	M4 - M8 (5/32" - 5/16")
Standard Bolt	M5 - M16 (3/16" - 5/8")
High Strength Bolt	M5 - M14 (3/16" - 9/16")
Coarse thread (in length):	22 - 125 mm (7/8" - 4-7/8")
Hex Shank	6.35 mm (1/4")
No Load Speed (RPM)	0 - 3,700 / 3,200 / 2,100 / 1,100
Impacts Per Minute (IPM)	0 - 4,400 / 3,600 / 2,600 / 1,100
Max Fastening Torque	220 N-m (1,950 in.lbs.)
Fastening Torque	Hard / Med / Soft: 170 / 50 / 20 N-m
Dimensions (L x W x H)	w/ BL4025: 120x86x245 mm w/ BL4040: 120x86x250 mm
Net weight	1.7 - 2.0 kg (3.7 - 4.4 lbs.)

40Vmax



Phillips Bit, Belt Clip, Battery, Charger, Z: Battery and Charger are sold separately

photo: TD002G

Max fastening torque
220 N-m

Dual spring technology

Optimal impact blow suppresses increase in recoil and vibration, which occur after the tool starts impact blow.

- 4-speed power selection
- 6 Assist modes

TD002GZ01 Cordless Impact Driver

New

Cordless Wood/Bolt/T-Mode 220 N-m (1,950 in.lbs.) Impact Driver

Li-ion Ah 8.0 | 5.0 | 4.0 | 2.5 | 2.0



Capacity- Machine screw	M4 - M8 (5/32" - 5/16")
Standard Bolt	M5 - M16 (3/16" - 5/8")
High Strength Bolt	M5 - M14 (3/16" - 9/16")
Coarse thread (in length):	22 - 125 mm (7/8" - 4-7/8")
Hex Shank	6.35 mm (1/4")
No Load Speed (RPM)	0 - 3,700 / 3,200 / 2,100 / 1,100 / 1,800 / 2,700 / 3,700
Impacts Per Minute (IPM)	0 - 4,600 / 3,600 / 2,600 / 1,400 / 4,600 / N/A / 4,600
Max Fastening Torque	220 N-m (1,950 in.lbs.)
Fastening Torque	Hard / Med / Soft: 170 / 50 / 20 N-m
Dimensions (L x W x H)	w/ BL4025: 119x86x247mm w/ BL4050F: 119x86x278mm
Net weight	1.7 - 2.9 kg (3.7 - 6.4 lbs.)

40Vmax



Belt clip, Hand strap (country-specific), Battery, Charger, Z: Battery and Charger are sold separately

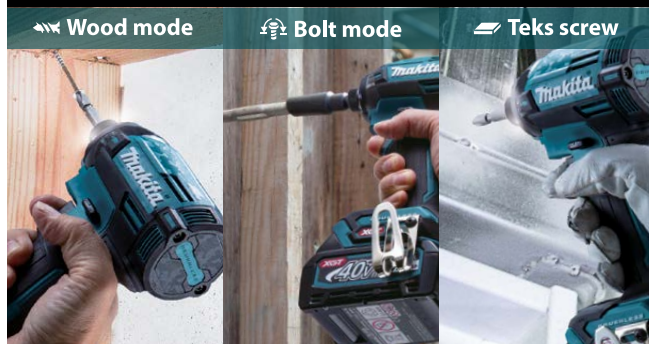

TD003GA201(SA2J) / GZ Cordless Impact Driver

Max fastening torque: 210 N-m

Li-ion Ah 8.0 5.0 4.0 2.5 2.0



Capacity - Machine screw	M4 - M8 (5/32" - 5/16")
Standard Bolt	M5 - M16 (3/16" - 5/8")
High Tensile Bolt	M5 - M14 (3/16" - 9/16")
Coarse thread (in length):	22 - 125 mm (7/8" - 4-7/8")
Hex Shank	6.35 mm (1/4")
No Load Speed (RPM)	0 - 3,700 / 3,200 / 2,100 / 1,100 / 2,400
Impacts Per Minute (IPM)	0 - 4,100 / 3,600 / 2,600 / 1,400 / N/A
Max Fastening Torque	210 N-m (1,860 in.lbs.)
Fastening Torque	Hard / Med / Soft: 170 / 50 / 20 N-m
Dimensions (L x W x H)	w/BL4025: 121x86x245 mm
Net weight	w/BL4050F: 121x86x274 mm 1.7 - 2.9 kg (3.7 - 6.4 lbs.)

40Vmax



Belt clip, Battery, Charger, Z: Battery and Charger are sold separately

DTD172RFJ / RTE / Z Cordless Impact Driver

18V LXT BL Brushless Cordless Wood/Bolt/T-Mode 180 N-m Impact Driver

Li-ion Ah 6.0 5.0 3.0 1.5



Capacity - Machine screw	M4 - M8 (5/32" - 5/16")
Standard Bolt	M5 - M16 (3/16" - 5/8")
High Tensile Bolt	M5 - M14 (3/16" - 9/16")
Coarse thread (in length):	22 - 125 mm (7/8" - 4-7/8")
Hex Shank	6.35 mm (1/4")
No Load Speed (RPM)	0 - 3,600 / 3,200 / 2,100 / 1,100 / 1,800 / 3,600 / 2,900 / 3,600
Impacts Per Minute (IPM)	0 - 3,800 / 3,600 / 2,600 / 1,100 / 3,800 / 3,800 / N/A / 2,600
Max Fastening Torque	180 N-m (1,590 in.lbs.)
Dimension (L x W x H)	114 x 81 x 236 mm
Net weight	1.2 - 1.5 kg (2.7 - 3.5 lbs.)

18V



1



Phillips Bit, Belt Clip, Battery, Charger, Z: Battery and Charger are sold separately

DTD154RTE / Z Cordless Impact Driver

ULTRA-COMPACT and ergonomic design at only 117 mm long

Li-ion Ah 6.0 5.0 3.0 1.5



DTD154RTE
2
DTD154Z
6

Capacity - Machine screw	M4 - M8 (5/32" - 5/16")
Standard Bolt	M5 - M16 (3/16" - 5/8")
High Tensile Bolt	M5 - M14 (3/16" - 9/16")
Coarse thread (in length):	22 - 125 mm (7/8" - 4-7/8")
Hex Shank	6.35 mm (1/4")
No Load Speed (RPM)	0 - 3,600 / 0 - 2,100 / 0 - 1,100
Impacts Per Minute (IPM)	0 - 3,800 / 0 - 2,600 / 0 - 1,100
Max Fastening Torque	175 N-m (1,550 in.lbs.)
Sound Power Level	107 dB(A)
Dimensions (L x W x H)	117 x 79 x 236 mm
Net weight	(4-5/8" x 3-1/8" x 9-1/4") 1.2 kg (2.7 lbs)

18V



Belt clip, Battery, Fast Charger, Z: Battery and Charger are sold separately



DTD153RTE / Z Cordless Impact Driver

High Performance with Brushless DC Motor

Li-ion Ah 6.0 5.0 3.0 1.5



DTD153RTE
2
DTD153Z
3

Capacity - Machine screw	M4 - M8 (5/32" - 5/16")
Standard Bolt	M5 - M16 (3/16" - 5/8")
High Tensile Bolt	M5 - M14 (3/16" - 9/16")
Coarse thread (in length):	22 - 125 mm (7/8" - 4-7/8")
Hex Shank	6.35 mm (1/4")
No Load Speed (RPM)	0 - 3,400
Impacts Per Minute (IPM)	0 - 3,600
Max Fastening Torque	170 N-m (1,500 in.lbs.)
Sound Power Level	107 dB(A)
Dimensions (L x W x H)	126 x 79 x 238 mm
Net weight	(5" x 3-1/8" x 3-3/8") 1.3 kg (2.8 lbs)

18V



Fast Charger, Battery Cartridge, Z: Battery and Charger are sold separately

DTD152RTE / RFE / Z Cordless Impact Driver

Delivers 2,900 max RPM and 165 N-m (1,460 in.lbs.) of max torque

448 Wh

Li-ion Ah 6.0 5.0 3.0 1.5



DTD152RTE / RFE
2
DTD152Z
3

Capacity - Machine screw	M4 - M8 (5/32" - 5/16")
Standard Bolt	M5 - M16 (3/16" - 5/8")
High Tensile Bolt	M5 - M12 (3/16" - 1/2")
Coarse thread (in length):	22 - 125 mm (7/8" - 4-7/8")
Hex Shank	6.35 mm (1/4")
No Load Speed (RPM)	0 - 2,900
Impacts Per Minute (IPM)	0 - 3,500
Max Fastening Torque	165 N-m (1,460 in.lbs.)
Sound Power Level	104 dB(A)
Dimensions (L x W x H)	137 x 79 x 238 mm
Net weight	(5-3/8" x 3-1/8" x 9-3/8") 1.3 kg (2.8 lbs)

18V



Belt clip, Battery, Fast Charger, Z: Battery and Charger are sold separately

DTD156SYE / ZK Cordless Impact Driver

18V LXT Li-Ion Cordless 155 N-m (1,370 in.lbs.) Impact Driver

5 Wh

Li-ion Ah 6.0 5.0 3.0 1.5



DTD156SYE
2

Capacity - Machine screw	M4 - M8 (5/32" - 5/16")
Standard Bolt	M5 - M14 (3/16" - 9/16")
High Tensile Bolt	M5 - M12 (3/16" - 1/2")
Coarse thread (in length):	22 - 125 mm (7/8" - 4-7/8")
Hex Shank	6.35 mm (1/4")
No Load Speed (RPM)	0 - 2,500
Impacts Per Minute (IPM)	0 - 3,000
Max Fastening Torque	155 N-m (1,370 in.lbs.)
Sound Power Level	103 dB(A)
Dimensions (L x W x H)	43 x 79 x 241 mm
Net weight	(5-5/8" x 3-1/8" x 9-1/2") 1.3 - 1.6 kg (2.9 - 3.6 lbs.)

18V



Belt Clip, Battery, Fast Charger Bit, Z: Battery and Charger are sold separately

DTD157RTJ / Z Cordless Impact Driver

Anti-bit wobbling structure

Li-ion Ah 6.0 5.0 3.0 1.5



DTD157RTJ
1
DTD157Z
4

Capacity - Machine screw	M4 - M8 mm (5/32" - 5/16")
Standard Bolt	M5 - M14 (3/16" - 9/16")
High Tensile Bolt	M5 - M12 (3/16" - 1/2")
Coarse thread (in length):	22 - 90 mm (7/8" - 3-1/2")
Hex Shank	6.35 mm (1/4")
No Load Speed (RPM)	Hard/Soft: 0-3,000 / 0-1,300
Impacts Per Minute (IPM)	Hard/Soft: 0-3,900 / 0-1,600
Max Fastening Torque	140 N-m (1,240 in.lbs.)
Dimensions (L x W x H)	133 x 81 x 232 mm
Net weight	(5-1/4" x 3-1/16" x 9-1/8") 1.2 - 1.5 kg (2.7 - 3.3 lbs.)

18V



Belt Clip, Battery, Fast Charger, Z: Battery and Charger are sold separately

TD111DSAE / DZ Cordless Impact Driver Drill

Ultra compact and slim design at only 135 mm (5-5/16") long

Li-ion Ah 5.0 4.0 2.0 1.5



TD111DSAE

2

TD111DZ

4

Capacity- Machine screw	M4 - M8 (5/32" - 5/16")
Standard Bolt	M5 - M14 (3/16" - 9/16")
High Tensile Bolt	M5 - M12 (3/16" - 1/2")
Coarse thread (in length):	22 - 90mm (7/8" - 3-1/2")
Hex Shank	6.35 mm (1/4")
No Load Speed (RPM)	High: 0 - 3,000 Low: 0 - 1,300
Impacts Per Minute (IPM)	High: 0 - 3,900 Low: 0 - 1,600
Max Fastening Torque	135 N-m (1,200 in.lbs.)
Dimensions (L x W x H)	135x66x210mm (5-5/16"x2-5/8"x8-1/4")
Net Weight	0.97 - 1.1kg (2.1 - 2.5lbs)

12Vmax



Battery, Charger, Belt Clip, Phillips Bit, DZ: Battery and Charger are sold separately

TD110DSAE / DWYE / DZ Cordless Impact Driver Drill

12Vmax CXT Li-Ion Cordless 110 N-m (970 in.lbs.) Impact Driver

Li-ion Ah 5.0 4.0 2.0 1.5



TD110DSAE / DWYE

4

TD110DZ

3

Capacity- Machine screw	M4 - M8mm (5/32" - 5/16")
Standard Bolt	M5 - M12 (3/16" - 1/2")
High Tensile Bolt	M5 - M10 (3/16" - 3/8")
Coarse thread (in length):	22 - 90mm (7/8" - 3-1/2")
Hex Shank	6.35 mm (1/4")
No Load Speed (RPM)	0 - 2,600
Impacts Per Minute (IPM)	0 - 3,500
Max Fastening Torque	110 N-m (970 in.lbs.)
Dimensions (L x W x H)	153x66x204mm (6"x2-5/8"x8-1/8")
Net Weight	1 - 1.2kg (2.3 - 2.6 lbs)

12Vmax

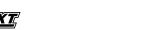

Battery, Charger, Battery cover, Belt clip, Phillips bit, DZ: Battery and Charger are sold separately

TD090DWE Cordless Impact Driver

High operation efficiency with 10.8V Li-ion battery

Li-ion Ah 1.3



Capacity- Machine screw	M4 - M8 (5/32" - 5/16")
Standard Bolt	M5 - M12 (3/16" - 1/2")
High Tensile Bolt	M5 - M10 (3/16" - 3/8")
Coarse thread (in length):	22 - 90mm (7/8" - 3-1/2")
No Load Speed (RPM)	0 - 2,400
Impacts Per Minute (IPM)	0 - 3,000
Max Fastening Torque	90 N-m (800 in.lbs.)
Dimensions (L x W x H)	155x54x178mm (6-1/8"x2-1/8"x7")
Net Weight	0.92kg (2.0lbs)

10.8V



5

Battery Charger, Battery Cartridge, Holster

TD022DSE Cordless Impact Driver

Compact and lightweight for easy handling

Li-ion Ah 1.5



Capacity- Machine screw	M3 - M8 (1/8" - 5/16")
Standard Bolt	M3 - M8 (1/8" - 5/16")
High Tensile Bolt	M3 - M6 (1/8" - 1/4")
Coarse thread (in length):	22 - 45mm (7/8" - 1-3/4")
Hex Shank	6.35 mm (1/4")
No Load Speed (RPM)	0 - 2,450
Impacts Per Minute (IPM)	0 - 3,000
Max Fastening Torque	25 N-m (220 in.lbs.)
Dimensions Straight Type (L x W x H)	282x42x52mm (11-1/8"x1-5/8"x2-1/16")
Dimensions Pistol Type (L x W x H)	227x42x142mm (8-15/16"x1-5/8"x5-5/8")
Net Weight	0.55 - 0.56 kg (1.2 lbs)

7.2V



4

Holster, Bit set, Battery, Charger

DTS141Z Cordless Oil-Pulse Driver

18V LXT BL Brushless Cordless Oil-Pulse Driver

Li-ion Ah 6.0 5.0 3.0 1.5



DTS141RTE

4

Capacity - Machine screw	M4 - M8 (5/32" - 5/16")
Standard Bolt	M5 - M8 (3/16" - 5/16")
High Strength Bolt	M5 - M6 (3/16" - 1/4")
Coarse thread (in length):	22 - 125 mm (7/8" - 4-7/8")
No Load Speed (RPM)	0 - 3,200/0 - 2,000/0 - 1,200
Impacts Per Minute (IPM)	0 - 2,700/0 - 2,200/0 - 1,400
Max Fastening Torque	40 N-m (355 in.lbs.)
Dimensions (L x W x H)	136 x 79 x 240 mm (5-3/8 x 3-1/8 x 9-1/2")
Net weight	1.3 - 1.6 kg (2.8 - 3.5 lbs.)

18V



Charger, Battery, Z: Battery and Charger are sold separately

TD0101F Impact Driver

Compact design for perfect handling

411



Continuous Rating Input	230W
Capacity- Machine screw	M4 - M8 (5/32" - 5/16")
Standard Bolt	M5 - M14 (3/16" - 9/16")
High Tensile Bolt	M5 - M10 (3/16" - 3/8")
Coarse thread (in length):	22 - 90mm (7/8" - 3-1/2")
Driving Shank (Hex)	6.35mm (1/4")
Impacts Per Minute (IPM)	0 - 3,200
No Load Speed (RPM)	0 - 3,600
Max Fastening Torque	100 N-m (74 ft.lbs.)
Dimensions (L x W x H)	184x67x192mm (7-1/4"x2-5/8"x7-9/16")
Net Weight	0.99kg (2.2lbs)
Power Supply Cord	2.5m (8.2ft)



Phillips Bit

DTL061Z Cordless Angle Impact Driver

Compact angle head for easy access in tight places

Li-ion Ah 6.0 5.0 3.0 1.5



Capacity - Machine screw	M4 - M8 (5/32" - 5/16")
Standard Bolt	M4 - M12 (5/32" - 1/2")
High Tensile Bolt	M4 - M8 (5/32" - 5/16")
Coarse thread (in length):	22 - 75 mm (7/8" - 2-31/32")
Hex Shank	6.35 mm (1/4")
No Load Speed (RPM)	0 - 2,000
Impacts Per Minute (IPM)	0 - 3,000
Max Fastening Torque	60 N-m (530 in.lbs.)
Dimensions (L x W x H)	387x78x116 mm (15-1/4"x3-1/16"x4-9/16")
Net weight	1.4 - 2.0 kg (3.1 - 4.3 lbs)

18V



5

Z: Battery and Charger are sold separately

TL064DZ Cordless Angle Impact Driver

12Vmax CXT Li-Ion Cordless 60 N-m (530 in.lbs.) Angle Impact Driver

Li-ion Ah 5.0 4.0 2.0 1.5



Capacity	Machine Screw: M4 - M8 (5/32" - 5/16") Standard Bolt: M4 - M12 (5/32" - 1/2") High Tensile Bolt: M4 - M8 (5/32" - 5/16")
Coarse thread (in length):	22 - 75 mm (7/8" - 2-31/32")
Hex Shank	6.35 mm (1/4")
No Load Speed (RPM)	0 - 2,000
Impacts Per Minute (IPM)	0 - 3,000
Max Fastening Torque	60 N-m (530 in.lbs.)
Dimensions (L x W x H)	361x66x86 mm (14-1/4"x2-5/8"x3-3/8")
Net Weight	1.2 - 1.6 kg (2.7 - 3.6 lbs)

12Vmax



5

Phillips Bit, Belt Clip, Battery, Charger, DZ: Battery and Charger are sold separately

IMPACT WRENCH

PRODUCTS



TW001GM204(RM2JX) / GD203(RD2JX) / GZ 19mm (3/4") Cordless Impact Wrench

Over 2,000 N-m of nut-busting torque

Li-ion Ah 5.0 4.0 2.5 2.0



Fastening Capacities	Standard Bolt: M12 - M36 (1/2" - 1-7/16") High Strength Bolt: M10 - M27 (3/8" - 1-1/16")
Square Drive	19 mm (3/4")
No Load Speed (RPM)	Max / Hard / Med / Soft: 0 - 1,800 / 0 - 1,400 / 0 - 1,150 / 0 - 950
Impacts Per Minute (IPM)	Max / Hard / Med / Soft: 0 - 2,500 / 0 - 2,400 / 0 - 2,200 / 0 - 1,900
Max Fastening Torque	1,800 N-m (1,330 ft.lbs.)
Dimensions (L x W x H)	w/ BL4025: 217x94x297 mm w/ BL4040: 217x94x303 mm
Net weight	3.9 - 4.2 kg (8.6 - 9.3 lbs.)

40Vmax



Belt Clip, Battery, Charger, Z: Battery and Charger are sold separately

TW007GM201(RM2J) / GZ 12.7mm (1/2") Cordless Impact Wrench

Increased torque 730 N-m (540 ft.lbs.)

Li-ion Ah 5.0 4.0 2.5 2.0



Fastening Capacities	Standard Bolt: M10 - M24 (3/8" - 1") High Strength Bolt (Grade 10.9): M10 - M16 (3/8" - 5/8") High Strength Bolt (Grade F10T): M12, M16 (7/16, 5/8")
Square Drive	12.7 mm (1/2")
No Load Speed (RPM)	Max / Hard / Mid / Soft: 0 - 2,300 / 1,900 / 1,200 / 600
Impacts Per Minute (IPM)	Max / Hard / Mid / Soft: 0 - 2,900 / 2,700 / 1,900 / 1,200
Max Fastening Torque	730 N-m (540 ft.lbs.)
Dimensions (L x W x H)	w/ BL4025: 170 x 86 x 285 mm
Net weight	2.7 - 3.3 kg (6.0 - 7.3 lbs.)

40Vmax



Belt Clip, Battery, Charger, Z: Battery and Charger are sold separately

TW004GM202(RM2J) / GD201(RD2J) / GZ 12.7mm (1/2") Cordless Impact Wrench

Increased motor speed under load delivers higher torque

Li-ion Ah 5.0 4.0 2.5 2.0



Fastening Capacities	Standard Bolt: M10 - M20 (3/8" - 3/4") High Strength Bolt: M10 - M16 (3/8" - 5/8")
Square Drive	12.7 mm (1/2")
No Load Speed (RPM)	Max / Hard / Med / Soft: 0 - 3,200 / 2,600 / 1,800 / 1,000
Impacts Per Minute (IPM)	Max / Hard / Med / Soft: 0 - 4,000 / 3,400 / 2,600 / 1,800
Max Fastening Torque	350 N-m (260 ft.lbs.)
Dimensions (L x W x H)	w/ BL4025: 144 x 86 x 248 mm w/ BL4040: 144 x 86 x 253 mm
Net weight	1.9 - 2.2 kg (4.2 - 4.9 lbs.)

40Vmax



Belt Clip, Battery, Charger, Z: Battery and Charger are sold separately

DTW1001JX2 / Z 19mm (3/4") Cordless Impact Wrench

Electronic 3 stage impact power selection reduces fault tightening

Li-ion Ah 6.0 5.0 3.0 1.5



Fastening Capacities	Standard Bolt: M12 - M30 (1/2" - 1-1/4") High Tensile Bolt: M10 - M24 (3/8" - 1")
Square Drive	19 mm (3/4")
No Load Speed (RPM)	Hard / Medium / Soft: 0 - 1,800 / 0 - 1,000 / 0 - 900
Impacts Per Minute (IPM)	Hard / Medium / Soft: 0 - 2,200 / 0 - 2,000 / 0 - 1,800
Max Fastening Torque	1,050 N-m (780 ft.lbs.)
Sound Power Level	109 dB(A)
Dimensions	229x91x289mm (L x W x H) (9"x3-5/8"x11-3/8")
Net weight	3.4kg (7.6lbs)

18V



Fast charger, Battery cartridge (Tool does not come with socket), Z: Battery and Charger are sold separately

DTW1002JX2 / Z 12.7mm (1/2") Cordless Impact Wrench

Most POWERFUL 1,200 N-m (890 ft.lbs.) 1/2" Impact Wrench

Li-ion Ah 6.0 5.0 3.0 1.5



Fastening Capacities	Standard Bolt: M12 - M30 (1/2" - 1-1/4") High Tensile Bolt: M10 - M24 (3/8" - 1")
Square Drive	12.7 mm (1/2")
No Load Speed (RPM)	Hard / Medium / Soft: 0 - 1,800 / 0 - 1,000 / 0 - 900
Impacts Per Minute (IPM)	Hard / Medium / Soft: 0 - 2,200 / 0 - 2,000 / 0 - 1,800
Max Fastening Torque	1,200 N-m (890 ft.lbs.)
Sound Power Level	108 dB(A)
Dimensions	229x91x289mm (L x W x H) (9"x3-5/8"x11-3/8")
Net weight	3.3kg (7.3lbs)

18V



Fast charger, Battery cartridge (Tool does not come with socket), Z: Battery and Charger are sold separately

DTW800RMJ 11.1mm (7/16") Cordless Impact Wrench

Cordless 3-Speed 7/16" (11.2mm) 800 N-m (590 ft.lbs.) Impact Wrench

Li-ion Ah 6.0 5.0 3.0 1.5



Fastening Capacities	Standard Bolt: M12 - M24 (1/2" - 1") High Tensile Bolt: M10 - M22 (3/8" - 7/8")
Hex Shank	11.1 mm (7/16")
No Load Speed (RPM)	Hard / Medium / Soft: 0 - 1,800 / 0 - 1,000 / 0 - 900
Impacts Per Minute (IPM)	Hard / Medium / Soft: 0 - 2,200 / 0 - 2,000 / 0 - 1,800
Max Fastening Torque	800 N-m (590 ft.lbs.)
Sound Power Level	106 dB(A)
Dimensions	229x91x303mm (L x W x H) (9"x3-5/8"x11-7/8")
Net weight	3.4kg (7.6lbs)

18V



Fast charger, Battery cartridge (Tool does not come with socket), Z: Battery and Charger are sold separately

DTW700RTJ / Z 12.7mm (1/2") Cordless Impact Wrench

BL motor delivers 700 N-m (520 ft.lbs.) of max torque

Li-ion Ah 6.0 5.0 3.0 1.5



DTW700RTJ

1

DTW700Z

4

Fastening Capacities	
Standard Bolt:	M10 - M24 (3/8" - 1")
High Strength Bolt:	M10 - M16 (3/8" - 5/8")
Square Drive	12.7 mm (1/2")
No Load Speed (RPM)	Max / Hard / Mid / Soft: 0 - 2,200 / 1,900 / 1,200 / 500
Impacts Per Minute (IPM)	Max / Hard / Mid / Soft: 0 - 2,700 / 2,400 / 1,700 / 1,000
Max Fastening Torque	700 N-m (520 ft.lbs.)
Dimensions (L x W x H)	w/ BL1830B / BL1850B / BL1860B: 170x81x276 mm (6-11/16"x3-3/16"x10-7/8")
Net weight	2.3 - 2.7 kg (5.1 - 6.0 lbs.)

18V



LXT BL XPT

Belt Clip, Battery, Charger, Z: Battery and Charger are sold separately

DTW450RTE / Z 12.7mm (1/2") Cordless Impact Wrench

Maximum fastening torque of 440N.m (3,900in.lbs)

441

Li-ion Ah 6.0 5.0 3.0 1.5



DTW450Z

5

DTW450RTE

1

Fastening Capacities	
Standard Bolt:	M12 - M22 (1/2" - 7/8")
High Tensile Bolt:	M12 - M16 (1/2" - 5/8")
Square Drive	12.7 mm (1/2")
No Load Speed (RPM)	1,600
Impacts Per Minute (IPM)	2,200
Max Fastening Torque	440 N-m (325 ft.lbs.)
Sound Power Level	105 dB(A)
Dimensions	266x82x290mm
(L x W x H)	(10-1/2"x3-1/4"x11-3/8")
Net weight	3.4kg (7.5lbs)

18V



LXT

Fast Charger, Battery Cartridge, Z: Battery and Charger are sold separately (Tool does not come with socket)

DTW300RTJ / RFJ / Z 12.7mm (1/2") Cordless Impact Wrench

BL motor delivers 330 N-m (240 ft.lbs.) of max torque

Li-ion Ah 6.0 5.0 3.0 1.5



DTW300RTJ

1

Fastening Capacities	
Standard Bolt:	M10 - M20 (3/8" - 3/4")
High Strength Bolt:	M10 - M16 (3/8" - 5/8")
Square Drive	12.7 mm (1/2")
No Load Speed (RPM)	Max / Hard / Mid / Soft: 0 - 3,200 / 2,600 / 0 - 1,800 / 0 - 1,000
Impacts Per Minute (IPM)	Max / Hard / Mid / Soft: 0 - 4,000 / 0 - 3,400 / 0 - 2,600 / 0 - 1,800
Max Fastening Torque	330 N-m (240 ft.lbs.)
Dimensions (L x W x H)	w/ BL1830B / BL1850B / BL1860B: 144x81x246 mm (5-5/8"x3-3/16"x9-11/16")
Net weight	1.5 - 1.8 kg (3.4 - 4.1 lbs.)

18V



LXT BL XPT

Belt Clip, Battery, Charger, Z: Battery and Charger are sold separately

DTW251RTE / Z 12.7mm (1/2") Cordless Impact Wrench

High torque to weight ratio at 230N.m (2,040in.lbs)

448

Li-ion Ah 6.0 5.0 3.0 1.5



4

Fastening Capacities	
Standard Bolt:	M10 - M16 (3/8" - 5/8")
High Tensile Bolt:	M10 - M14 (3/8" - 9/16")
Square Drive	12.7 mm (1/2")
No Load Speed (RPM)	0 - 2,100
Impacts Per Minute (IPM)	0 - 3,200
Max Fastening Torque	230 N-m (170 ft.lbs.)
Sound Power Level	105 dB(A)
Dimensions	165x79x234mm
(L x W x H)	(6-1/2"x3-1/8"x9-1/4")
Net weight	1.5kg (3.3lbs)

18V



LXT

Fast Charger, Battery Cartridge, Z: Battery and Charger are sold separately (Tool does not come with socket)

DTW190RFE / Z 12.7mm (1/2") Cordless Impact Wrench

190 N-m (140 ft.lbs.) of Max torque optimal for scaffold building

Li-ion Ah 6.0 5.0 3.0 1.5



2

Fastening Capacities	
Standard Bolt:	M8 - M16 (5/16" - 5/8")
High Tensile Bolt:	M8 - M12 (5/16" - 1/2")
Square Drive	12.7 mm (1/2")
No Load Speed (RPM)	0 - 2,300
Impacts Per Minute (IPM)	0 - 3,000
Max Fastening Torque	190 N-m (140 ft.lbs.)
Sound Power Level	105 dB(A)
Overall Length	176 mm (6-15/16")
Net weight	1.4 kg (3.2 lbs)

18V



LXT

Fast Charger, Battery Cartridge, Z: Battery and Charger are sold separately

TW0200 12.7mm (1/2") Impact Wrench

Aluminum hammer case with high durability (200N.m [150ft.lbs])

411



5

Continuous Rating Input	
Fastening Capacities	380W
Standard Bolt:	M10 - M16 (3/8" - 5/8")
High Tensile Bolt:	M10 - M12 (3/8" - 1/2")
Square Drive	12.7 mm (1/2")
No Load Speed (RPM)	0 - 2,200
Impacts Per Minute (IPM)	0 - 2,200
Max Fastening Torque	200 N-m (150 ft.lbs.)
Sound Power Level	104 dB(A)
Dimensions	251 x 72 x 220mm
(L x W x H)	(9-7/8"x2-13/16"x8-5/8")
Net Weight	2.1kg (4.7lbs)
Power Supply Cord	2.5m (8.2ft)

Socket (24mm)

TW0350 12.7mm (1/2") Impact Wrench

Incredibly high torque of 350N.m (260ft.lbs)

411

110V
TW0350/B

4

Continuous Rating Input	
Fastening Capacities	400W
Standard Bolt:	M12 - M22 (1/2" - 7/8")
High Tensile Bolt:	M12 - M16 (1/2" - 5/8")
Square Drive	12.7 mm (1/2")
No Load Speed (RPM)	2,000
Impacts Per Minute (IPM)	2,000
Max Fastening Torque	350 N-m (260 ft.lbs.)
Sound Power Level	104 dB(A)
Dimensions	283x87x233mm
(L x W x H)	(11-1/8"x3-7/16"x9-1/8")
Net Weight	3.0kg (6.6lbs)
Power Supply Cord	2.5m (8.2ft)



Socket

6906 19mm (3/4") Impact Wrench

Powerful torque of 588N.m(441ft.lbs) for super-duty applications

100



1

Continuous Rating Input	
Capacity	850W
Standard Bolt:	M16 - M22 (5/8" - 7/8")
High Tensile Bolt:	M16 - M20 (5/8" - 3/4")
Square Drive	19 mm (3/4")
No Load Speed (RPM)	1,700
Impacts Per Minute (IPM)	1,600
Max Fastening Torque	588 N-m (441 ft.lbs.)
Sound Power Level	109 dB(A)
Overall Length	327 mm (12-7/8")
Net Weight	5.6kg (12.3lbs)
Power Supply Cord	2.5m (8.2ft)



Side Grip, Socket

TW1000 25.4mm (1") Impact Wrench

Huge 1,000 N-m (738 ft.lbs.) of Power for Industrial Applications



110V
TW1000/B



Continuous Rating Input	1,200W
Fastening Capacities	Standard Bolt: M24-M30(15/16"-1-3/16")
	High Tensile Bolt: M22-M24(7/8"-15/16")
	Square Drive 25.4 mm (1")
No Load Speed (RPM)	1,400
Impacts Per Minute (IPM)	1,500
Max Fastening Torque	1,000 N-m (738 ft.lbs.)
Sound Power Level	114 dB(A)
Dimensions (L x W x H)	382x110x290mm (15"x4-5/16"x11-3/8")
Net Weight	8.8kg (19.4lbs)
Power Supply Cord	2.5m (8.2ft)



Socket 41-80, Side Grip

DWR180RF / Z

9.5mm / 6.35mm (3/8 / 1/4") Cordless Ratchet Wrench

18V LXT Li-Ion Cordless 47.5 N-m (420 in.lbs.) Ratchet Wrench

Li-ion Ah 6.0 | 5.0 | 3.0 | 1.5



Capacity	Standard Bolt: M5 - M12 (3/16 - 1/2")
	High Strength Bolt: M5 - M10 (3/16 - 3/8")
	Square Drive 9.5 / 6.35 mm (3/8 / 1/4")
No Load Speed (RPM)	0 - 800
Max Fastening Torque	47.5 N-m (420 in.lbs.)
Dimensions (L x W x H)	w/ BL1830B / BL1850B / BL1860B: 369 x 79 x 87 mm (14-1/2 x 3-1/8 x 3-7/16")
Net weight	1.2 - 1.6 kg (2.6 - 3.5 lbs.)

18V



6

Socket Adapter, Battery, Charger, Tool Bag, Z: Battery and Charger are sold separately

WR100DSAOK / DZ

9.5mm / 6.35mm (3/8 / 1/4") Cordless Ratchet Wrench

Compatible with variable sockets with socket adapter

Li-ion Ah 5.0 | 4.0 | 2.0 | 1.5



WR100DSAOK



Capacity	Standard Bolt: M5 - M12 (3/16" - 1/2")
	High Tensile Bolt: M5 - M10 (3/16" - 3/8")
	Square Drive 9.5 / 6.35 mm (3/8" / 1/4")
No Load Speed (RPM)	0 - 800
Max Fastening Torque	47.5 N-m (420 in.lbs.)
Dimensions (L x W x H)	w/ BL1016/BL1021B: 341x67x63 mm (13-7/16"x2-5/8"x2-1/2") w/ BL1041B: 341x67x84 mm (13-7/16"x2-5/8"x3-5/16")
Net weight	1.0 - 1.2 kg (2.3 - 2.7 lbs.)

12Vmax



Socket Adapter, Battery, Charger, Tool Bag, DZ: Battery and Charger are sold separately

DTL063Z 9.5mm (3/8") Cordless Angle Impact Wrench

Compact angle head for easy access to bolts in tight places

Li-ion Ah 6.0 | 5.0 | 3.0 | 1.5



Fastening Capacities	Standard Bolt: M4 - M12 (5/32" - 1/2")
	High Tensile Bolt: M4 - M8 (5/32" - 5/16")
	Square Drive 9.5 mm (3/8")
No Load Speed (RPM)	0 - 2,000
Impacts Per Minute (IPM)	0 - 3,000
Max Fastening Torque	60 N-m
Sound Power Level	99 dB(A)
Dimensions (L x W x H)	387x78x116 mm (15-1/4"x3-1/16"x4-9/16")
Net weight	1.4 - 2.0 kg (3.1 - 4.3 lbs.)

18V



5

Z: Battery and Charger are sold separately

Lightweight design



XPT

Higher maneuverability

photo: WT001G

Max. Torque shear bolt capacity
M22

- High strength torque shear bolt (HTB): **M16, M20, M22**
- Super high strength torque shear bolt (SHTB): **M16, M20**
- A325 Torque shear bolt: **5/8, 3/4, 7/8"**
- A490 Torque shear bolt: **5/8, 3/4"**

Battery capacity warning lamp



BL MOTOR
High power with BL motor

WT001G

* **5.5 kg**
battery: BL4040
* Without Sleeve



Predecessor Model
* **7.1 kg**
battery: BL1860Bx2

Hook designed for use with shoulder belt to carry the tool
Shoulder belt (for transportation)



Hook



Bolt-tip ejection lever

enables easy ejection of removed bolt-tip left in the socket of the machine.



Large work amount

Fastening capacity of M22 Torque shear bolt: Battery: BL4025 **Approx. 150 pcs**
Battery: BL4040 **Approx. 250 pcs**

WT001GZ Cordless Shear Wrench

New

40Vmax XGT BL Brushless Cordless 804 N-m (593 ft.lbs.) Shear Wrench

Li-ion Ah 8.0 | 5.0 | 4.0 | 2.5 | 2.0



Capacity	High strength torque shear bolt (HTB): M16, M20, M22 (5/8, 3/4, 7/8")
No Load Speed (RPM)	17 min ⁻¹
Max Fastening Torque	804 N-m (593 ft.lbs.)
Sound Power Level	82 dB(A)
Dimensions (L x W x H)	w/ M22 Sleeve, w/ BL4040: 270 x 95 x 340 mm (10-5/8 x 3-3/4 x 13-3/8")
Net weight	5.2 - 5.9 kg (11.5 - 13 lbs.)

40Vmax



Screwdriver, Shoulder belt, Outer sleeve, Inner sleeve, Battery, Charger, Z: Battery and Charger are sold separately

DWT310ZK Cordless Shear Wrench

High-speed fastening beyond AC tool

Li-ion Ah 6.0 | 5.0 | 3.0 | 1.5



Capacity	Bolt: M16, M20, M22 (5/8", 3/4", 7/8")
No Load Speed (RPM)	14
Max Fastening Torque	804 N-m (593 ft.lbs.)
Sound Power Level	94 dB(A)
Dimensions (L x W x H)	296x130x377 mm (11-5/8"x5-1/8"x14-7/8")
Net weight	6.5 - 7.1 kg (14.3 - 15.7 lbs.)

18V x2



1

Screwdriver, Battery, Fast Charger, Z: Battery and Charger are sold separately

SCREW-DRIVER

PRODUCTS



FS2500 Screwdriver

Best possible tool body for screwdriving

419



Continuous Rating Input	570W
Capacity	Drywall screw: 5mm (3/16") Self-Drilling Screw: 6mm (1/4")
Driving Shank (Hex)	6.35mm (1/4")
No Load Speed (RPM)	0-2,500
Sound Power Level	94 dB(A)
Dimensions (L x W x H)	280x70x207mm (11"x2-3/4"x8-1/8")
Net Weight	1.5kg (3.3lbs)
Power Supply Cord	2.5m (8.2ft)

Dimensions: for countries providing noise suppressor



Magnetic Socket Bit

FS2700 Screwdriver

6 Stage torque adjustment for a wide range of applications

419



Continuous Rating Input	570W
Capacity	Machine screw: 8mm (5/16") Wood screw: 6.2mm (1/4") Self-Drilling Screw: 6mm (1/4")
Driving Shank (Hex)	6.35mm (1/4")
No Load Speed (RPM)	0-2,500
Sound Power Level	94 dB(A)
Dimensions (L x W x H)	301x70x207mm (11-7/8"x2-3/4"x8-1/8")
Net Weight	1.8kg (4.0lbs)
Power Supply Cord	2.5m (8.2ft)

Dimensions: for countries providing noise suppressor



Phillip Insert Bit



FS4300 Drywall Screwdriver

Silent clutch for quiet operation

419



Continuous Rating Input	570W
Capacity	Drywall screw: 5mm (3/16") Self-Drilling Screw: 6mm (1/4")
Driving Shank (Hex)	6.35mm (1/4")
No Load Speed (RPM)	0-4,000
Sound Power Level	93 dB(A)
Dimensions (L x W x H)	279x65x207mm (11"x2-9/16"x8-1/8")
Net Weight	1.4kg (3.1lbs)
Power Supply Cord	2.5m (8.2ft)

Dimensions: for countries providing noise suppressor and connect bit 60



Phillips Insert Bit (2pcs.), Magnetic Bit Holder

MIXER

PRODUCTS



XGT
40Vmax
Li-ION

Photo: UT001G

Heavy duty operation such as mixing concrete

Maximum Blade Diameter
240 mm

BL MOTOR

Low speed
0-500 min⁻¹

High speed
0-920 min⁻¹

Mechanical 2-speed gearing
+
Variable speed control by dial



UT001GZ Cordless Mixer

40Vmax XGT BL Cordless 240 mm (9-1/2") Variable 2-Speed Mixer

Li-ion Ah 8.0 | 5.0 | 4.0 | 2.5 | 2.0

Blade Diameter	240 mm (9-1/2")
No Load Speed (RPM)	High / Low: 0 - 920 / 0 - 500
Max Output	1,200 W
Dimensions (L x W x H)	w/ Cover S, w/ BL4020 / BL4025 / BL4040: 373 x 458 x 235 mm (14-3/4 x 18 x 9-1/4")
Net Weight	5.7 - 7.0 kg (12.6 - 15.4 lbs.)



40Vmax 1

Mixing blade, Shaft (country-specific), Shaft holder (country-specific), Wrenches (country-specific), Battery, Charger, Z: Battery and Charger are sold separately

DUT130Z Cordless Mixer

Variable 2-Speed Mixer

Li-ion Ah 6.0 | 5.0 | 3.0 | 1.5

Blade Diameter	165 mm (6-1/2")
No Load Speed (RPM)	High / Low: 0 - 1,300 / 0 - 350
Shank Size Of Tool Holder Portion	M12 or M14
Dimensions (L x W x H)	w/ Mixing Blade: 916x89x231 mm (36"x3-1/2"x9-1/8") w/o Mixing Blade: 320x89x231 mm (12-5/8"x3-1/2"x9-1/8")
Net Weight	2.6kg (5.7lbs) 2.5 - 2.8 kg (5.6 - 6.3 lbs.)



18V 1

Mixing Blade, Shaft, Shaft Holder (country-specific), Grip, Front Cover, Wrenches, Battery, Charger, Z: Battery and Charger are sold separately



UT1301 Power Mixer

Ideal for stirring of resin, paints and adhesives at high speeds

106

Continuous Rating Input	700W
Blade Diameter	130 mm (5-1/8")
No Load Speed (RPM)	1,300
Overall Length	820 mm (32-1/4")
Net Weight	3.6 kg (7.9 lbs)
Power Supply Cord	2.5 m (8.2 ft)



3

Mixing Blade, Hex Wrench, Wrench

UT1305 Mixer

850W Heavy duty and high speed mixer

303

110V
UT1305/B

Continuous Rating Input	850W
Blade Diameter	165 mm (6-1/2")
No Load Speed (RPM)	1,300
Shank Size Of Tool	M12
Holder Portion	
Dimensions (L x W x H)	942x87x152mm (37"x3-7/16"x6")
Net Weight	2.6kg (5.7lbs)
Power Supply Cord	2.5m (8.2ft)



1

Wrenches, Side Grip, Mixing Blade, Shaft

STATIONARY DRILL

PRODUCTS



HB500 50mm (2") Magnetic Drill

Heavy duty Magnetic Drill

EIB106C

110V
HB500/B

Capacity	Steel: 50 mm (2")
Chuck Capacity	16mm (5/8")
No Load Speed (RPM)	350 / 650
Magnetic Clamping Force	Minimum 9,300N (950kg)
Dimensions (L x W x H)	290x150x450mm (11-3/8"x5-7/8"x17-3/4")
Net Weight	18.5kg



1

Quick release arbor, Small oil cup assembly and clip, Safety guard, Polyester safety strap, Integral oil feed steady allen keys

HB350 35mm (1-3/8") Magnetic Drill

Compact and lightweight for easy transport

UD00EBD002

Continuous Rating Input	1,050W
Capacity	Steel: 35 mm (1-3/8")
No Load Speed (RPM)	850
Magnetic Clamping Force	8,000 N
Dimensions (L x W x H)	270 x 110 x 330 mm
Net Weight	11.5 kg



1

Small oil cup assembly and clip, Safety guard, Polyester safety strap, Allen keys

TB131 13mm (1/2") Drilling Machine 13mm

Compact drilling machine

Continuous rating input	250W
Capacity	Steel: 13mm (1/2") Wood: 24mm (15/16")
No Load Speed (RPM)	570, 890, 1,300, 1,900, 2,670 (50Hz), 690, 1,070, 1,560, 2,280, 3,200 (60Hz)
Net weight	20kg (44lbs)
Power supply cord	1.75m (5.7ft)



1

Chuck Key, Wrench



ROTARY HAMMER

PRODUCTS



HR006GZ(K) 52mm (2-1/16") Cordless Rotary Hammer

Powerful BL motor delivers 20 J of impact energy

Li-ion Ah 8.0 | 5.0 | 4.0 | 2.5 | 2.0



Impact Energy	EPTA-Procedure 05/2009: 21.4 J
Capacity	Concrete (w/ TCT Bit): 52 mm
Blows Per Minute (BPM)	1,100 - 2,250
No Load Speed (RPM)	150 - 310
Max Output	2,600 W
Dimensions (L x W x H)	w/ BL4040: 610 x 140 x 337 mm (24 x 5-1/2 x 13-1/4")
Net weight	12.9 - 14.3 kg (28.4 - 31.5 lbs.)

40Vmax x2



Side Handle, Side Grip, Depth Gauge, Grease vessel, Z: Battery and Charger are sold separately

HR005GM201(RM2K) / GZ(K) 40mm (1-9/16") Cordless Rotary Hammer

8.0 Joules (EPTA) Impact Energy Delivers High Performance

Li-ion Ah 8.0 | 5.0 | 4.0 | 2.5 | 2.0



Impact Energy	EPTA-Procedure 05/2009: 8 J
Capacity	Concrete (w/ TCT Bit): 40 mm
Blows Per Minute (BPM)	1,450 - 2,900
No Load Speed (RPM)	250 - 500
Sound Power Level	102 dB(A)
Vibration Level	Hammer Drilling into Concrete: 5.0 m/s ²
Dimensions (L x W x H)	w/ BL4025: 484 x 115 x 286 mm w/ BL4040: 500 x 115 x 286 mm
Net weight	7.4 - 8.2 kg (16.3 - 18.1 lbs.)

40Vmax



Side Handle, Side Grip, Depth Gauge, Bit Grease, Cloth, Wireless Unit (country-specific), Wireless Unit Adapter (country-specific), Battery, Charger, Z: Battery and Charger are sold separately

HR008GM201(RM2K) / GZ 30mm (1-3/16") Cordless Combination Hammer

New

Cordless 30 mm (1-3/16") Combination Hammer, SDS-PLUS Bits, Quick Change Drill Chuck

Li-ion Ah 8.0 | 5.0 | 4.0 | 2.5 | 2.0



Impact Energy	EPTA-Procedure: 3.9 J
Capacity	Concrete / Steel / Wood / Core Bit / Diamond Core Bit (Dry Type): 30 / 13 / 32 / 80 / 80 mm (1-3/16 / 1/2 / 1-1/4 / 3-1/8 / 3-1/8")
Blows Per Minute (BPM)	0 - 4,500
No Load Speed (RPM)	0 - 840
Chuck Capacity	1.5 - 13 mm (1/16 - 1/2")
Dimensions (L x W x H)	w/ BL4040: 422 x 103 x 242 mm (16-5/8 x 4-1/16 x 9-1/2")
Net weight	5.2 - 6.2 kg (11.5 - 13.7 lbs.)

40Vmax



Side Grip, Depth Gauge, Battery, Charger, Z: Battery and Charger are sold separately

HR009GM201(RM2K) / GZ 30mm (1-3/16") Cordless Combination Hammer

New

Cordless 30 mm (1-3/16") Combination Hammer, SDS-PLUS Bits, Quick Change Drill Chuck

Li-ion Ah 8.0 | 5.0 | 4.0 | 2.5 | 2.0



Impact Energy	EPTA-Procedure: 3.9 J
Capacity	Concrete / Steel / Wood / Core Bit / Diamond Core Bit (Dry Type): 30 / 13 / 32 / 80 / 80 mm (1-3/16 / 1/2 / 1-1/4 / 3-1/8 / 3-1/8")
Blows Per Minute (BPM)	0 - 4,500
No Load Speed (RPM)	0 - 840
Chuck Capacity	1.5 - 13 mm (1/16 - 1/2")
Dimensions (L x W x H)	w/ BL4040: 422 x 103 x 242 mm (16-5/8 x 4-1/16 x 9-1/2")
Net weight	5.2 - 6.2 kg (11.5 - 13.7 lbs.)

40Vmax



Quick Change Drill Chuck, Side Grip, Depth Gauge, Battery, Charger, Z: Battery and Charger are sold separately

Dust Extraction System HEPA filter



HR007G + DX15 (191X39-9)

HR001G
HR003G + DX12 (191E52-3)

HR002G
HR004G + DX14 (191E58-1)

HR008G
HR3011FC + DX10 (191F95-1)

HR009G + DX11 (191G00-4)

HR001GD201(RD2J) / GZ
28mm (1-1/8") Cordless Combination Hammer

Excellent tool balance for easy handling and control

Li-ion Ah 5.0 4.0 2.5 2.0



HR001GD201



HR001GZ



Impact Energy Capacity	EPTA-Procedure 05/2009: 2.8 J Concrete / Steel / Wood / Core Bit / Diamond Core Bit (Dry Type): 28 / 13 / 32 / 54 / 65 mm
Blows Per Minute (BPM)	0 - 5,000
No Load Speed (RPM)	0 - 980
Dimensions (L x W x H)	w/ BL4025: 358x102x232mm (14-1/8"x4"x9-1/8") w/ BL4040: 373x102x238mm (14-3/4"x4"x9-3/8")
Net weight	3.9 - 4.6kg

40Vmax



Side Grip, Depth Gauge, Battery, Charger, Wireless Unit (country-specific), Dust Cup (country-specific), Cleaning cloth (country-specific), Bit Grease (country-specific), Z: Battery and Charger are sold separately

HR002GM201(RM2J) / GZ
28mm (1-1/8") Cordless Combination Hammer

Excellent tool balance for easy handling and control

Li-ion Ah 5.0 4.0 2.5 2.0



HR002GM201

HR002GZ



40Vmax



Side Grip, Depth Gauge, Battery, Charger, Wireless Unit (country-specific), Dust Cup (country-specific), Cleaning cloth (country-specific), Bit Grease (country-specific), Z: Battery and Charger are sold separately

HR003GM201(RM2J) / GZ
28mm (1-1/8") Cordless Combination Hammer

Anti-Vibration Technology (AVT) for extremely low vibration

Li-ion Ah 5.0 4.0 2.5 2.0



HR003GM201



HR003GZ



Impact Energy Capacity	EPTA-Procedure 05/2009: 2.8 J Concrete / Steel / Wood / Core Bit / Diamond Core Bit (Dry Type): 28 / 13 / 32 / 54 / 65 mm
Blows Per Minute (BPM)	0 - 5,000
No Load Speed (RPM)	0 - 980
Dimensions (L x W x H)	w/ BL4025: 358x121x232mm (14-1/8"x4-3/4"x9-1/8") w/ BL4040: 373x102x238mm (14-3/4"x4"x9-3/8")
Net weight	3.9 - 4.6kg

40Vmax



Side Grip, Depth Gauge, Battery, Charger, Wireless Unit (country-specific), Dust Cup (country-specific), Cleaning cloth (country-specific), Bit Grease (country-specific), Z: Battery and Charger are sold separately

HR004GM201(RM2J) / GZ
28mm (1-1/8") Cordless Combination Hammer

Anti-Vibration Technology (AVT) for extremely low vibration

Li-ion Ah 5.0 4.0 2.5 2.0



HR004GM201

HR004GZ



40Vmax



Side Grip, Depth Gauge, Battery, Charger, Wireless Unit (country-specific), Dust Cup (country-specific), Cleaning cloth (country-specific), Bit Grease (country-specific), Z: Battery and Charger are sold separately

HR007GM201(RM2J) / GZ
28mm (1-1/8") Cordless Combination Hammer

Cordless 28mm D-handle combination hammer

Li-ion Ah 5.0 4.0 2.5 2.0



Impact Energy Capacity	EPTA-Procedure 05/2009: 3.0 J Concrete / Steel / Wood / Core Bit / Diamond Core Bit (Dry Type): 28 / 13 / 32 / 54 / 65 mm
Blows Per Minute (BPM)	0 - 5,000
No Load Speed (RPM)	0 - 980
Vibration Level	Hammer Drilling into Concrete: 7.5 m/s ² Chiselling Function w/ Side Grip: 8.6 m/s ² Drilling into Metal: 2.8 m/s ²
Dimensions (L x W x H)	w/ BL4040: 473 x 101 x 240 mm (18-5/8 x 4 x 9-1/2")
Net weight	3.8 - 4.8 kg (8.4 - 10.6 lbs.)

40Vmax



Side Grip, Depth Gauge, Battery, Charger, Cloth, Grease vessel, Z: Battery and Charger are sold separately

HR010GD201(RD2J) / GZ
20mm (13/16") Cordless Combination Hammer

New

40Vmax XGT BL AWS AVT Cordless 20 mm (13/16") Combination Hammer, SDS-PLUS

Li-ion Ah 5.0 4.0 2.5 2.0



Impact Energy Capacity	EPTA-Procedure 05/2009: 2.0 J Concrete (w/ TCT bit) / Steel / Wood: 20 mm / 13 mm / 26 mm
Blows Per Minute (BPM)	0 - 5,000
No Load Speed (RPM)	0 - 1,510
Dimensions (L x W x H)	w/ BL4020 / BL4025: 289 x 93 x 217 mm w/ BL4040: 304 x 93 x 223 mm w/ BL4050F: 323 x 93 x 244 mm
Net weight	2.9 - 4.5 kg (6.4 - 9.9 lbs.)

40Vmax



Side grip, Depth gauge, Battery, Charger, Z: Battery and Charger are sold separately

Vibration absorbing housing

Anti-vibration side grip

AVT
Anti-Vibration Technology

Low vibration

HR010G: **10.0 m/s²**

DHR183: **7.5 m/s²**

Measuring point: at Side grip

— Test conditions —

- Downward drilling, Depth: 80mm
- Drill diameter: ø10.0mm
- Concrete compressive strength: 40N/mm² (According to IEC62841-2-6.)

3 operation modes

- ⌚ Rotation
- ⌚⌚ Rotation + Hammering
- ⌚ Hammering



Equipped with **HEPA filter**

DX16
(1911P2-6)





DHR400ZKN 40mm (1-9/16") Cordless Rotary Hammer

High Power similar to AC Tool

Li-ion Ah 6.0 5.0 3.0 1.5



Impact Energy experimental conditions	EPTA-Procedure 05/2009: 8.0 J 11.4 J
Capacity	Concrete (w/T.C. bit): 40 mm Concrete (w/Core bit): 105 mm
Blows Per Minute (BPM)	1,450 - 2,900
No Load Speed (RPM)	250 - 500
Sound Power Level	102 dB(A)
Dimensions (L x W x H)	473x120x285 mm (18-5/8"x4-3/4"x11-1/4")
Net weight	7.3 - 8.1 kg (16.1 - 17.9 lbs)

18V x2



LXT BL AFT
AWS AVT SOFT NOLOAD XPT

Side Handle, Side Grip, Depth Gauge, Bit Grease, Cloth, Wireless Unit, Battery, Fast Charger, Z: Battery and Charger are sold separately

DHR242RTE / Z 24mm (15/16") Cordless Combination Hammer

Efficient Brushless DC motor provides higher productivity

Li-ion Ah 6.0 5.0 3.0 1.5



DHR242RTE / Z

Impact Energy	2 J
Capacity	Concrete: 24 mm (15/16") Steel: 13 mm (1/2") Wood: 27 mm (1-1/16")
Impacts Per Minute (IPM)	0-4,700
No Load Speed (RPM)	0-950
Sound Power Level	101 dB(A)
Dimensions (L x W x H)	328x85x213 mm (12-7/8"x3-3/8"x8-3/8")
Net weight	3.1 - 3.8 kg (6.7 - 8.4 lbs)

18V



LXT BL XPT

Fast Charger, Battery Cartridge, Depth Gauge, Side Grip, Z: Battery and Charger are sold separately (Tool does not come with bit)



DHR242 + DX06 (199561-6)

HEPA filter

Under load

AVT
ANTI VIBRATION TECHNOLOGY

Active dynamic vibration absorber

- ensures operation with extremely low vibration.
- allows tool design with flat body sides for better handling

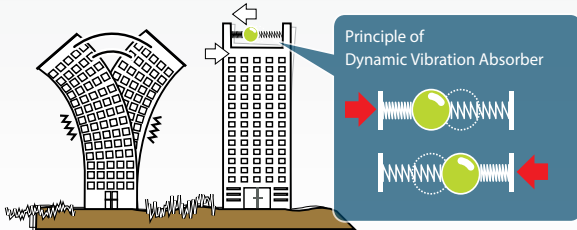
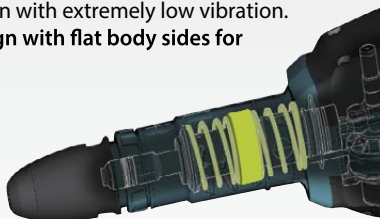

During no-load

SOFT NO LOAD

Suppression of motor speed

- reduces vibration of tool body when idling, accordingly decreases the amount of vibration to operator's hands during a day's operation
- minimizes deflection of bit tip from aiming point when starting chipping

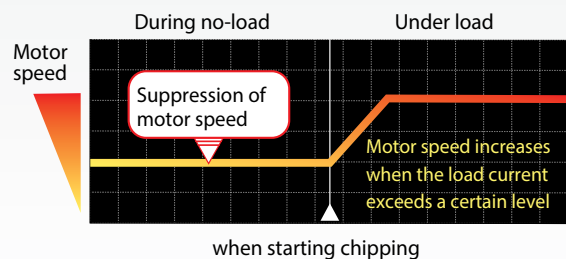

DHR202RTE / Z 20mm (13/16") Cordless Combination Hammer

40 different chisel positions for increased comfort and performance

441

Li-ion Ah 6.0 | 5.0 | 3.0 | 1.5



Capacity	Concrete: 20 mm (13/16") Steel: 13 mm (1/2") Wood: 26 mm (1")
Impacts Per Minute (IPM)	0-4,000
No Load Speed (RPM)	0 - 1,100
Sound Power Level	101 dB(A)
Dimensions (L x W x H)	358 x 84 x 259 mm
Net weight	3.2 - 4 kg (7.1 - 8.8 lbs.)

18V



Charger, Battery, Side Grip, Depth Gauge



HEPA filter



HR010G + DX16 DHR183 (1911P2-6)



DHR183RTWJ / Z 18mm (11/16") Cordless Rotary Hammer

18V LXT BL AVT Cordless 18 mm (11/16") Rotary Hammer, SDS-PLUS, LED light

Li-ion Ah 6.0 | 5.0 | 3.0 | 1.5



Impact Energy	EPTA-Procedure 05/2009: 1.7 J
Capacity	Concrete: 18 mm (11/16") Steel: 13 mm (1/2") Wood: 24 mm (15/16")
Blows Per Minute (BPM)	0 - 5,000
No Load Speed (RPM)	0 - 1,100
Dimensions (L x W x H)	w/ BL1830B / BL1840B / BL1850B / BL1860B: 288 x 89 x 216 mm (11-3/8 x 3-1/2 x 8-1/2")
Net weight	1.9 - 2.9 kg (4.2 - 6.4 lbs.)

18V



Dust cup (country-specific), Side grip, Depth gauge, Battery, Charger, Z: Battery and Charger are sold separately



HR166DSAE1 / DZ 16mm (5/8") Adapted for SDS-PLUS bits

12Vmax CXT BL Brushless Cordless 16 mm (5/8") Rotary Hammer, SDS-PLUS Bits

Li-ion Ah 5.0 | 4.0 | 2.0 | 1.5

HR166DSAE1



Impact Energy	1.1 J
Capacity	Concrete: 16 mm (5/8") Steel: 10 mm (3/8") Wood: 13 mm (1/2")
Blows Per Minute (BPM)	0 - 4,800
No Load Speed (RPM)	0 - 680
Sound Power Level	97 dB(A)
Dimensions (L x W x H)	250x74x187 mm
Net Weight	1.8 - 2.4kg (4.1 - 5.4lbs)

12Vmax



Battery, Charger, DZ: Battery and Charger are sold separately



HR1840J 18mm (11/16") Rotary Hammer

2-Mode operation for "Rotation Only" or "Hammering with Rotation"

459



Continuous Rating Input	470W
Capacity	Our experimental conditions: 1.4 J Concrete (with T.C.T. bit): 18mm (11/16") Steel: 13 mm (1/2") Wood: 24 mm (15/16")
Blows Per Minute (BPM)	0 - 4,800
No Load Speed (RPM)	0 - 1,900
Dimensions (L x W x H)	285x75x208mm (11-1/4"x3"x8-3/16")
Net Weight	2.0 - 2.4 kg (4.3 - 5.3 lbs.)

2 modes



Depth Gauge, Side Grip

HR2020 20mm (3/4") Rotary Hammer

Simple and solid construction, yet powerful performance

419



Continuous Rating Input	710W
Capacity	Concrete: 20 mm (3/4") Steel: 13 mm (1/2") Wood: 32 mm (1-1/4")
Blows Per Minute (BPM)	0 - 4,050
No Load Speed (RPM)	0 - 1,050
Overall Length	352 mm (13-7/8")
Net Weight	2.3 kg (5.1 lbs)
Power Supply Cord	2.5kg (8.2ft)



Depth Gauge, Side Grip

HR2300/B 23mm (7/8") Rotary Hammer

Easy-to-grip handle ergonomically designed to give maximum power thrust

325

110V



Continuous Rating Input	720W
Capacity	Concrete: 23 mm (7/8") Steel: 13 mm (1/2") Wood: 32 mm (1-1/4")
Blows Per Minute (BPM)	0-4,600
No Load Speed (RPM)	0-1,200
Sound Power Level	101 dB(A)
Dimensions (L x W x H)	356x77x209mm (14"x3"x8-1/4")
Net Weight	2.7 - 3.1 kg (5.9 - 6.9lbs)
Power Supply Cord	2.5kg (8.2ft)



Side Grip, Depth Gauge (Tool does not come with bit)

HR2470X5 24mm (15/16") Combination Hammer

High durability in mechanical parts, motor and carbon brush



110V

HR2470X5/B



Continuous Rating Input Capacity	780W Concrete: 24 mm (15/16") Core Bit: 54 mm (2-1/8") Steel: 13 mm (1/2") Wood: 32 mm (1-1/4")
Blows Per Minute (BPM)	0 - 4,500
No Load Speed (RPM)	0 - 1,100
Sound Power Level	101 dB(A)
Dimensions (L x W x H)	370x84x214 mm (14-1/2"x3-5/16"x8-3/8")
Net Weight	2.9 - 3.3kg (6.4 - 7.3lbs)
Power Supply Cord	2.5kg (8.2ft)



Side Handle, Depth Gauge, Quick Change Drill Chuck, SDS-Plus Bit Set (country-specific), Bull Point (country-specific)(HR2470FT), Scaling Chisel (country-specific) (HR2470T)



NEMESIS II

nemesis II drill bit for SDS-PLUS Hammers

Five-star range
★★★★★



Centering tip
Stable and secure drilling

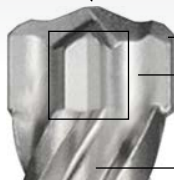

Solid TCT (5 - 10mm)
One piece TCT (11 - 16mm)
Three piece TCT (18 - 32mm)

Wearing mark

Indicator for evaluating the dimensional stability of the anchor holes

Innovated flute geometry

Faster drilling

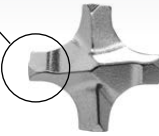

Rebar chamfer

Reduce shock in reinforcement strikes



- *One piece solid carbide tip (5-10mm)
- *No seizing up on hitting reinforcing steel
- *Ensure precision drill holes
- *Drills more precisely
- *Low vibration and high fracture resistance



HR2630X3 26mm (1") Combination Hammer

26mm (1") Combination Hammer



110V

HR2630/B



Continuous Rating Input Capacity	800W Concrete: 26 mm (1") Core Bit: 68 mm (2-11/16") Diamond Core Bit (Dry Type): 80 mm (3-1/8") Steel: 13 mm (1/2") Wood: 32 mm (1-1/4")
Blows Per Minute (BPM)	0 - 4,600
No Load Speed (RPM)	0 - 1,200
Sound Power Level	101 dB(A)
Dimensions (L x W x H)	385x77x209 mm (15-1/8"x3"x8-1/4")
Net Weight	3.0 kg (6.6 lbs)
Power Supply Cord	2.5 m (8.2 ft)



Tool does not come with bit

Side Grip, Depth Gauge

HR2810 28mm (1-1/8") Combination Hammer

3 operation modes - hammering, hammering with rotation, rotation



110V

HR2810/B



Continuous Rating Input Capacity	800W Concrete (with T.C.T. bit): 28mm (1-1/8") Steel: 13 mm (1/2") Wood: 32 mm (1-1/4")
Blows Per Minute (BPM)	0-4,500
No Load Speed (RPM)	0-1,100
Sound Power Level	100 dB(A)
Dimensions (L x W x H)	314x89x225 mm (12-3/8"x3-1/2"x8-7/8")
Net Weight	3.4 - 3.8kg (7.5 - 8.5lbs)
Power Supply Cord	4.0 m (13.1 ft)

Tool does not come with bit



Side Grip, Depth Gauge

HR3001CJ 30mm (1-3/16") Combination Hammer

Drilling efficiency drastically increased by redesigned hammering mechanism



Continuous Rating Input Capacity	1,050W EPTA-Procedure 05/2009: 3.9 J Our experimental conditions: 4.5 J
Capacity	Concrete (w/ TCT Bit): 30 mm (1-3/16") Concrete (w/ Core Bit): 80 mm (3-1/8") Concrete (w/ Diamond Core Bit): 80 mm (3-1/8") Steel: 13 mm (1/2") Wood: 32 mm (1-1/4")
Blows Per Minute (BPM)	0 - 4,500
No Load Speed (RPM)	0 - 840
Dimensions (L x W x H)	369 x 98 x 226 mm
Net Weight	4.1 - 4.5 kg (9.0 - 9.9 lbs.)
Power Supply Cord	4.0 m (13.1 ft)



Depth Gauge, Side Grip

HR3011FCJ 30mm (1-3/16") Combination Hammer

Powerful yet with low vibration due to 2 Counterweights

350



Continuous Rating Input	1,050W
Impact Energy	EPTA-Procedure 05/2009: 3.9 J Our experimental conditions: 4.5 J
Capacity	Concrete (w/ TCT Bit): 30 mm (1-3/16") Concrete (w/ Core Bit): 80 mm (3-1/8") Concrete (w/ Diamond Core Bit): 80 mm (3-1/8") Steel: 13 mm (1/2") Wood: 32 mm (1-1/4")
Blows Per Minute (BPM)	0 - 4,500
No Load Speed (RPM)	0 - 840
Dimensions (L x W x H)	369 x 98 x 242 mm
Net Weight	4.4 - 4.8 kg (9.7 - 10.6 lbs)
Power Supply Cord	4.0 m (13.1 ft)



Depth Gauge, Side Grip

HR3200C 32mm (1-1/4") Combination Hammer

3 operation modes - hammering, hammering with rotation, rotation

350



Continuous Rating Input	850W
Capacity	Concrete (with T.C.T. bit): 32mm (1-1/4") Steel: 13 mm (1/2") Wood: 32 mm (1-1/4")
Blows Per Minute (BPM)	1,650-3,300
No Load Speed (RPM)	315-630
Dimensions	398x108x239 mm (15-5/8"x4-1/4"x9-3/8")
Net Weight	4.8 - 5.2 kg (10.5 - 11.5 lbs)
Power Supply Cord	5.0m (16.4ft)



Depth Gauge, Side Grip, Grease Vessel

HR4002 40mm (1-9/16") Rotary Hammer

High efficiency by high speed

350



HR4002/B



Continuous Rating Input	1,050W
Capacity	Concrete (with T.C.T. bit): 40mm (1-9/16") Concrete (with Core bit): 105mm (4-1/8")
Blows Per Minute (BPM)	2,500
No Load Speed (RPM)	680
Sound Power Level	103 dB(A)
Dimensions	458x114x256mm (18"x4-1/2"x10-1/8")
Net Weight	6.6 - 6.8 kg (14.6 - 15.0 lbs)
Power Supply Cord	5.0m (16.4ft)



Side Grip, Bit Grease, Depth Gauge

HR4003C 40mm (1-9/16") Rotary Hammer

Most powerful and efficient in the class

350



HR4003C/B



Continuous Rating Input	1,100W
Capacity	Concrete (with T.C.T. bit): 40mm (1-9/16") Concrete (with Core bit): 105mm (4-1/8")
Blows Per Minute (BPM)	1,450 - 2,900
No Load Speed (RPM)	250-500
Dimensions	479x106x263mm (18-11/16"x4-3/8"x10-3/8")
Net Weight	6.2 kg (13.8 lbs)
Power Supply Cord	5.0m (16.4ft)



Depth Gauge, Side Handle, Bit Grease

HR4013C 40mm (1-9/16") Rotary Hammer

High efficiency and unrivalled low level of vibration

350



Continuous Rating Input	1,100W
Capacity	Concrete (with T.C.T. bit): 40mm (1-9/16") Concrete (with Core bit): 105mm (4-1/8")
Blows Per Minute (BPM)	1,450 - 2,900
No Load Speed (RPM)	250 - 500
Dimensions	479x112x263mm (18-11/16"x4-3/8"x10-3/8")
Net Weight	6.8 - 6.9 kg (14.9 - 15.3 lbs)
Power Supply Cord	5.0m (16.4ft)

Tool does not come with bit



Depth Gauge, Side Handle, Bit Grease

HR4501C 45mm (1-3/4") Rotary Hammer

High performance and durability

175



Continuous Rating Input	1,350W
Capacity	Concrete (with T.C.T. bit): 45mm (1-3/4") Concrete (with Core bit): 125mm (5")
Blows Per Minute (BPM)	1,250 - 2,750
No Load Speed (RPM)	130 - 280
Dimensions	458x121x288mm (18"x4-3/4"x11-3/8")
Net Weight	8.2 - 8.4 kg (18.1 - 18.5 lbs)
Power Supply Cord	5.0m (16.4ft)

Tool does not come with bit



Side Handle(D), Side Grip, Depth Gauge, Grease Vessel

HR5202C 52mm (2-1/16") Rotary Hammer

High efficiency and durability

175



HR5202C/B



Continuous Rating Input	1,510W
Capacity	Concrete (with T.C.T. bit): 52mm (2") Concrete (with Core bit): 160mm (6-5/16")
Blows Per Minute (BPM)	1,100 - 2,250
No Load Speed (RPM)	150 - 310
Sound Pressure Level	99 dB(A)
Sound Power Level	110 dB(A)
Dimensions	599x134x287mm (23-1/2"x5-1/4"x11-1/4")
Net Weight	10.9 - 11.1 kg (24.1-24.4 lbs)
Power Supply Cord	5.0m (16.4ft)

Tool does not come with bit



Side handle (D), Side grip, Depth gauge, Grease vessel

HR5212C 52mm (2-1/16") Rotary Hammer

High efficiency and unrivalled low level of vibration

175



Continuous Rating Input	1,510W
Capacity	Concrete (with T.C.T. bit): 52mm (2") Concrete (with Core bit): 160mm (6-5/16")
Blows Per Minute (BPM)	1,100 - 2,250
No Load Speed (RPM)	150 - 310
Dimensions	599x140x287mm (23-1/2"x5-1/2"x11-1/4")
Net Weight	11.9-12.0 kg (26.2-26.5 lbs)
Power Supply Cord	5.0m (16.4ft)

Tool does not come with bit



Side Handle (D), Side Grip, Depth Gauge, Grease Vessel

DEMOLITION HAMMER

PRODUCTS



DHK180Z Cordless Power Scraper

18V LXT BL AVT Cordless Power Scraper, SDS-PLUS Bits

Li-ion Ah 6.0 5.0 3.0 1.5



Impact Energy	EPTA-Procedure 05/2009: 3.1 J Our experimental conditions: 3.9 J
Blows Per Minute (BPM)	0 - 3,200
Vibration Level	Chiselling: 4.5 m/s ²
Sound Pressure Level	83 dB(A)
Sound Power Level	94 dB(A)
Dimensions (L x W x H)	368x99x211mm (14-1/2"x3-7/8"x8-5/16")
Net weight	3.3 - 3.6 kg (7.3 - 7.9 lbs.)

18V



LXT BL AVT XPT

1

Bull Point, Cold Chisel (country-specific), Scaling chisel (for tile), Hook, Battery, Charger, Z: Battery and Charger are sold separately

HK1820 Power Scraper

Compact and lightweight. One-touch sliding chuck

350



Continuous Rating Input	550W
Blows Per Minute (BPM)	0-3,200
Dimensions (L x W x H)	351x102x203mm (13-3/4"x4"x8")
Net Weight	3.4kg (7.5lbs)
Power Supply Cord	5.0m (16.4ft)

4

Bull Point, Scaling Chisel, Scaling Chisel (For Tile), Hook Complete

HM002GZ03(K) Cordless Demolition Hammer

40Vmax X2 & BL motor for 20.0 J high power

Li-ion Ah 8.0 5.0 4.0 2.5 2.0



Impact Energy	EPTA-Procedure 05/2009: 20.9 J
Blows Per Minute (BPM)	950 - 1,900
Max Output	2,600W
Shank Diameter	18mm (11/16")
Dimensions (L x W x H)	w/BL4025: 574 x 146 x 324mm (22-5/8 x 5-3/4 x 12-3/4") w/BL4040: 574 x 146 x 324mm (22-5/8 x 5-3/4 x 12-3/4")
Net weight	12.0 - 13.3 kg (26.5 - 29.3 lbs.)

1

40Vmax x2



XGT BL AWS AVT SOFT NOLOAD XPT

Grease for bit, Side Handle, Wireless Unit (country-specific), Wireless Unit Adapter (country-specific), Battery, Charger, Z: Battery and Charger are sold separately

HM001GM204(RM2K) / GZ03(K) Cordless Demolition Hammer

High power and compact

Li-ion Ah 8.0 5.0 4.0 2.5 2.0



Impact Energy	EPTA-Procedure 05/2009: 9.4 J
Blows Per Minute (BPM)	0 - 2,650
Shank Diameter	18mm (11/16")
Sound Power Level	100 dB(A)
Dimensions (L x W x H)	w/BL4025: 481 x 113 x 258mm (19 x 4-7/16 x 10-1/8") w/BL4040: 496 x 113 x 258mm (19-1/2 x 4-7/16 x 10-1/8")
Net weight	6.3 - 7.1 kg (13.9 - 15.7 lbs.)

1

40Vmax



XGT BL AWS AVT SOFT NOLOAD XPT

Bit Grease, Side Grip (country-specific), Wireless Unit (country-specific), Wireless Unit Adapter (country-specific), Cloth, Battery, Charger, Z: Battery and Charger are sold separately



HM0810A 17mm (11/16") Hex Shank Demolition Hammer

Perfect combination of power, durability and compact design

105



Continuous Rating Input	900W
Blows Per Minute (BPM)	2,900
Sound Power Level	103 dB(A)
Overall Length	410 mm (16-1/8")
Net Weight	6.7kg (14.7lbs)
Power Supply Cord	5.0m (16.4ft)

3

Bull Point, Hex Wrench, Side Grip

HM0810TA

17mm (11/16") Hex Shank Demolition Hammer

Perfect combination of power, durability and compact design

105

110V**HM0810TA/B**

Continuous Rating Input	900W
Blows Per Minute (BPM)	2,900
Sound Power Level	103 dB(A)
Overall Length	410 mm (16-1/8")
Net Weight	6.7kg (14.7lbs)
Power Supply Cord	5.0m (16.4ft)



Bull Point, Hex Wrench, Side Grip

HM0870C Demolition Hammer

High durability and excellent demolition performance

350

110V**HM0870C/B**

Continuous Rating Input	1,100W
Blows Per Minute (BPM)	1,100-2,650
Sound Power Level	98 dB(A)
Dimensions (L x W x H)	449x109x230mm (17-3/4"x4-1/4"x9")
Net Weight	5.1-5.3kg (11.1-11.6lbs)
Power Supply Cord	5.0m (16.4ft)

Tool does not come with bull point



Grease for Bit, Side Handle

HM0871C Demolition Hammer

AVT (Anti-Vibration Technology) ensures extra-low vibration performance

350



Continuous Rating Input	1,100W
Blows Per Minute (BPM)	1,100-2,650
Sound Power Level	97 dB(A)
Vibration Level	Chiseling: 8.0 m/s ²
Dimensions (L x W x H)	466x116x230mm (18-3/8"x4-9/16"x9")
Net Weight	5.6-5.8kg (12.4-12.8lbs)
Power Supply Cord	5.0m (16.4ft)

Tool does not come with bull point



Grease for Bit, Side Handle

HM1205C Demolition Hammer

19.1 J Demolition Hammer, SDS-MAX Bits

175



Continuous Rating Input	1,510W
Blows Per Minute (BPM)	950 - 1,900
Dimensions (L x W x H)	576x128x265mm (22-3/4"x5-1/8"x10-3/8")
Net Weight	9.7kg (21.4lbs)
Power Supply Cord	5.0m (16.4ft)



Bull Point, Bit Grease, Side Handle

HM1213C Demolition Hammer

AVT (Anti-Vibration Technology) ensures extra-low vibration performance

175



Continuous Rating Input	1,510W
Blows Per Minute (BPM)	950-1,900
Sound Power Level	95 dB(A)
Dimensions (L x W x H)	576x149x265mm (22-3/4"x5-7/8"x10-3/8")
Net Weight	10.8kg (23.6lbs)
Power Supply Cord	5.0m (16.4ft)



Bull Point, Bit Grease, Side Handle

HM1214C Demolition Hammer

Comfortable operation at hammering downward

175



Continuous Rating Input	1,510W
Blows Per Minute (BPM)	950-1,900
Sound Power Level	98 dB(A)
Dimensions (L x W x H)	700x129x265mm (27-1/2"x5-1/8"x10-3/8")
Net Weight	12.3kg (27.1lbs)
Power Supply Cord	5.0m (16.4ft)

**HM1306** 30mm (1-3/16") Hex Shank Demolition Hammer

21.7 J Demolition Hammer, 30 mm Hex Shank

204

110V**HM1306/B**

Continuous Rating Input	1,510W
Blows Per Minute (BPM)	1,450
Dimensions (L x W x H)	652x121x231mm (25-3/4"x4-3/4"x9-1/8")
Net Weight	15.1kg (33.3lbs)
Power Supply Cord	5.0m (16.4ft)



Bull Point, Wrench, Side Handle, Oil Supply 100ml

HM1501 30mm (1-3/16") Electric Breaker

48.1 J Electric Breaker, 30 mm Hex Shank

218



Continuous rating input	1,850W
Impact Energy	EPTA-Procedure 05/2009: 48.0 J
Blows Per Minute (BPM)	1,300
Dimensions (L x W x H)	781 x 130 x 265 mm (30-3/4 x 5-1/8 x 10-3/8")
Net weight	18.4 kg (40.6 lbs.)
Power supply cord	5.0 m (16.4 ft)



Side Handle

HM1511 30mm (1-3/16") Electric Breaker

48.9 J AVT SOFT NO LOAD Electric Breaker, 30 mm Hex Shank

218



Continuous rating input	1,850W
Impact Energy	EPTA-Procedure 05/2009: 48.0 J
Blows Per Minute (BPM)	1,300
Dimensions (L x W x H)	781 x 130 x 265 mm (30-3/4 x 5-1/8 x 10-3/8")
Net weight	19.2 kg (42.4 lbs.)
Power supply cord	5.0 m (16.4 ft)



Side Handle

HM1812 28.6mm (1-1/8") Electric Breaker

Highest-in-class demolition power with AVT

218



Continuous Rating Input	2,000W
Blows Per Minute (BPM)	870
Sound Power Level	107 dB(A)
Dimensions (L x W x H)	843x210x608mm (33-1/4"x8-1/4"x24")
Net Weight	31.3kg (69.1lbs)
Power Supply Cord	5.0m (16.4ft)



Bull point, Hex wrench

RECIPRO SAW

PRODUCTS



JR002GM201(RM2J) / GD201(RD2J) / GZ 32mm (1-1/4") Cordless Recipro Saw

Compatible with a wide range of cutting applications

Li-ion Ah 8.0 5.0 4.0 2.5 2.0



Length of Stroke	32 mm (1-1/4")
Strokes Per Minute (SPM)	0 - 3,000
Capacity	Pipe: 130 mm (5-1/8") Wood: 255 mm (10") w/ BL4020 / BL4025: 436 x 97 x 250 mm (17-1/8 x 3-13/16 x 9-7/8")
Dimensions (L x W x H)	
Net weight	4.6 - 5.2 kg (10.1 - 11.5 lbs.)



Recipro Saw Blades, Charger, Battery, Z: Battery and Charger are sold separately

JR001GM201(RM2J) / GD201(RD2J) / GZ 32mm (1-1/4") Cordless Recipro Saw

Compact & High Power

Li-ion 5.0 4.0 2.5 2.0



Length of Stroke	32 mm (1-1/4")
Strokes Per Minute (SPM)	High / Low: 0 - 3,000 / 0 - 2,300
Capacity	Pipe: 130 mm (5-1/8") Wood: 255 mm (10") w/ BL4025: 457x88x233 mm (18"x3-1/2"x9-1/8") w/ BL4040: 472x88x239 mm (18-5/8"x3-1/2"x9-3/8")
Dimensions (L x W x H)	
Net weight	4.2 - 4.5 kg (9.3 - 9.9 lbs.)



Recipro Saw Blades, Charger, Battery, Z: Battery and Charger are sold separately

DJR360Z 32mm (1-1/4") Cordless Recipro Saw

Improvement in specifications of cutting speed and stroke length

Li-ion Ah 6.0 5.0 3.0 1.5



Capacity	Pipe: 130mm (5-1/8") Wood: 255mm (10")
Length of stroke	32mm (1-1/4")
Strokes per minute (spm)	High: 0-3,000 Low: 0-2,300
Sound power Level	96 dB(A)
Dimensions (L x W x H)	449x116x243mm (17-3/4"x4-9/16"x9-9/16")
Net weight	4.0kg (8.9lbs)



Fast Charger, Batteries, Recipro saw blades, Z: Battery and Charger are sold separately

DJR187RTE / ZK 32mm (1-1/4") Cordless Recipro Saw

Upgraded model of basic model DJR186 high efficiency by Brushless DC Motor

Li-ion Ah 6.0 5.0 3.0 1.5



Length of Stroke	32 mm (1-1/4")
Strokes Per Minute (SPM)	High / Low: 0 - 3,000 / 0 - 2,300
Capacity	Pipe: 130 mm (5-1/8") Wood: 255 mm (10")
Sound Power Level	95 dB(A)
Dimensions (L x W x H)	439x83x231 mm (17-1/4"x3-1/4"x9-1/8")
Net weight	3.4 - 3.8 kg (7.6 - 8.3 lbs)



Fast Charger, Batteries, Recipro saw blades, Z: Battery and Charger are sold separately

DJR186RTE / ZK 32mm (1-1/4") Cordless Recipro Saw

Higher cutting speed (Max 2,800 SPM)

441

Li-ion Ah 6.0 5.0 3.0 1.5



Length of Stroke	32 mm (1-1/4")
Strokes Per Minute (SPM)	0 - 2,800
Capacity	Pipe: 130 mm (5-1/8") Wood: 255 mm (10")
Sound Power Level	95 dB(A)
Dimensions (L x W x H)	486x81x223 mm (19-1/8"x3-3/16"x8-3/4")
Net weight	3.5 - 3.8 kg (7.6 - 8.3 lbs)

18V



Fast Charger, Batteries, Recipro saw blades, Z: Battery and Charger are sold separately

DJR188RTJ / Z 20mm (13/16") Cordless Recipro Saw

Two switch levers are available with variable speed control

Li-ion Ah 6.0 5.0 3.0 1.5



Length of Stroke	20 mm (13/16")
Strokes Per Minute (SPM)	0 - 3,000
Capacity	Pipe: 130 mm (5-1/8") Wood: 255 mm (10")
Sound Power Level	94 dB(A)
Dimensions (L x W x H)	with BL1815N / BL1820B: 316x81x203 mm (12-1/2"x3-3/16"x8") with BL1830B / BL1840B / BL1850B / BL1860B: 316x81x220 mm (12-1/2"x3-3/16"x8-5/8")
Net weight	2.6 - 2.9 kg (5.7 - 6.4 lbs)

18V



Recipro Saw Blades, Battery, Fast Charger, Z: Battery and Charger are sold separately

DJR189RTJ / Z 22 mm (7/8") Cordless Recipro Saw

Good combination of compact design and high power

Li-ion Ah 6.0 5.0 3.0 1.5



Capacity	Pipe: 130 mm (5-1/8") Wood: 255 mm (10")
Length of stroke	22 mm (7/8")
Strokes Per Minute (SPM)	0-3,100
Dimensions (L x W x H)	410 x 81 x 182 mm (16-1/8 x 3-3/16 x 7-1/8")
Net weight	2.2 - 2.5 kg (4.9 - 5.5 lbs.)

18V



Recipro saw blades, Battery, Charger, Z: Battery and Charger are sold separately

DJR183RTE / Z 13mm (1/2") Cordless Recipro Saw

Two switch levers are available with variable speed control

Li-ion Ah 6.0 5.0 3.0 1.5



Capacity	Pipe: 50 mm (2") Wood: 50 mm (2")
Length of Stroke	13 mm (1/2")
Strokes Per Minute (SPM)	0-3,000
Dimensions (L x W x H)	392x81x209 mm (15-1/2"x3-3/16"x8-1/4")
Net weight	1.5 - 1.7 kg (3.3 - 3.8 lbs)

18V



Fast Charger, Battery Cartridge X2, Recipro Saw Blades, Z: Battery and Charger are sold separately

JR103DWYE 13mm (1/2") Cordless Recipro Saw

Slide style battery and improved ergonomic grip

Li-ion Ah 5.0 4.0 2.0 1.5



Length of Stroke	13mm (1/2")
Strokes Per Minute (SPM)	0 - 3,300
Capacity	Pipe: 50mm (2") Wood: 50mm (2")
Dimensions (L x W x H)	376x66x186mm (14-3/4"x2-5/8"x7-3/8")
Net Weight	1.3 - 1.5kg (2.9 - 3.3lbs)

12Vmax



Battery, Charger, Recipro Saw Blades, Hex Wrench

JR3051TK 30mm (1-3/16") Recipro Saw

1,200 W Recipro Saw

303



Continuous rating input	1,200W
Length of Stroke	30 mm (1-3/16")
Strokes Per Minute (SPM)	0 - 3,000
Capacity	Pipe: 130 mm (5-1/8") Wood: 255 mm (10")
Sound Power Level	99 dB(A)
Dimensions (L x W x H)	447x97x176mm (17-5/8"x3-13/16"x6-15/16")
Net Weight	3.2 - 3.3 kg (7.1 - 7.3 lbs.)
Power supply cord	2.5 m (8.2 ft)



Recipro Saw Blades

JR3061T 32mm (1-1/4") Recipro Saw

1,250 W Recipro Saw

303



Continuous rating input	1,250W
Length of Stroke	32 mm (1-1/4")
Strokes Per Minute (SPM)	0 - 3,000
Capacity	Pipe: 130 mm (5-1/8") Wood: 255 mm (10")
Sound Power Level	99 dB(A)
Dimensions (L x W x H)	487x95x177 mm (19-3/16"x3-3/4"x7")
Net Weight	3.8 kg (8.4 lbs.)
Power supply cord	2.5 m (8.2 ft)



Recipro Saw Blades

JR3070CT 32mm (1-1/4") Recipro Saw

Extra-low vibration and extra power

303



Continuous rating input	1,510W
Length of Stroke	32 mm (1-1/4")
Strokes Per Minute (SPM)	0 - 2,800
Capacity	Pipe: 130 mm (5-1/8") Wood: 255 mm (10")
Sound Power Level	100 dB(A)
Overall Length	485 mm (19-1/8")
Net Weight	4.6 kg (10.0 lbs)
Power supply cord	2.5 m (8.2 ft)



Recipro Saw Blade Set

CUTTING

Masonry & Concrete

PRODUCTS



DCC500RTE / Z 125mm (5") Cordless Cutter

18V LXT BL AWS ADT Cordless 125 mm (5") Cutter, Dry Type

Li-ion Ah 6.0 | 5.0 | 3.0 | 1.5

Blade Diameter	125 mm (5")
Hole Diameter	20 mm (13/16")
Max Cutting Capacity	90°: 40.0 mm (1-9/16") 45°: 27 mm
No Load Speed (RPM)	8,500
Dimensions (L x W x H)	w/ BL1830B / BL1850B / BL1860B: 283 x 158 x 172 mm
Net weight	2.6 - 3.1 kg (5.7 - 6.8 lbs.)



DCC500RTE / Z
1

18V LXT BL AWS ADT XPT

Dust Bag, Hex Wrench, Z: Battery and Charger are sold separately

DMC300RTJ / Z Cordless Compact Cut Off

18V LXT BL AFT Cordless 76 mm (3") Compact Cut Off

Li-ion Ah 6.0 | 5.0 | 3.0 | 1.5

Blade Diameter	76 mm (3")
No Load Speed (RPM)	20,000
Max cutting capacity	w/ Dust cover attachment: 13.5 mm (1/2") w/o Dust cover attachment: 16.0 mm (5/8")
Dimensions (L x W x H)	w/ BL1830B / BL1850B / BL1860B: 271 x 104 x 182 mm (10-5/8 x 4-1/8 x 7-1/8")
Net weight	1.2 - 1.7 kg (2.6 - 3.7 lbs.)



18V LXT BL AFT XPT

Dust Collection Cover, Diamond Wheel, Hex Wrench, Battery, Charger, Z: Battery and Charger are sold separately

76mm (3") cutter suitable for small cutting jobs



Cutting wheel/ thin thickness (Cut-off wheel)
Cutting materials: Steels, Stainless steels



Tungsten carbide grit (Multi carbide wheel)
Cutting materials: Drywalls, plastic boards, Ceramic siding boards



Diamond wheel/ rim
Cutting materials: Tiles

photo: DMC300



Constant speed control

minimizes the reduction in blade speed to provide stable cutting.

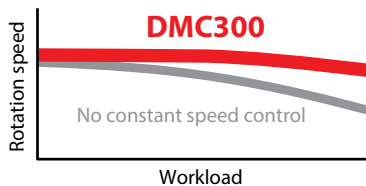

Circumference of grip portion

Reverse switch

enabling to deflect sparks and dust according to working situation



forward rotation **F**

R Reverse

Work amount

on a full battery charge battery: BL1860B

Metal cutting

Cut off M10 steel rods

about **283 pcs**

Wheel used: cut-off wheel

Tile cutting

Cut off 300x5.5mm tiles

about **23 m**

Wheel used: diamond wheel

Max cutting capacity 16mm

No load speed 20,000 min⁻¹

CC301DSYE 85mm (85-3/8") Cordless Cutter

Smooth and powerful cutting at the high rotational speed

Li-ion Ah 5.0 4.0 2.0 1.5



Blade Diameter	85 mm (3-3/8")
Max Cutting Capacity	90°: 25.5 mm (1") 45°: 16.5 mm (5/8")
No Load Speed (RPM)	1,600
Tank Capacity	Water: 0.5 L
Vibration Level	Concrete Cutting: 2.5 m/s ²
Sound Power Level	95 dB(A)
Dimensions (L x W x H)	313x170x125mm (12-3/8"x6-11/16"x4-7/8")
Net Weight	1.9kg (4.1lbs)

12Vmax



Fast Charger, Battery Cartridge, Diamond Wheel, Hex Wrench, Water Supply Tank Ass'y, DZ: Battery and Charger are sold separately

SG1251J 125mm (5") Wall Chaser

Compact design for perfect handling

318



Continuous Rating Input	1,400W
Capacity	Depth: 0-30mm (0 - 1-3/16") Width: 6-30 mm (1/4 - 1-3/16")
Blade Diameter	125 mm (5")
No Load Speed (RPM)	10,000
Dimensions (L x W x H)	350x151x178mm (13-3/4"x5-15/16"x7")
Net Weight	4.3kg (9.5lbs)
Power Supply Cord	5.0m (16.4ft)



Diamond Wheel x 2, Hex Wrench, Lock Nut Wrench

4100NH 110mm (4-3/8") Cutter

More powerful cutting in stone, masonry, tile and concrete

303



Continuous Rating Input	1,300W
Blade Diameter	110 mm (4-3/8")
Max Cutting Capacity	90°: 34 mm (1-3/8")
No Load Speed (RPM)	14,500
Dimensions (L x W x H)	234x210x165 mm (9-1/4"x8-1/4"x6-1/2")
Net Weight	2.9 kg (6.5 lbs)
Power Supply Cord	2.5 m (8.2 ft)

Tool does not come with diamond wheel



Wrench, Socket Wrench (Tool does not come with diamond wheel)

4100NH3Z 110mm (4-3/8") Cutter

Powerful 1,300 W motor delivers 13,800 RPM

303



Continuous Rating Input	1,200W
Blade Diameter	110 mm (4-3/8")
Max Cutting Capacity	90°: 32 mm (1-1/4")
No Load Speed (RPM)	13,800
Dimensions (L x W x H)	227x209x166mm (8-15/16"x8-1/4"x6-1/2")
Net Weight	2.8 kg (6.2 lbs)
Power Supply Cord	2.0 m (6.6 ft)

Tool does not come with diamond wheel. Items of standard equipment and specifications may vary by country or area



Wrench, Hex Wrench

4100KB 125mm (5") Dustless Cutter

125 mm (5") 1,400 W Dustless Cutter, Dry Type

303



Continuous Rating Input	1,400W
Blade Diameter	125 mm (5")
Max Cutting Capacity	40.0 mm (1-9/16")
No Load Speed (RPM)	12,200
Dimensions (L x W x H)	231x220x179 mm (9-1/8"x8-5/8"x7")
Net Weight	3.0 kg (6.6 lbs.)
Power Supply Cord	2.5 m (8.2 ft.)



Diamond Wheel, Dust Bag, Wrench, Hex Wrench

4107R 180mm (7-1/8") Cutter

Quick and clean cutting

153



Continuous Rating Input	1,400W
Capacity	Max cutting: 60mm (2-3/8") 180 mm (7-1/8")
Blade Diameter	180 mm (7-1/8")
No Load Speed (RPM)	5,000
Overall Length	370 mm (14-9/16")
Net Weight	6.3kg (14.5lbs)
Power Supply Cord	5.0m (16.4ft)

Tool does not come with diamond wheel



Socket Wrench, Offset Wrench, Water Plug & Tube

4112HS 305mm (12") Angle Cutter

305m (12") diamond wheel provides max. cutting depth of 100mm (4")

204



Continuous Rating Input	2,400W
Capacity	Max cutting: 100mm (4")
Blade Diameter	305 mm (12")
No Load Speed (RPM)	5,000
Overall Length	648 mm (25-1/2")
Net Weight	10.4kg (22.9lbs)
Power Supply Cord	2.5m (8.2ft)

Tool does not come with diamond wheel



Socket Wrench

4114S 355mm (14") Angle Cutter

High torque delivered at low motor speed of 3,500 rpm

204



Continuous Rating Input	2,400W
Capacity	Max cutting: 125mm (5")
Wheel Diameter	355 mm (14")
Hole Diameter	25.4mm (1")
No Load Speed (RPM)	3,500
Dimensions (L x W x H)	673x240x329mm (26-1/2"x9-1/2"x13")
Net Weight	10.8kg (23.9lbs)
Power Supply Cord	2.5m (8.2ft)

Tool does not come with diamond wheel



Wrench

METAL CUTTING

PRODUCTS



CS002GZ 185mm (7-1/4") Cordless Metal Cutter

Equipped with a Lever for opening/closing Safety cover

Li-ion Ah 8.0 | 5.0 | 4.0 | 2.5 | 2.0



Wheel Diameter	185 mm (7-1/4")
Max Cutting Capacity	67 mm (2-5/8")
No Load Speed (RPM)	3,500
Sound Power Level	113 dB(A)
Dimensions (L x W x H)	350 x 232 x 270 mm (13-3/4 x 9-1/8 x 10-5/8")
Net weight	4.2 - 5.4 kg (9.3 - 11.9 lbs.)

40Vmax



TCT Saw Blade, Hex wrench, Safety goggles (country-specific), Guide rule (country-specific), Battery, Charger, Z: Battery and Charger are sold separately

Cutting speed 20% UP

Max cutting capacity 67 mm

Cutting work amount
Work volume on a single full battery charge
About 140 cuts

Photo: CS002G

DCS553Z 150mm (5-7/8") Cordless Metal Cutter

ADT Cordless Metal Cutter, Electric Brake, Soft Start, Dual LED Lights

Li-ion Ah 6.0 | 5.0 | 3.0 | 1.5



Blade Diameter	150 mm (5-7/8")
Max Cutting Capacity	90°: 57.5 mm (2-1/4")
No Load Speed (RPM)	4,200
Sound Power Level	114 dB(A)
Dimensions (L x W x H)	267 x 186 x 250 mm (10-1/2 x 7-3/8 x 9-7/8")
Net weight	2.8 - 3.1 kg (6.1 - 6.8 lbs.)

18V



TCT Saw Blade, Hex Wrench, Safety Goggles, Guide Rule, Z: Battery and Charger are sold separately

DCS552Z 136mm (5-3/8") Cordless Metal Cutter

Self-Dust Collection Box for Cleaner Work Environment

Li-ion Ah 6.0 | 5.0 | 3.0 | 1.5



Blade Diameter	136 mm (5-3/8")
Max Cutting Capacity	90°: 50.5 mm (2")
No Load Speed (RPM)	3,600
Sound Power Level	113 dB(A)
Dimensions (L x W x H)	348 x 196 x 203 mm (13-3/4 x 7-3/4 x 8")
Net weight	2.4 - 2.7 kg (5.3 - 6.0 lbs.)

18V



TCT Saw Blade, Hex Wrench, Safety Goggles, Z: Battery and Charger are sold separately

DSC251ZK 25mm (1") Cordless Steel Rod Cutter

Ideal for edge cutting of threaded rods and rebars

Li-ion Ah 6.0 | 5.0 | 3.0 | 1.5



Blade Diameter	110 mm (4-5/16")
Cutting Capacity	Dia.: 10 - 25 mm (3/8" - 1")
No Load Speed (RPM)	2,200
Dimensions (L x W x H)	471 x 137 x 139 mm (18-1/2 x 5-25/64 x 5-15/32")
Net weight	4.0 kg (8.8 lbs.)

18V



Tipped Saw, Dust Bag, Side Grip, Hex Wrench, Battery, Charger, Z: Battery and Charger are sold separately

4131 185mm (7-1/4") Metal Cutter

185mm (7-1/4") metal cutter for cutting steel up to 6mm (1/4") in thickness

110V
4131/B



Continuous rating input	1,100W
Blade Diameter	185 mm (7-1/4")
Capacity	Max cutting: 63mm (2-1/2")
No Load Speed (RPM)	3,500
Overall Length	358 mm (14-1/8")
Net Weight	4.8kg (11.3lbs)
Power supply cord	2.5m (8.2ft)



Carbide-Tipped Saw Blade, Hex Wrench, Safety Goggles

LC1230 305mm (12") Metal Cutting Saw

Fast cuts in light pipe, angle iron, tubing, conduit and channels

203

110V
LC1230/B



Continuous rating input	1,750W
Blade Diameter	305 mm (12")
Max Cutting Capacity	90°: 115 mm (4-1/2") 90°: 75 x 150 mm (2-15/16" x 5-7/8") 45°: 90 mm (3-1/2") 45°: 85 x 85 mm (3-5/16" x 3-5/16")
No Load Speed (RPM)	1,300
Dimensions (L x W x H)	516x306x603mm (20-1/4"x12"x23-3/4")
Net Weight	19.3kg (42.5lbs)
Power supply cord	2.5m (8.2ft)

Refer to Cutting Capacity table below



Carbide-Tipped Saw Blade (for mild steel), Socket Wrench, Safety Goggles

PB002GM201(RM2K) / GZ Cordless Portable Band Saw

40Vmax XGT BL Cordless Portable Band Saw

Li-ion Ah 8.0 5.0 4.0 2.5 2.0



Capacity	Square: 127 x 127 mm (5 x 5") 0 - 3.2 m/min (0 - 630 ft/min)
Blade Speed	
Blade Size	Length: 1,140 mm (45") Width: 13 mm (1/2") Thickness: 0.5 mm (0.02")
Dimensions (L x W x H)	510 x 218 x 314 mm (20 x 8-5/8 x 12-3/8")
Net weight	6.5 - 7.1 kg (14.3 - 15.7 lbs.)

40Vmax



Band Saw Blade, Hex Wrench, Battery, Charger, Z: Battery and Charger are sold separately

DPB180Z Cordless Portable Band Saw

Light weight and well balanced tool design

430

Li-ion Ah 6.0 5.0 3.0 1.5



Capacity	Round: 120 mm (4-3/4") Rectangular workpiece without stand: 120x120 mm (4-3/4"x4-3/4")
Blade speed	1.4 - 2.7 m/s (275 - 530 ft/min.)
Dimensions (L x W x H)	523x231x313 mm (20-5/8"x9-1/8"x12-3/8")
Net weight	6.8 - 7.1 kg (14.9 - 15.7 lbs)

18V



Hss Bimetal Band Saw Blade (18 Teeth Per Inch), Hex Wrench, Z: Battery and Charger are sold separately

DPB183Z Cordless Portable Band Saw

18V LXT BL Cordless Portable Band Saw

Li-ion Ah 6.0 5.0 3.0 1.5



Capacity	Round: 66 mm (2-5/8") Square: 66 x 66 mm (2-5/8" x 2-5/8") 0 - 3.2 m/s (0 - 630 ft/min.)
Blade Speed	
Dimensions (L x W x H)	w/ BL1830B / BL1850B / BL1860B: 392x174x242 mm (15-1/2"x6-7/8"x9-1/2")
Net weight	3.6 - 3.9 kg (7.9 - 8.6 lbs.)

18V



Band Saw Blade, Hex Wrench, Hook (country-specific), Grip (country-specific), Battery, Charger, Z: Battery and Charger are sold separately

DPB184Z Cordless Portable Band Saw

Stable cutting with highly rigid aluminium structure

Li-ion Ah 6.0 5.0 3.0 1.5



Capacity	Round: 51 mm (2") Square: 51 x 51 mm (2" x 2")
Blade Speed	0 - 3.2 m/s (0 - 630 ft/min.)
Dimensions (L x W x H)	w/ BL1830B / BL1850B / BL1860B: 373x162x223 mm (14-3/4"x6-3/8"x8-3/4")
Net weight	3.3 - 3.6 kg (7.3 - 7.9 lbs.)

18V



Band Saw Blade, Hex Wrench, Hook (country-specific), Battery, Charger, Z: Battery and Charger are sold separately

DPB182Z Cordless Portable Band Saw

18V LXT Li-Ion Cordless Portable Band Saw

Li-ion Ah 6.0 5.0 3.0 1.5



Capacity	Round: 64 mm (2-1/2") Rectangular: 64x64 mm (2-1/2"x2-1/2")
Blade speed	3.2 m/s (630 ft/min.)
Dimensions (L x W x H)	477x197x229 mm (18-3/4"x7-3/4"x9")
Net weight	3.8 - 4.1 kg (8.3 - 9.0 lbs.)

18V



Band Saw Blade, Wheel Cover (country-specific), Hook (country-specific), Hex Wrench, Battery, Z: Battery and Charger are sold separately

2107FK Portable Band Saw

Large 120 x 120mm (4-3/4" x 4-3/4") capacity with excellent tool balance

303



Continuous rating input	710W
Capacity	Round: 120 mm (4-3/4") Rectangular workpiece Without stand: 120x120mm (4-3/4"x4-3/4")
Blade speed	1.0 - 1.7 m/s (60m (200 ft) - 105m (350 ft) / min)
Dimensions (L x W x H)	508x188x256mm (20"x7-3/8"x10-1/8")
Net Weight	6.3kg (13.9lbs)
Power supply cord	2.5m (8.2ft)



Carbon Steel Band Saw Blade (18 teeth per inch) 1 pc, Hex Wrench

DSC163ZK Cordless Steel Rod Cutter

18V LXT BL Brushless Cordless 16 mm (5/8") Steel Rod Cutter

Li-ion Ah 6.0 5.0 3.0 1.5



Cutting Capacity	Dia: 3 - 16 mm (1/8" - 5/8")
Cutting Speed (sec)	2.8
Dimensions (L x W x H)	360x108x276 mm (14-1/8"x4-1/4"x10-7/8")
Net weight	6.9 kg (15.2 lbs.)

18V



Wrench, Hex Wrench, Oil, Z: Battery and Charger are sold separately

DSC191Z Cordless Steel Rod Cutter

Cutting capacity range of 3 - 20 mm standard rebar



Li-ion Ah 6.0 5.0 3.0 1.5



Cutting Capacity	Dia: 3 - 20 mm (1/8" - 3/4")
Cutting Speed (sec)	6.5
Sound Power Level	90.1 dB(A)
Dimensions (L x W x H)	412x212x284 mm (16-1/5"x8-3/8"x11-1/8")
Net weight	11.1 - 11.2 kg (24.5 - 24.6 lbs.)

18V



Wrench, Hex Wrench, Oil supply, Z: Battery and Charger are sold separately

DPP200ZK Cordless Hole Puncher

18V LXT Li-Ion Cordless Hole Puncher

Li-ion Ah 6.0 5.0 3.0 1.5



Capacity	Steel: 20 mm (13/16") Stainless Steel: 20 mm (13/16")
Max Throat Depth	40 mm (1-9/16")
Dimensions (L x W x H)	417x127x315 mm (16-3/8"x5"x12-3/8")
Net weight	10.5 kg (23.2 lbs.)

18V



Punch, Dice, Hex Wrench, Spanner, Bar for fastening nuts, Grip, Oil, Z: Battery and Charger are sold separately

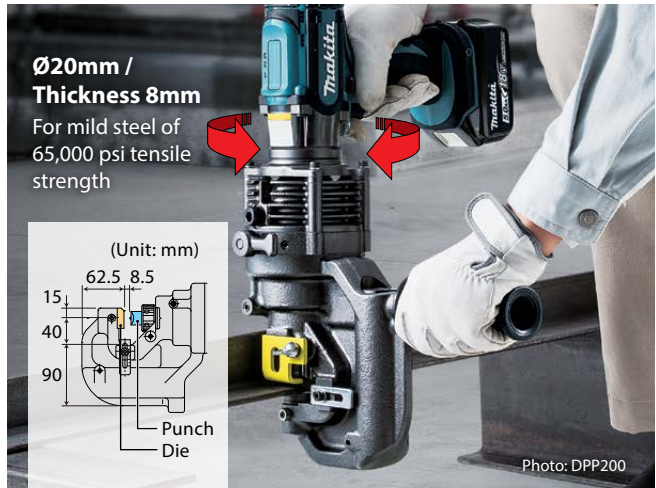

Ø20mm / Thickness 8mm

For mild steel of 65,000 psi tensile strength

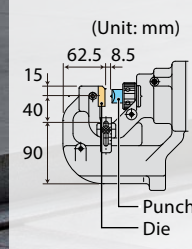
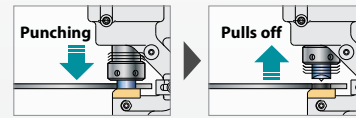

Photo: DPP200



Automatic punch return

After a punching cycle is completed, hydraulic pressure automatically pulls off the punch from workpiece and returns it to the initial position to enable efficient continuous hole punching.

Versatile punch is applicable to a variety of materials: mild steel, stainless steel, channel, aluminum and copper.

Punching capacity



Flat bar	Max: 80mm x t8 (Center punching)
Angle	Min: 40mm x 40mm x t3 Max: 80mm x 80mm x t8
Channel	Min: 75mm x 40mm Max: 100mm x 50mm (Flange punching)

DLW140Z 355mm (14") Portable Cut-off

18V X2 (36V) LXT BL 355 mm (14") Toolless Portable Cut-Off

Li-ion Ah 6.0 5.0 3.0 1.5



Wheel Diameter	355 mm (14")
Hole Diameter	25.4 mm (1")
No Load Speed (RPM)	3,800
Max Output	1,300 W
Sound Power Level	115dB
Dimensions (L x W x H)	537x290x640 mm (21-1/8"x11-3/8"x25-1/4")
Net weight	17.2 - 17.8 kg (37.9 - 39.3 lbs.)

18V x2



Abrasive Cut-Off Wheel, Z: Battery and Charger are sold separately

LW1401 355mm (14") Portable Cut-off

Powerful 2,200W motor 355mm (14") Portable Cut-off, successor to 2414NB



110V
LW1401/B



Continuous rating input	2,200W
Wheel Diameter	355 mm (14")
No Load Speed (RPM)	3,800
Capacity at 90°	Round: 127 mm (5") Rectangular: 102x194 mm (4"x7-5/8")
Sound Power Level	110 dB(A)
Dimensions (L x W x H)	500x295x640mm (19-3/4"x11-5/8"x25-1/4")
Net Weight	18.3 kg (40.3 lbs)
Power supply cord	2.5m (8.2ft)

Refer to Cutting Capacity table below



Abrasive cut-off wheel, Socket wrench

Abrasive cut-off wheel for portable cut-off

For all ferrous materials (Steel, cast iron) and other hard metals

Size (mm)	Grit	Pc. per pkg.	Part No.
355 x 2.5 x 25.4	A36P	5	B-49448-5
355 x 2.5 x 25.4	A36P	25	B-49448-25



Features

1. Thinner



3.0mm

2. Less burred

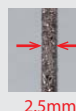

2.5mm



New 2.5mm thickness



Current 3.0mm thickness

Cutting Capacity

Form of materials	Miter angle	
	0°	45°
	D: ø127mm (2")	D: ø127mm (2")
	H x W: 102 x 194mm (4" x 7-5/8") 70 x 233mm (2-3/4" x 9-1/8")	H x W: 115 x 103mm (4-1/2" x 4-1/16")
	H x W: 119 x 119mm (4-11/16" x 4-11/16")	H x W: 106 x 106mm (4-3/16" x 4-3/16")
	S x S: 137 x 137mm, T: 10mm (5-3/8" x 5-3/8", 3/8")	S x S: 100 x 100mm, T: 10mm (4" x 4", 3/8")

D: Diameter W: Width H: Height S: Side T: Thickness

2416S 405mm (16") Portable Cut-off

405mm (16") blade for more cutting capacity

153



Abrasive Cut-Off Wheel, Socket Wrench

Continuous rating input	1,430W
Wheel Diameter	405 mm (16")
Hole Diameter	25.4mm (1")
No Load Speed (RPM)	2,300
Dimensions (L x W x H)	610x265x535mm (24"x10-3/8"x21")
Net Weight	19.2kg (42.3lbs)
Power supply cord	2.5m (8.2ft)

Refer to Cutting Capacity table below

DJS161Z 1.6mm Cordless Straight Shear

High cutting capacity: cuts up to 1.6 mm thick mild steel sheet

430

Li-ion Ah 6.0 5.0 3.0 1.5



Capacity	Steel up to 400 N/mm ² : 1.6 mm Steel up to 600 N/mm ² : 1.2 mm Aluminum up to 200 N/mm ² : 2.5 mm
Strokes Per Minute (SPM)	4,300
Dimensions (L x W x H)	362x78x118 mm (14-1/4"x3-1/16"x4-5/8")
Net weight	1.8 - 2.2 kg (4.1 - 4.8 lbs)

18V

LXT

4

Hex Wrench, Thickness Gauge, Z: Battery and Charger are sold separately

DJS101Z 1.0mm Cordless Metal Shear

Easy curve cutting

430

Li-ion Ah 6.0 5.0 3.0 1.5



Capacity	Steel up to 400 N/mm ² : 1.0 mm Steel up to 600 N/mm ² : 0.7 mm Aluminum up to 200 N/mm ² : 2.5 mm
Strokes Per Minute (SPM)	4,300
Dimensions (L x W x H)	364x78x118 mm (14-3/8"x3-1/16"x4-5/8")
Net weight	1.8 - 2.2 kg (4.0 - 4.7 lbs)

18V

LXT

4

Hex Wrench, Z: Battery and Charger are sold separately

DJS130Z 1.3mm Cordless Metal Shear

Nibbler without cord expands more operating field

440

Li-ion Ah 6.0 5.0 3.0 1.5



Capacity	Steel up to 400 N/mm ² : 1.3 mm Steel up to 600 N/mm ² : 1.0 mm
No Load Speed (RPM)	2,800
Dimensions (L x W x H)	350x80x193 mm (13-3/4"x3-1/8"x7-5/8")
Net weight	2.3 - 2.6 kg (5.0 - 5.8 lbs)

18V

LXT

5

Hex Wrench, Hook, Z: Battery and Charger are sold separately

JS1601 1.6mm (16Ga) Straight Metal Shear

Minimum outside cutting radius of 250 mm (9-7/8")

459



8

Hex Wrench, Thickness Gauge

Continuous rating input	380W
Capacity	Steel up to 400 N/mm ² : 1.6mm Steel up to 600 N/mm ² : 1.2mm Steel up to 800 N/mm ² : 0.8mm Aluminum up to 200 N/mm ² : 2.5mm
Min. cutting radius	250mm (9-7/8")
Strokes Per Minute (SPM)	4,500
Dimensions (L x W x H)	320x70x78mm (12-5/8"x2-3/4"x3-1/16")
Net Weight	1.4kg (3.1lbs)
Power supply cord	2.5m (8.2ft)

JS1300 1.3mm Straight Shear

Low noise level (only 80dB) for quieter operation

419



5

Hex Wrench

Continuous rating input	570W
Capacity	Steel up to 400 N/mm ² : 1.3 mm Steel up to 600 N/mm ² : 1.0 mm Steel up to 800 N/mm ² : 0.5 mm Aluminum up to 200 N/mm ² : 2.5 mm
Strokes Per Minute (SPM)	0-2,500
Overall Length	302 mm (11-7/8")
Net Weight	1.8 kg (3.9 lbs)
Power supply cord	2.5 m (8.2 ft)

JS1602 1.6mm (16Ga) Metal Shear

Cuts 16 Ga. Mild Steel and 18 Ga. Stainless

459



8

Hex Wrench

Continuous rating input	380W
Capacity	Steel up to 400 N/mm ² : 1.6mm Steel up to 600 N/mm ² : 1.2mm Steel up to 800 N/mm ² : 0.8mm Aluminum up to 200 N/mm ² : 2.5mm
Min. cutting radius	30mm (1-3/16")
Strokes Per Minute (SPM)	4,000
Dimensions (L x W x H)	255x74x146mm (10"x2-15/16"x5-3/4")
Net Weight	1.6kg (3.4lbs)
Power supply cord	2.5m (8.2ft)

JS3201J 3.2mm (10Ga) Metal Shear

Robust design with elastomer coated handle provides easy operation

303



1

Shear Blades Set, Hex Wrench, Thickness Gauge

Continuous rating input	710W
Capacity	Steel up to 400 N/mm ² : 3.2mm Steel up to 600 N/mm ² : 2.5mm Steel up to 800 N/mm ² : 1.5mm Aluminum up to 200 N/mm ² : 4.0mm
Min. cutting radius	50mm (2")
Strokes Per Minute (SPM)	1,600
Dimensions (L x W x H)	213x90x239mm (8-3/8"x3-1/2"x9-3/8")
Net Weight	3.4kg (7.4lbs)
Power supply cord	2.5m (8.2ft)

DJN161Z 1.6mm (16Ga) Cordless Nibbler

Nibbler without cord expands more operating field



Li-ion Ah 6.0 | 5.0 | 3.0 | 1.5



Capacity	Steel up to 400 N/mm ² : 1.6 mm Steel up to 600 N/mm ² : 1.2 mm Aluminum up to 200 N/mm ² : 2.5 mm
Min. cutting radius	Inside edge: 45 mm (1-3/4") Outside edge: 50 mm (2")
Strokes Per Minute (SPM)	1,900
Dimensions (L x W x H)	313x78x189 mm (12-3/8"x3-1/16"x7-7/16")
Net weight	1.9 - 2.3 kg (4.3 - 5.0 lbs)

18V LXT 4

Hex Wrench, Wrench, Punch, Die, Z: Battery and Charger are sold separately

JN1601 1.6mm (16Ga) Nibbler

2,200 SPM for faster and smooth cutting



Continuous rating input Capacity	550W Steel up to 400 N/mm ² : 1.6mm Steel up to 600 N/mm ² : 1.2mm Steel up to 800 N/mm ² : 0.8mm Aluminum up to 200N/mm ² : 2.5mm
Min. cutting radius	Outside edge: 50mm (2") Inside edge: 45mm (1-3/4")
Strokes Per Minute (SPM)	2,200
Overall Length	261 mm (10-1/4")
Net Weight	1.6kg (3.6lbs)
Power supply cord	2.0m (6.6ft)

5

Hex Wrench, Wrench, Punch, Die

JN3201J 3.2mm (10Ga) Nibbler

Robust design with elastomer coated handle provides easy operation



Continuous rating input Capacity	710W Steel up to 400 N/mm ² : 3.2mm Steel up to 600 N/mm ² : 2.5mm Steel up to 800 N/mm ² : 1.0mm Aluminum up to 200N/mm ² : 3.5mm
Strokes Per Minute (SPM)	1,300
Dimensions (L x W x H)	225x90x254mm (8-7/8"x1-1/2"x10")
Net Weight	3.4kg (7.4lbs)
Power supply cord	2.5m (8.2ft)

1

Punch, Die, Wrench 50, Hex Wrench, Washer

CA5000X 118mm (4-5/8") Aluminum Groove Cutter

Developed for cutting grooves in aluminum composite materials



Continuous Rating Input	1,300W
Blade	Type: Cutter blade / TCT saw blade
Max Cutting Capacity with Cutter blade	with Guide rail: 11mm (7/16")
Max Cutting Capacity with TCT Saw blade	with Guide rail: 36mm (1-7/16") without Guide rail: 41mm (1-5/8")
No Load Speed (RPM)	2,200-6,400
Dimension (L x W x H)	346x250x250mm (13-5/8"x9-7/8"x9-7/8")
Net Weight	4.7kg (10.4lbs)
Power Supply Cord	2.5m (8.2ft)

1

Cutter blade, Plate, Hex Wrench 5

GRINDER

PRODUCTS



GA038GZ

230mm (9") Cordless Angle Grinder

40Vmax XGT BL Cordless 230 mm (9") Angle Grinder, Large Trigger Switch

Li-ion Ah 5.0 | 4.0 | 2.5 | 2.0



Wheel Diameter	230 mm (9")
Hole Diameter	22.23 mm (7/8")
No Load Speed (RPM)	6,600
Dimensions (L x W x H)	w/BL4025: 497 x 250 x 156 mm (19-1/2 x 9-7/8 x 6-1/8") w/BL4040: 509 x 250 x 164 mm (20 x 9-7/8 x 6-1/2")
Net weight	4.6 - 7.4 kg (10.1 - 16.3 lbs.)

40Vmax



Toolless Wheel Cover, Anti-Vibration Grip, Wireless Unit (country-specific), Interchangeable Adapter ADP10 (country-specific), Toolless Lock Nut (country-specific), Battery, Charger, Z: Battery and Charger are sold separately

GA037GZ

180mm (7") Cordless Angle Grinder

40Vmax XGT BL Cordless 180mm (7") Angle Grinder, Large Trigger Switch

Li-ion Ah 5.0 | 4.0 | 2.5 | 2.0



Wheel Diameter	180 mm (7")
Hole Diameter	22.23 mm (7/8")
No Load Speed (RPM)	7,800
Dimensions (L x W x H)	w/BL4025: 497 x 200 x 156 mm (19-1/2 x 7-7/8 x 6-1/8") w/BL4040: 509 x 200 x 164 mm (20 x 7-7/8 x 6-1/2")
Net weight	4.4 - 5.4 kg (9.7 - 11.9 lbs.)

40Vmax



Toolless Wheel Cover, Anti-Vibration Grip, Wireless Unit (country-specific), Interchangeable Adapter ADP10 (country-specific), Toolless Lock Nut (country-specific), Battery, Charger, Z: Battery and Charger are sold separately

GA051GZ
150mm (6") Cordless Angle Grinder

New

40Vmax Cordless Angle Grinder, Anti-Restart Function, Electric Brake, Paddle Switch

Li-ion Ah 8.0 | 5.0 | 4.0 | 2.5 | 2.0



Wheel Diameter	150 mm (6")
Hole Diameter	22.23 mm (7/8")
No Load Speed (RPM)	9,000
Dimensions (L x W x H)	w/BL4025: 398 x 171 x 156 mm (15-5/8 x 6-3/4 x 6-1/8") w/BL4050F: 436 x 171 x 185 mm (17-1/8 x 6-3/4 x 7-1/4")
Net weight	3.1 - 4.7 kg (6.8 - 10.4 lbs.)

40Vmax



XGT BL AFT XPT

Depressed center wheel, Cutting wheel cover attachment, Toolless wheel cover, Side grip or Vibration proof grip (country-specific), Lock nut wrench, Battery, Charger, Z: Battery and Charger are sold separately

GA050GZ
125mm (5") Cordless Angle Grinder

New

40Vmax Cordless Angle Grinder, Anti-Restart Function, Electric Brake, Paddle Switch

Li-ion Ah 8.0 | 5.0 | 4.0 | 2.5 | 2.0



Wheel Diameter	125 mm (5")
Hole Diameter	22.23 mm (7/8")
No Load Speed (RPM)	11,000
Dimensions (L x W x H)	w/BL4025: 398 x 140 x 156 mm (15-5/8 x 5-1/2 x 6-1/8") w/BL4050F: 436 x 140 x 185 mm (17-1/8 x 5-1/2 x 7-1/4")
Net weight	3.0 - 5.4 kg (6.6 - 11.9 lbs.)

40Vmax



XGT BL AFT XPT

Depressed center wheel, Cutting wheel cover attachment, Toolless wheel cover, Side grip or Vibration proof grip (country-specific), Lock nut wrench, Battery, Charger, Z: Battery and Charger are sold separately

GA044GM201(RM2J) / GD201(RD2J) / GZ
125mm (5") Cordless Angle Grinder

40Vmax XGT BL AWS AFT Cordless Angle Grinder, Electric Brake, Paddle Switch, X-LOCK

Li-ion Ah 8.0 | 5.0 | 4.0 | 2.5 | 2.0



Wheel Diameter	125 mm (5")
Hole Diameter	22.23 mm (7/8")
No Load Speed (RPM)	3,000 - 8,500
Dimensions (L x W x H)	w/BL4040: 433 x 140 x 168 mm (17 x 5-1/2 x 6-5/8")
Net weight	3.0 - 4.8 kg (6.6 - 10.6 lbs.)

40Vmax



XGT BL AFT AWS X-LOCK XPT

Band Saw Blade, Hex Wrench, Battery, Charger, Z: Battery and Charger are sold separately

GA013GZJ / GZ 125mm (5") Cordless Angle Grinder

40Vmax XGT BL AFT Cordless Angle Grinder, Electric Brake, Paddle Switch

Li-ion Ah 5.0 | 4.0 | 2.5 | 2.0



GA013GZ
3

Wheel Diameter	125 mm (5")
Hole Diameter	22.23 mm (7/8")
No Load Speed (RPM)	8,500
Dimensions (L x W x H)	w/BL4025: 398x140x156 mm (15-5/8"x5-1/2"x6-1/8") w/BL4040: 410x140x168 mm (16-1/8"x5-1/2"x6-5/8")
Net weight	3.0 - 3.6 kg (6.6 - 7.9 lbs.)

40Vmax



XGT BL AFT XPT

Grinding Wheel, Toolless Wheel Cover, Side Grip, Lock Nut Wrench, Battery, Charger, Z: Battery and Charger are sold separately

GA036GZ / GA035GZ
150mm (6") Cordless Angle Grinder

40Vmax XGT BL AFT, Anti-Restart Function, Electric Brake

Li-ion Ah 5.0 | 4.0 | 2.5 | 2.0



Wheel Diameter	150 mm (6")
Hole Diameter	22.23 mm (7/8")
No Load Speed (RPM)	8,500
Dimensions (L x W x H)	w/BL4020 / BL4025: 398 x 171 x 156 mm (15-5/8 x 6-3/4 x 6-1/8") w/BL4040: 410 x 171 x 168 mm (16-1/8 x 6-3/4 x 6-5/8")
Net weight	3.0 - 3.7 kg (6.6 - 8.2 lbs.)

GA036GZ / GA035GZ

40Vmax



XGT BL AFT XPT

3

Grinding Wheel, Toolless Wheel Cover, Side Grip, Lock Nut Wrench, Battery, Charger, Z: Battery and Charger are sold separately



GA029GZJ / GZ 125mm (5") Cordless Angle Grinder

40Vmax XGT BL AWS AFT Cordless Angle Grinder, Electric Brake, Paddle Switch

Li-ion Ah 5.0 | 4.0 | 2.5 | 2.0



GA029GZ
3

Wheel Diameter	125 mm (5")
Hole Diameter	22.23 mm (7/8")
No Load Speed (RPM)	3,000 - 8,500
Dimensions (L x W x H)	w/BL4025: 413x140x156 mm (16-1/4"x5-1/2"x6-1/8") w/BL4040: 425x140x168 mm (16-3/4"x5-1/2"x6-5/8")
Net weight	3.0 - 4.5 kg (6.6 - 9.9 lbs.)

40Vmax



XGT BL AFT AWS XPT

Grinding Wheel, Toolless Wheel Cover, Side Grip, Lock Nut Wrench, Battery, Charger, Z: Battery and Charger are sold separately

GA023GZJ / GZ 125mm (5") Cordless Angle Grinder

40Vmax XGT BL AWS AFT Cordless Angle Grinder, Electric Brake, Slide Switch Lock-On

Li-ion Ah 5.0 | 4.0 | 2.5 | 2.0



GA023GZ
3

Wheel Diameter	125 mm (5")
Hole Diameter	22.23 mm (7/8")
No Load Speed (RPM)	3,000 - 8,500
Dimensions (L x W x H)	w/BL4025: 413x140x156 mm (16-1/4"x5-1/2"x6-1/8") w/BL4040: 425x140x168 mm (16-3/4"x5-1/2"x6-5/8")
Net weight	3.0 - 4.4 kg (6.6 - 9.7 lbs.)

40Vmax



XGT BL AFT AWS XPT

Grinding Wheel, Toolless Wheel Cover, Side Grip, Lock Nut Wrench, Battery, Charger, Z: Battery and Charger are sold separately

GA005GZ 125mm (5") Cordless Angle Grinder

40Vmax XGT BL AFT Cordless Angle Grinder, Electric Brake, Slide Switch Lock-On

Li-ion Ah 5.0 4.0 2.5 2.0



Wheel Diameter	125 mm (5")
Hole Diameter	22.23 mm (7/8")
No Load Speed (RPM)	8,500
Dimensions (L x W x H)	w/BL4025: 398x140x156 mm (15-5/8"x5-1/2"x6-1/8") w/BL4040: 410x140x168 mm (16-1/8"x5-1/2"x6-5/8")
Net weight	2.9 - 3.6 kg (6.4 - 7.9 lbs.)

GA028GZJ / GZ 115mm (4-1/2") Cordless Angle Grinder

40Vmax XGT BL AWS AFT Cordless Angle Grinder, Electric Brake, Paddle Switch

Li-ion Ah 5.0 4.0 2.5 2.0



Wheel Diameter	115 mm (4-1/2")
Hole Diameter	22.23 mm (7/8")
No Load Speed (RPM)	3,000 - 8,500
Dimensions (L x W x H)	w/BL4025: 413x130x156 mm (16-1/4"x5-1/8"x6-1/8") w/BL4040: 425x130x168 mm (16-3/4"x5-1/8"x6-5/8")
Net weight	3.0 - 3.6 kg (6.6 - 7.9 lbs.)

40Vmax



XGT BL AFT XPT



Grinding Wheel, Toolless Wheel Cover / Wheel Cover, Side Handle, Lock Nut Wrench, Battery, Charger, Z: Battery and Charger are sold separately

40Vmax



XGT BL AFT AWS XPT



Grinding Wheel, Toolless Wheel Cover, Side Grip, Lock Nut Wrench, Battery, Charger, Z: Battery and Charger are sold separately



AWS

Auto-start Wireless System

Switch on the tool, and Vacuum cleaner is activated

It has been impossible, but now Vacuum cleaner can be automatically activated by Cordless tools with our newly developed wireless system.



Bluetooth AWS connects to power tool with Bluetooth

The Bluetooth® word mark and logos are registered trademarks owned by the Bluetooth SIG, Inc. and any use of such marks by Makita is under license. Other trademarks and trade names are those of their respective owners.

ADT

Automatic torque Drive Technology automatically changes the cutting speed according to load conditions for an optimum operation

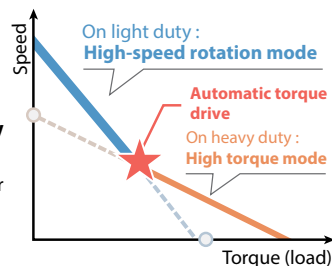

XLOCK

Just one click to attach the accessories and easy removal just simply pull the lever



AFT

Active Feedback sensing Technology Shuts down the tool to protect the user, if the rotation speed suddenly slows down.

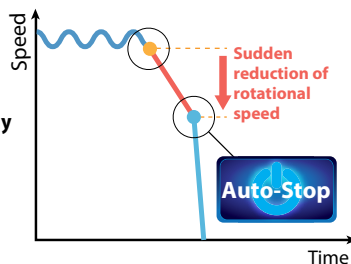

BL MOTOR

delivers optimal performance and efficiency even for heavy-duty applications



Electric brake

maximizes productivity and increases safety for operator

GA012GZ / GZ 115mm (4-1/2") Cordless Angle Grinder

40Vmax XGT BL AFT Cordless Angle Grinder, Electric Brake, Paddle Switch

Li-ion Ah 5.0 4.0 2.5 2.0



Wheel Diameter	115 mm (4-1/2")
Hole Diameter	22.23 mm (7/8")
No Load Speed (RPM)	8,500
Dimensions (L x W x H)	w/BL4025: 398x130x156 mm (15-5/8"x5-1/8"x6-1/8") w/BL4040: 410x130x168 mm (16-1/8"x5-1/8"x6-5/8")
Net weight	3.0 - 3.6 kg (6.6 - 7.9 lbs.)



40Vmax XGT BL AFT XPT

Grinding Wheel, Toolless Wheel Cover, Side Grip, Lock Nut Wrench, Battery, Charger, Z: Battery and Charger are sold separately

GA004GZ 115mm (4-1/2") Cordless Angle Grinder

40Vmax XGT BL AFT Cordless Angle Grinder, Electric Brake, Slide Switch Lock-On

Li-ion Ah 5.0 4.0 2.5 2.0



Wheel Diameter	115 mm (4-1/2")
Hole Diameter	22.23 mm (7/8")
No Load Speed (RPM)	8,500
Dimensions (L x W x H)	w/BL4025: 398x130x156 mm (15-5/8"x5-1/8"x6-1/8") w/BL4040: 410x130x168 mm (16-1/8"x5-1/8"x6-5/8")
Net weight	2.9 - 3.5 kg (6.4 - 7.7 lbs.)

40Vmax XGT BL AFT XPT 3

Grinding Wheel, Toolless Wheel Cover / Wheel Cover, Side Handle, Lock Nut Wrench, Battery, Charger, Z: Battery and Charger are sold separately

GA042GZJ / GZ 100mm (4") Cordless Angle Grinder

40Vmax XGT BL AWS AFT Cordless Angle Grinder, Electric Brake, Paddle Switch, X-LOCK

Li-ion Ah 5.0 4.0 2.5 2.0



Wheel Diameter	100 mm (4")
Hole Diameter	16 mm (5/8")
No Load Speed (RPM)	3,000 - 8,500
Dimensions (L x W x H)	w/BL4040: 433 x 117 x 162 mm (17 x 4-5/8 x 6-3/8")
Net weight	3.0 - 4.8 kg (6.6 - 10.6 lbs.)

40Vmax XGT BL AFT AWS X-LOCK XPT

Band Saw Blade, Hex Wrench, Battery, Charger, Z: Battery and Charger are sold separately

GA011GD201(RD2J) / GZ 100mm (4") Cordless Angle Grinder

40Vmax XGT BL AFT Cordless Angle Grinder, Electric Brake, Paddle Switch

Li-ion Ah 5.0 4.0 2.5 2.0



Wheel Diameter	100 mm (4")
Hole Diameter	16 mm (5/8")
No Load Speed (RPM)	8,500
Dimensions (L x W x H)	w/BL4025: 398x117x150 mm (15-5/8"x4-5/8"x5-7/8") w/BL4040: 410x117x162 mm (16-1/8"x4-5/8"x6-3/8")
Net weight	2.8 - 3.4 kg (6.2 - 7.5 lbs.)



40Vmax XGT BL AFT XPT

Grinding Wheel, Toolless Wheel Cover / Wheel Cover, Side Handle, Lock Nut Wrench, Battery, Charger, Z: Battery and Charger are sold separately

GA022GZJ / GZ 115mm (4-1/2") Cordless Angle Grinder

40Vmax XGT BL AWS AFT Cordless Angle Grinder, Electric Brake, Slide Switch Lock-On

Li-ion Ah 5.0 4.0 2.5 2.0



Wheel Diameter	115 mm (4-1/2")
Hole Diameter	22.23 mm (7/8")
No Load Speed (RPM)	3,000 - 8,500
Dimensions (L x W x H)	w/BL4025: 413x130x156 mm (16-1/4"x5-1/8"x6-1/8") w/BL4040: 425x130x168 mm (16-3/4"x5-1/8"x6-5/8")
Net weight	3.0 - 3.6 kg (6.6 - 7.9 lbs.)



40Vmax XGT BL AFT AWS XPT

Grinding Wheel, Toolless Wheel Cover, Side Grip, Lock Nut Wrench, Battery, Charger, Z: Battery and Charger are sold separately

GA048GZ 100mm (4") Cordless Angle Grinder

New

40Vmax Cordless Angle Grinder, Anti-Restart Function, Electric Brake, Paddle Switch

Li-ion Ah 5.0 4.0 2.5 2.0



Wheel Diameter	100 mm (4")
Hole Diameter	16 mm (5/8")
No Load Speed (RPM)	11,000
Dimensions (L x W x H)	w/BL4025: 398 x 117 x 156 mm (15-5/8 x 4-5/8 x 6-1/8") w/BL4050F: 436 x 117 x 185 mm (17-1/8 x 4-5/8 x 7-1/4")
Net weight	2.8 - 3.2 kg (6.2 - 11.5 lbs.)

40Vmax XGT BL AFT XPT

Depressed center wheel, Cutting wheel cover attachment, Toolless wheel cover, Side grip or Vibration proof grip (country-specific), Lock nut wrench, Battery, Charger, Z: Battery and Charger are sold separately

GA027GZJ / GZ 100mm (4") Cordless Angle Grinder

40Vmax XGT BL AWS AFT Cordless Angle Grinder, Electric Brake, Paddle Switch

Li-ion Ah 5.0 4.0 2.5 2.0



Wheel Diameter	100 mm (4")
Hole Diameter	16 mm (5/8")
No Load Speed (RPM)	3,000 - 8,500
Dimensions (L x W x H)	w/BL4025: 413x117x150 mm (16-1/4"x4-5/8"x5-7/8") w/BL4040: 425x117x162 mm (16-3/4"x4-5/8"x6-3/8")
Net weight	2.9 - 3.4 kg (6.4 - 7.5 lbs.)

40Vmax XGT BL AFT AWS XPT

Grinding Wheel, Toolless Wheel Cover, Side Grip, Lock Nut Wrench, Battery, Charger, Z: Battery and Charger are sold separately

GA003GM201(RM2J) / GD201(RD2J) / GZ 100mm (4") Cordless Angle Grinder

40Vmax XGT BL AFT Cordless Angle Grinder, Electric Brake, Slide Switch Lock-On

Li-ion Ah 5.0 4.0 2.5 2.0



Wheel Diameter	100 mm (4")
Hole Diameter	16 mm (5/8")
No Load Speed (RPM)	8,500
Dimensions (L x W x H)	w/BL4025: 398x117x150 mm (15-5/8"x4-5/8"x5-7/8") w/BL4040: 410x117x162 mm (16-1/8"x4-5/8"x6-3/8")
Net weight	2.8 - 3.3 kg (6.2 - 7.3 lbs.)



40Vmax XGT BL AFT XPT

Grinding Wheel, Toolless Wheel Cover / Wheel Cover, Side Handle, Lock Nut Wrench, Battery, Charger, Z: Battery and Charger are sold separately



Just One Click

X LOCK Quick and Effortless Wheel Change System

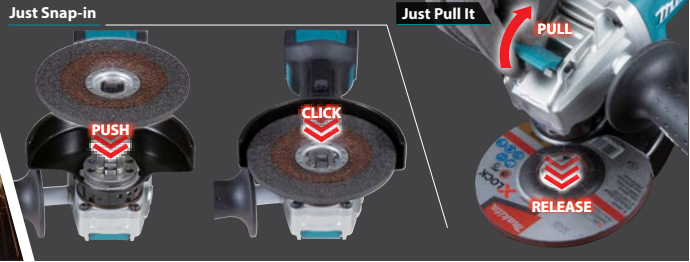

DGA517RTE / Z 125mm (5") Cordless Angle Grinder

Variable Speed, Anti-Restart Function, Electric Brake, Paddle Switch

Li-ion Ah 6.0 5.0 3.0 1.5



DGA517RTE 2
DGA517Z 3

Wheel Diameter	125 mm (5")
No Load Speed (RPM)	3,000 - 8,500
Dimensions (L x W x H)	with BL1815N: 368x140x151 mm (14-1/2"x5-1/2"x6") with BL1830B / BL1850B / BL1860B: 382x140x151 mm (15"x5-1/2"x6")
Net weight	2.4 - 3.1 kg (5.2 - 6.7 lbs.)

18V LXT BL ADT AFT XPT

Grinding Wheel, Wheel Cover, Side Grip, Lock Nut Wrench, Battery, Fast Charger, Z: Battery and Charger are sold separately

DGA508RTE / Z 125mm (5") Cordless Angle Grinder

Excellent performance and User protection

Li-ion Ah 6.0 5.0 3.0 1.5



DGA508RTE 2
DGA508Z 4

Wheel Diameter	125 mm (5")
No Load Speed (RPM)	8,500
Dimensions (L x W x H)	362x140x151 mm (14-1/4"x5-1/2"x5-15/16")
Net weight	2.35 - 3.83 kg (5.18 - 8.45 lbs)

18V LXT BL ADT AFT XPT

Fast charger, Battery cartridge, Depressed center grinding wheel, Lock nut wrench, Side grip, Z: Battery and Charger are sold separately

DGA513RTE / Z 125mm (5") Cordless Angle Grinder

Variable Speed, Anti-Restart Function, Electric Brake, Slide Switch Lock-On

Li-ion Ah 6.0 5.0 3.0 1.5



DGA513RTE 2
DGA513Z 3

Wheel Diameter	125 mm (5")
No Load Speed (RPM)	3,000 - 8,500
Dimensions (L x W x H)	with BL1815N: 368x140x151 mm (14-1/2"x5-1/2"x5-15/16") with BL1830B / BL1850B / BL1860B: 382x140x151 mm (15"x5-1/2"x5-15/16")
Net weight	2.4 - 3.0 kg (5.2 - 6.7 lbs.)

18V LXT BL ADT AFT XPT

Grinding Wheel, Wheel Cover, Side Grip, Lock Nut Wrench, Battery, Fast Charger, Z: Battery and Charger are sold separately

DGA506RTE / Z 125mm (5") Cordless Angle Grinder

Excellent performance and user protection

Li-ion Ah 6.0 5.0 3.0 1.5



DGA506RTE 2
DGA506Z 3

Wheel Diameter	125 mm (5")
No Load Speed (RPM)	8,500
Dimensions (L x W x H)	362x140x151 mm (14-1/4"x5-1/2"x5-15/16")
Net weight	2.35 - 3.83 kg (5.18 - 8.45 lbs)

18V LXT BL ADT AFT XPT

Fast charger, Battery cartridge, Depressed center grinding wheel, Lock nut wrench, Side grip, Z: Battery and Charger are sold separately

DGA469Z 115mm (4-1/2") Cordless Angle Grinder

X-LOCK for toolless accessory changes

Li-ion Ah 6.0 5.0 3.0 1.5



Wheel Diameter	115 mm (4-1/2")
Hole Diameter	22.23 mm (7/8")
Max Wheel Thickness	6 mm (1/4")
No Load Speed (RPM)	3,000 - 8,500
Dimensions (L x W x H)	396x130x147 mm (15-1/2"x5-1/8"x5-3/4")
Net weight	2.5 - 3.1 kg (5.5 - 6.8 lbs.)

18V LXT BL ADT AFT XLOCK XPT 3

Grinding Wheel, Wheel Cover, Side Grip, Lock Nut Wrench, Battery, Charger, Z: Battery and Charger are sold separately



DGA419Z 100mm (4") Cordless Angle Grinder

X-LOCK for toolless accessory changes

Li-ion Ah 6.0 5.0 3.0 1.5



Wheel Diameter	100 mm (4")
Hole Diameter	22.23 mm (7/8")
Max Wheel Thickness	6 mm (1/4")
No Load Speed (RPM)	3,000 - 8,500
Dimensions (L x W x H)	396x117x147mm (15-1/2"x4-5/8"x5-3/4")
Net weight	2.4 - 3.0 kg (5.3 - 6.6 lbs.)

18V **LXT BL ADT AFT** **X-LOCK XPT**
 Grinding Wheel, Wheel Cover, Side Grip, Lock Nut Wrench, Battery, Charger,
 Z: Battery and Charger are sold separately

DGA417RTE / Z 100mm (4") Cordless Angle Grinder

Variable Speed, Anti-Restart Function, Electric Brake, Paddle Switch

Li-ion Ah 6.0 5.0 3.0 1.5



Wheel Diameter	100 mm (4")
No Load Speed (RPM)	3,000 - 8,500
Dimensions (L x W x H)	with BL1815N: 368x117x146 mm (14-1/2"x4-5/8"x5-3/4") with BL1830B / BL1850B / BL1860B: 382x117x146 mm (15"x4-5/8"x5-3/4")
Net weight	2.2 - 2.9 kg (4.9 - 6.3 lbs.)

18V **LXT BL ADT AFT** **XPT**
 Grinding Wheel, Wheel Cover, Side Grip, Lock Nut Wrench, Battery, Fast Charger,
 Z: Battery and Charger are sold separately



Variable speed control dial (3,000 - 8,500 RPM)

Matches the speed to your application.



	No load speed (RPM)	Cutting / Rough grinding	Grinding / Finish grinding	Rust removal / Paint removal	Stainless steel polishing
1	3,000				✓
2	4,500			✓	✓
3	6,000		✓	✓	✓
4	7,500		✓		
5	8,500	✓			



DGA408RTJ1 / Z 100mm (4") Cordless Angle Grinder

Excellent performance and User protection

Li-ion Ah 6.0 5.0 3.0 1.5



Wheel Diameter	100 mm (4")
No Load Speed (RPM)	8,500
Dimensions (L x W x H)	362x117x146 mm (14-1/4"x4-5/8"x5-3/4")
Net weight	2.18 - 2.80 kg (4.81 - 6.17 lbs)

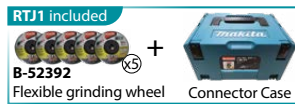

18V **LXT BL ADT AFT** **XPT**
 Fast charger, Battery cartridge, Depressed center grinding wheel, Lock nut wrench, Side grip,
 Z: Battery and Charger are sold separately

DGA413RTE / Z 100mm (4") Cordless Angle Grinder

Variable Speed, Anti-Restart Function, Electric Brake, Slide Switch Lock-On

Li-ion Ah 6.0 5.0 3.0 1.5



Wheel Diameter	100 mm (4")
No Load Speed (RPM)	3,000 - 8,500
Dimensions (L x W x H)	with BL1815N: 368x117x147 mm (14-1/2"x4-5/8"x5-3/4") with BL1830B / BL1850B / BL1860B: 382x117x147 mm (15"x4-5/8"x5-3/4")
Net weight	2.2 - 2.8 kg (4.9 - 6.2 lbs.)

18V **LXT BL ADT AFT** **XPT**
 Grinding Wheel, Wheel Cover, Side Grip, Lock Nut Wrench, Battery, Fast Charger,
 Z: Battery and Charger are sold separately

DGA406RTE / RFE / ZK / Z 100mm (4") Cordless Angle Grinder

Excellent performance and User protection

Li-ion Ah 6.0 5.0 3.0 1.5



Wheel Diameter	100 mm (4")
No Load Speed (RPM)	8,500
Dimensions (L x W x H)	362x117x146 mm (14-1/4"x4-5/8"x5-3/4")
Net weight	2.18 - 2.77 kg (4.81 - 6.12 lbs)



18V **LXT BL ADT AFT** **XPT**
 Fast charger, Battery cartridge, Depressed center grinding wheel, Lock nut wrench, Side grip,
 Z: Battery and Charger are sold separately

9500NB 100mm (4") Angle Grinder

Compact and lightweight body works well in close quarters

411



Continuous Rating Input	570W
Wheel Diameter	100 mm (4")
No Load Speed (RPM)	12,000
Overall Length	253 mm (10")
Net Weight	1.9kg (3.5 - 4.3lbs)
Power Supply Cord	2.5m (8.2ft)

Depressed Center Wheel, Wheel Cover, Lock Nut Wrench

GA4031 100mm (4") Angle Grinder

Powerful 720 W motor with excellent heat resistance

459



Continuous Rating Input	720W
Wheel Diameter	100 mm (4")
No Load Speed (RPM)	11,000
Dimensions (L x W x H)	259x118x104mm (10-1/4"x4-5/8"x4-1/8")
Net Weight	1.7 - 2kg (3.77 - 4.41 lbs)
Power Supply Cord	2.5m (8.2ft)



Depressed Center Wheel, Lock Nut Wrench

GA4030 100mm (4") Angle Grinder

Small diameter barrel grip for added comfort

459



Continuous Rating Input	720W
Wheel Diameter	100 mm (4")
No Load Speed (RPM)	11,000
Vibration Level	Surface Grinding: 7.0 m/s ² Disc Sanding: 2.5 m/s ² or less
Sound Power Level	96 dB(A)
Dimensions (L x W x H)	266x117x95mm (10-1/2"x4-5/8"x3-3/4")
Net Weight	1.73 - 2.02kg (3.81 - 4.45lbs)
Power Supply Cord	2.5m (8.2ft)



Depressed Center Wheel, Lock Nut Wrench, Side Grip

9556HPG 100mm (4") Angle Grinder

Ergonomic paddle switch featured

325



9556HP/BX



Continuous Rating Input	840W
Wheel Diameter	100 mm (4")
No Load Speed (RPM)	11,000
Sound Power Level	96 dB(A)
Dimensions (L x W x H)	273x118x97mm (10-3/4"x4-5/8"x3-13/16")
Net Weight	1.6 - 2.0 kg (3.6 - 4.5 lbs)
Power Supply Cord	2.5 m (8.2 ft.)



Depressed Center Wheel, Lock Nut Wrench, Side Grip

9556HNG 100mm (4") Angle Grinder

Ergonomic slide switch featured

325



Continuous Rating Input	840W
Wheel Diameter	100 mm (4")
No Load Speed (RPM)	11,000
Dimensions (L x W x H)	271x118x97 mm (10-5/8"x4-5/8"x3-13/16")
Net Weight	1.6 - 2.0 kg (3.6 - 4.4 lbs)
Power Supply Cord	2.5 m (8.2 ft.)



Depressed Center Wheel, Side Grip, Wheel Cover, Lock Nut Wrench

GA4100 100mm (4") Angle Grinder

New

Anti-Restart Function, Soft Start, Slide Switch, Speed Adjusting Dial



Continuous Rating Input	850W
Wheel Diameter	100 mm (4")
Hole diameter	16 mm (5/8")
Max abrasive wheel thickness	6.4 mm (1/4")
No Load Speed (RPM)	2,800-11,000
Dimensions (L x W x H)	298 x 118 x 105 mm (11-3/4 x 4-5/8 x 4-1/8")
Net Weight	2.1 - 3.0 kg (4.6 - 6.6lbs.)
Power Supply Cord	2.5m (8.2ft)



Depressed center wheel, Lock nut wrench, Cutting wheel cover attachment, Wheel cover, Inner flange, Lock nut, Side grip

GA4040 100mm (4") Angle Grinder

"Super Joint System II" developed for effective vibration absorption

325



Continuous Rating Input	1,100W
Wheel Diameter	100 mm (4")
No Load Speed (RPM)	11,000
Sound Power Level	97 dB(A)
Dimensions (L x W x H)	303x117x111 mm (11-7/8"x4-5/8"x4-3/8")
Net Weight	2.2 - 2.5 kg (4.9 - 5.6 lbs)
Power Supply Cord	2.5 m (8.2 ft)



Depressed Center Wheel, Lock Nut Wrench, Side Grip

GA4050R 100mm (4") Angle Grinder

100 mm (4") 1,300 W Angle Grinder, Anti-Restart Function, Paddle Switch

260



Continuous Rating Input	1,300W
Wheel Diameter	100 mm (4")
No Load Speed (RPM)	11,000
Vibration Level	Surface Grinding w/ Normal Side Grip: 6.5 m/s ²
Sound Power Level	102 dB(A)
Dimensions (L x W x H)	325 x 117 x 100 mm (12-3/4 x 4-5/8 x 4-5/16")
Net Weight	2.3 - 2.6 kg (5.1 - 5.7 lbs.)
Power Supply Cord	2.5 m (8.2 ft)



Depressed Center Wheel, Side Grip, Wheel Cover, Lock Nut Wrench

GA4040C 100mm (4") Angle Grinder

"Super Joint System II" developed for effective vibration absorption

318



Continuous Rating Input	1,400W
Wheel Diameter	100 mm (4")
No Load Speed (RPM)	2,800-11,000
Sound Power Level	97 dB(A)
Dimensions (L x W x H)	303x117x111mm (11-7/8"x4-5/8"x4-3/8")
Net Weight	2.3 - 2.6kg (5.1 - 5.7lbs)
Power Supply Cord	2.5m (8.2ft)



Depressed Center Wheel, Lock Nut Wrench, Side Grip

GA4041C 100mm (4") Angle Grinder

Anti-Restart Function, Soft start, Mechanical Brake, Slide Switch 318



Continuous Rating Input	1,400W
Wheel Diameter	100 mm (4")
No Load Speed (RPM)	2,800-11,000
Dimensions (L x W x H)	325x117x117mm (12-3/4"x4-5/8"x4-5/8")
Net Weight	2.5 - 2.8kg (5.6 - 6.2 lbs)
Power Supply Cord	2.5m (8.2ft)



Depressed Center Wheel, Lock Nut Wrench, Side Grip

GA4034 100mm (4") Angle Grinder

Easy to operate paddle switch by the hand gripping motor housing 459



Continuous Rating Input	720W
Wheel Diameter	100 mm (4")
No Load Speed (RPM)	11,000
Vibration Level	Surface Grinding: 7.5 m/s ² Disc Sanding: 2.5 m/s ² or less
Sound Power Level	97 dB(A)
Dimensions (L x W x H)	265x118x95mm (10-3/8"x4-5/8"x3-3/4")
Net Weight	1.77 - 2.06kg (3.9 - 4.54 lbs)
Power Supply Cord	2.5m (8.2ft)



Depressed Center Wheel, Lock Nut Wrench, Side Grip

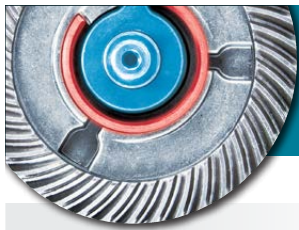

SJS II

SUPER JOINT SYSTEM

To suppress vibration to operator

without SJS



SJS II
SUPER JOINT SYSTEM



Structure of Super Joint System II

Leaf spring absorbs vibration and relieves shock during operation

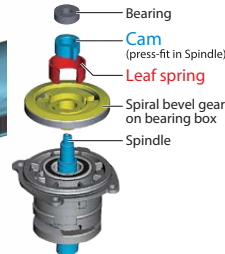
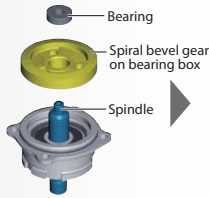

100mm Angle Grinder GA4040

Absorption mechanism of vibration

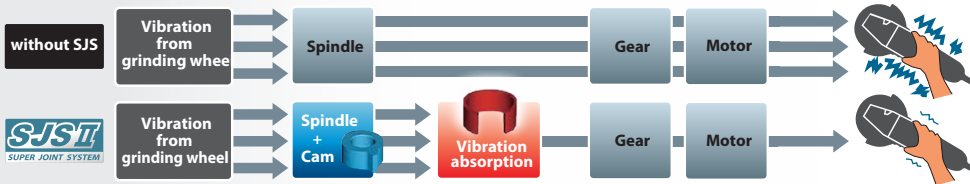

with Brake
100mm Angle Grinder GA4041C

9557HNG 115mm (4-1/2") Angle Grinder

840 W Angle Grinder, Anti-Restart Function, Soft Start, Slide Switch 325



Continuous Rating Input	840W
Wheel Diameter	115 mm (4-1/2")
No Load Speed (RPM)	11,000
Sound Power Level	97 dB(A)
Dimensions (L x W x H)	271x129x106 mm (10-5/8"x5-1/8"x4-3/16")
Net Weight	1.7 - 2.2 kg (3.8 - 5.3 lbs.)
Power Supply Cord	2.5 m (8.2 ft.)



Depressed Center Wheel, Side Grip, Wheel Cover, Lock Nut Wrench

GA4593X01 115mm (4-1/2") Angle Grinder

1,900 W SJS II AFT, Anti-Restart Function, Mechanical Brake, Paddle Switch



Continuous rating Input	1,900W
Wheel Diameter	115 mm (4-1/2")
Hole Diameter	22.23 mm (7/8")
No Load Speed (RPM)	2,800 - 11,500
Circumference of grip portion	207 mm (8-1/8")
Cutting depth	26 mm (1")
Dimensions (L x W x H)	349 x 130 x 129 mm (13-3/4 x 5-1/8 x 5-1/8")
Net weight	2.8 - 4.0 kg (6.2 - 8.8 lbs.)



Depressed center wheel, Side grip, Wheel cover, Lock nut wrench

GA4595 115mm (4-1/2") Angle Grinder

1,900 W SJS II AFT Angle Grinder, Anti-Restart Function, Soft Start, Paddle Switch



Continuous rating Input	1,900W
Wheel Diameter	115 mm (4-1/2")
Hole Diameter	22.23 mm (7/8")
No Load Speed (RPM)	2,800 - 11,500
Circumference of grip portion	207 mm (8-1/8")
Cutting depth	26 mm (1")
Dimensions (L x W x H)	326 x 130 x 123 mm (12-3/4 x 5-1/8 x 4-7/8")
Net weight	2.6 - 3.8 kg (5.7 - 8.4 lbs.)



Depressed center wheel, Side grip, Wheel cover, Lock nut wrench

GA5030 125mm (5") Angle Grinder

Small diameter barrel grip for added comfort



Continuous Rating Input	720W
Wheel Diameter	125 mm (5")
No Load Speed (RPM)	11,000
Sound Power Level	96 dB(A)
Dimensions (L x W x H)	266x138x103mm (10-1/2"x5-7/16"x4-1/16")
Net Weight	1.92 - 3.07kg (4.23 - 6.77lbs)
Power Supply Cord	2.5m (8.2ft)



Depressed Center Wheel, Lock Nut Wrench, Side Grip

GA5034 125mm (5") Angle Grinder

Easy to operate paddle switch by the hand gripping motor housing



Continuous Rating Input	720W
Wheel Diameter	125 mm (5")
No Load Speed (RPM)	11,000
Sound Power Level	97 dB(A)
Dimensions (L x W x H)	265x139x103mm (10-3/8"x5-1/2"x4-1/16")
Net Weight	2 - 3.15kg (4.41 - 6.94lbs)
Power Supply Cord	2.5m (8.2ft)



Depressed Center Wheel, Lock Nut Wrench, Side Grip

GA5100 125mm (5") Angle Grinder

New

Anti-Restart Function, Soft Start, Slide Switch, Speed Adjusting Dial



Continuous Rating Input	850W
Wheel Diameter	125 mm (5")
Hole diameter	22.23 mm (7/8")
Max abrasive wheel thickness	7.2 mm (9/32")
No Load Speed (RPM)	2,800-11,000
Dimensions (L x W x H)	298 x 140 x 111 mm (11-3/4 x 5-1/2 x 4-3/8")
Net Weight	2.2 - 3.2 kg (4.9 - 7.1lbs.)
Power Supply Cord	2.5m (8.2ft)



Depressed center wheel, Lock nut wrench, Cutting wheel cover attachment, Wheel cover, Inner flange, Lock nut, Side grip

GA5010 125mm (5") Angle Grinder

Refined design for reduced operator fatigue



110V
GA5010/B

Continuous Rating Input	1,050W
Wheel Diameter	125 mm (5")
No Load Speed (RPM)	12,000
Sound Power Level	100 dB(A)
Dimensions (L x W x H)	356x139x112mm (14"x5-1/2"x4-3/8")
Net Weight	2.6 - 3.8kg (5.8 - 8.4lbs)
Power Supply Cord	2.5m (8.2ft)



Depressed Center Wheel, Lock Nut Wrench, Side Grip

GA5050R 125mm (5") Angle Grinder

125 mm (5") 1,300 W Angle Grinder, Anti-Restart Function, Paddle Switch



Continuous Rating Input	1,300W
Wheel Diameter	125 mm (5")
No Load Speed (RPM)	11,000
Vibration Level	Surface Grinding w/ Normal Side Grip: 7.5 m/s ²
Sound Power Level	102 dB(A)
Dimensions (L x W x H)	325 x 140 x 117 mm (12-3/4 x 5-1/2 x 4-5/8")
Net Weight	2.5 - 2.8 kg (5.5 - 6.2 lbs.)
Power Supply Cord	2.5 m (8.2 ft)



Depressed Center Wheel, Side Grip, Wheel Cover, Lock Nut Wrench



GA5080R 125mm (5") Angle Grinder

125 mm (5") 1,400 W Angle Grinder, Soft Start, Slide Switch, X-LOCK



Continuous rating input	1,400W
Wheel Diameter	125 mm (5")
Hole Diameter	22.3 mm (7/8")
Max cutting depth	31 mm (1-1/4")
No Load Speed (RPM)	12,000
Dimensions (L x W x H)	309 x 141 x 113 mm (12-1/8 x 5-9/16 x 4-7/16")
Net weight	2.5 - 3.6 kg (5.5 - 7.9 lbs.)
Power supply cord	2.5 m (8.2 ft)



Depressed Center Wheel, Side Grip, Wheel Cover

GA5091X01 125mm (5") Angle Grinder

1,900 W SJS II AFT Grinder, Anti-Restart Function, Mechanical Brake, Slide Switch



Continuous rating Input	1,900W
Wheel Diameter	125 mm (5")
Hole Diameter	22.23 mm (7/8")
No Load Speed (RPM)	2,800 - 11,500
Circumference of grip portion	205 mm (8-1/8")
Dimensions (L x W x H)	349 x 140 x 129 mm (13-3/4 x 5-1/2 x 5-1/8")
Net weight	2.8 kg (6.2 lbs.)



Depressed center wheel, Side grip, Wheel cover, Lock nut wrench

GA6010 150mm (6") Angle Grinder

Externally accessible brushes for greater serviceability

303

110V



Continuous Rating Input	1,050W
Wheel Diameter	150 mm (6")
No Load Speed (RPM)	10,000
Sound Power Level	101 dB(A)
Dimensions (L x W x H)	356x169x112mm (14"x6-5/8"x4-3/8")
Net Weight	2.7 - 3.1kg (5.9 - 6.9lbs)
Power Supply Cord	2.5m (8.2ft)



Depressed Center Wheel, Lock Nut Wrench, Side Grip

GA6020C 150mm (6") Angle Grinder

Trigger Switch with Lock-On Button

253



Continuous Rating Input	1,450W
Wheel Diameter	150 mm (6")
No Load Speed (RPM)	9,000
Sound Power Level	102 dB(A)
Dimensions (L x W x H)	390 x 169 x 120 mm (15-3/8 x 6-5/8 x 4-3/4")
Net Weight	3 - 3.5 kg (6.7 - 7.6 lbs.)
Power Supply Cord	2.5m (8.2ft)



Depressed Center Wheel, Side grip, Wheel Cover, Lock nut wrench

GA7020 180mm (7") Angle Grinder

Outstanding durability

204



Continuous Rating Input	2,200W
Wheel Diameter	180 mm (7")
No Load Speed (RPM)	8,500
Sound Power Level	100 dB(A)
Dimensions (L x W x H)	473x200x140mm (18-5/8"x7-7/8"x5-1/2")
Net Weight	5.5 - 6.06kg (12.26 - 13.36 lbs)
Power Supply Cord	2.5m (8.2ft)

Tool does not come with depressed center wheel



Lock Nut Wrench, Side Grip

GA7060 180mm (7") Angle Grinder

Developed for heavy duty applications such as foundry grinding

218



Continuous Rating Input	2,200W
Wheel Diameter	180 mm (7")
No Load Speed (RPM)	8,500
Sound Power Level	102 dB(A)
Dimensions (L x W x H)	450x200x144mm (17-3/4"x7-7/8"x5-5/8")
Net Weight	5.38 - 5.89 kg (11.9 - 13lbs)
Power Supply Cord	2.5 m (8.2 ft)

Tool does not come with depressed center wheel



Side grip, Lock nut wrench

GA7090 180mm (7") Angle Grinder

New

2,200 W Angle Grinder, Large Trigger Switch



Continuous Rating Input	2,200W
Wheel Diameter	180 mm (7")
Dimensions (L x W x H)	437 x 200 x 144 mm (17-1/4 x 7-7/8 x 5-11/16")
Net Weight	5.1 kg (11 lbs.)



Side grip, Lock nut wrench, Cutting wheel cover attachment

GA7081 180mm (7") Angle Grinder

2,700 W Angle Grinder, Large Trigger Switch



Continuous rating input	2,700W
Wheel Diameter	180 mm (7")
No Load Speed (RPM)	8,500
Dimensions (L x W x H)	499 x 200 x 144 mm (19-5/8 x 7-7/8 x 5-5/8")
Net weight	6.1 - 6.6 kg
Power supply cord	2.5 m (8.2 ft)

without Rotatable Handle



Side Grip, Wheel Cover, Lock Nut Wrench

GA7070X1 180mm (7") Angle Grinder

2,800 W AFT Angle Grinder, Anti-Restart Function, Soft Start, Electric Brake, Large Trigger Switch

110V



Continuous rating input	2,800W
Wheel Diameter	180 mm (7")
Hole Diameter	22.23 mm (7/8")
No Load Speed (RPM)	8,500
Dimensions (L x W x H)	506 x 200 x 146 mm (20 x 7-7/8 x 5-3/4")
Net weight	6.1-6.6 kg (13.5 - 14.6 lbs.)
Power supply cord	2.5 m (8.2 ft)



Side Grip, Wheel Cover, Lock Nut Wrench

GA9060 230mm (9") Angle Grinder

Developed for heavy duty applications such as foundry grinding

218



Continuous Rating Input	2,200W
Wheel Diameter	230 mm (9")
No Load Speed (RPM)	6,600
Sound Power Level	102 dB(A)
Dimensions (L x W x H)	450x250x144mm (17-3/4"x9-7/8"x5-5/8")
Net Weight	5.50 - 7.86kg (12.1 - 17.3 lbs)
Power Supply Cord	2.5 m (8.2 ft)

Tool does not come with depressed center wheel



Side grip, Lock nut wrench

GA9020 230mm (9") Angle Grinder

Outstanding durability

204



Continuous Rating Input	2,200W
Wheel Diameter	230 mm (9")
No Load Speed (RPM)	6,000
Sound Power Level	100 dB(A)
Dimensions (L x W x H)	473x249x140mm (18-5/8"x9-3/4"x5-1/2")
Net Weight	5.76 - 8.05kg (12.7 - 17.8 lbs)
Power Supply Cord	2.5m (8.2ft)

Tool does not come with depressed center wheel



Lock Nut Wrench, Side Grip

GA9090 230mm (9") Angle Grinder

New

2,200 W Angle Grinder, Large Trigger Switch



Continuous Rating Input	2,200W
Wheel Diameter	230 mm (9")
Dimensions (L x W x H)	437 x 250 x 144 mm (17-1/4 x 9-7/8 x 5-11/16")
Net Weight	5.3 kg (11.6 lbs.)



Side grip, Lock nut wrench, Cutting wheel cover attachment

GA9081 230mm (9") Angle Grinder

2,700 W Angle Grinder, Large Trigger Switch



Continuous rating input	2,700W
Wheel Diameter	230 mm (9")
No Load Speed (RPM)	6,600
Dimensions (L x W x H)	499 x 250 x 144 mm (19-5/8 x 9-7/8 x 5-5/8")
Net weight	6.3 - 8.4 kg
Power supply cord	2.5 m (8.2 ft)

without Rotatable Handle



Side Grip, Wheel Cover, Lock Nut Wrench

GA9070X1 230mm (9") Angle Grinder

2,800 W AFT Angle Grinder, Anti-Restart Function, Soft Start, Electric Brake, Large Trigger Switch



Continuous rating input	2,800W
Wheel Diameter	230 mm (9")
Hole Diameter	22.23 mm (7/8")
No Load Speed (RPM)	6,600
Dimensions (L x W x H)	506 x 250 x 146 mm (20 x 9-7/8 x 5-3/4")
Net weight	6.3-8.5 kg (13.9 - 18.7 lbs.)
Power supply cord	2.5 m (8.2 ft)



Side Grip, Wheel Cover, Lock Nut Wrench

DGD800Z 8mm (1/4") Cordless Die Grinder

Now free from cord for easy job site portability

430

Li-ion Ah 6.0 5.0 3.0 1.5



Capacity	Collet : 3 mm - 8 mm
Wheel Diameter	38 mm (1-1/2")
No Load Speed (RPM)	26,000
Dimensions (L x W x H)	402x82x118 mm (15-3/4"x3-1/4"x4-5/8")
Net weight	1.7 - 2.2 kg (3.8 - 4.9 lbs)

18V LXT 3

Collet Cone, Wrench, Z: Battery and Charger are sold separately.

GD0600 6mm (1/4") Die Grinder

Small-circumference housing for easy handling

325



110V GD0600/B

Continuous Rating Input	400W
Capacity	Collet: 3,6mm or 1/8", 1/4"
Wheel Diameter	38 mm (1-1/2")
No Load Speed (RPM)	25,000
Dimensions (L x W x H)	358x82x82mm (14-1/8"x3-1/4"x3-1/4")
Net Weight	1.7 - 1.87kg (3.77 - 4.12 lbs)
Power Supply Cord	2.5m (8.2ft)



Wrench (2pcs)

GD0601 6mm (1/4") Die Grinder

Small-circumference housing for easy handling

325



Continuous Rating Input	400W
Capacity	Collet: 3,6mm or 1/8", 1/4"
Wheel Diameter	38 mm (1-1/2")
No Load Speed (RPM)	25,000
Dimensions (L x W x H)	359x82x82mm (14-1/8"x3-1/4"x3-1/4")
Net Weight	1.68 - 1.84kg (3.7 - 4.06 lbs)
Power Supply Cord	2.5m (8.2ft)



Wrench (2pcs)

GD0602 6mm (1/4") Die Grinder

Compact body with short nose

325



Continuous Rating Input	400W
Capacity	Collet: 3,6,8mm or 1/8",1/4"
Wheel Diameter	38 mm (1-1/2")
No Load Speed (RPM)	25,000
Dimensions (L x W x H)	264x82x82mm (10-3/8"x3-1/4"x3-1/4")
Net Weight	1.4kg (3.2lbs)
Power Supply Cord	2.5m (8.2ft)



5

Wrench (2pcs)

GD0603 6mm (1/4") Die Grinder

Easy handling, Compact Die grinder with new aesthetic design

64

110V
GD0603/B

Continuous Rating Input	240W
Capacity	Collet: 6mm or 1/4"
Max Wheel Diameter	19mm
No Load Speed (RPM)	28,000
Diameter of grip	65mm
Circumference of Grip	203mm
Dimensions (L x W x H)	289x64x67mm (11-3/8"x2-1/2"x2-5/8")
Net Weight	0.97kg (2.1lbs)
Power Supply Cord	2.5m (8.2ft)



6

Spanner 10 (x2), Wheel points

906/B 6mm (1/4") Die Grinder

Lightweight for controlled Grinding operations

64



110V

Continuous Rating Input	240W
Capacity	Collet: 6 mm or 1/4"
No Load Speed (RPM)	25,000
Overall Length	283 mm (14")
Net Weight	0.94 kg (2.1 lbs)
Power Supply Cord	2.5 m (8.2 ft)



10

Wheel Point (2pcs.), Wrench (2pcs.), Dressing Stone

GD0800C 8mm (1/4") Die Grinder

High-speed die grinder with max. 8mm collet capacity

318



Continuous Rating Input	750W
Capacity	Collet: 3,6,8mm or 1/8",1/4"
Wheel Diameter	25 mm (1")
No Load Speed (RPM)	7,000-28,000
Dimensions (L x W x H)	371x75x75mm (14-5/8"x2-15/16"x2-15/16")
Net Weight	1.88kg (4.14lbs)
Power Supply Cord	2.5m (8.2ft)

Tool does not come with depressed center wheel



Wrench x2

GS5000 125mm (5") Straight Grinder

"Tool-less" guard cap removal for more convenient wheel changes

204



Continuous Rating Input	750W
Wheel Diameter	125 mm (5")
Hole Diameter	12.7,20mm (1/2,13/16")
No Load Speed (RPM)	5,600
Dimensions (L x W x H)	590x189x116mm (23-1/4"x7-7/16"x4-9/16")
Net Weight	5.0 - 5.2kg (11.0 - 11.5 lbs)
Power Supply Cord	2.5m (8.2ft)



1



GB602 150mm (6") Bench Grinder

Steady tool maintenance from this light, yet stable performer



Continuous Rating Input	250W
Wheel Diameter	150 mm (6")
Wheel Width	16mm (5/8")
Hole Diameter	12.7mm (1/2")
H.P.	1/3
No Load Speed (RPM)	2,850 (50Hz) / 3,450 (60Hz)
Dimensions (L x W x H)	375x348x286mm (14-49/64"x 13-45/64"x11-17/64")
Net Weight	9.5kg



1

Eye Shield, Protection Glasses, Grinding wheel x 2

GB801 205mm (8") Bench Grinder

Steady tool maintenance from this light, yet stable performer



Continuous Rating Input	550W
Wheel Diameter	205 mm (8")
Wheel Width	19mm (3/4")
Hole Diameter	15.88mm (5/8")
H.P.	3/4
No Load Speed (RPM)	2,850 (50Hz) / 3,450 (60Hz)
Dimensions (L x W x H)	395x265x333mm (15-9/16"x 10-7/16"x13-7/64")
Net Weight	19.91 - 19.65kg (43.89 - 43.28lbs)



1

Eye Shield, Protection Glasses, Grinding wheel x 2

SAWING

PRODUCTS



LS003GZ 305mm (12") Cordless Slide Compound Miter Saw

LED light with ink line aligning function

Li-ion Ah 8.0 5.0 4.0 2.5 2.0



Blade Diameter	305 mm (12")
Miter Angle	60° L / 60° R
Bevel Angle	48° L / 48° R
Max Cutting Capacity	90° Miter: 107 x 363 mm (4-1/4 x 14-1/4") 90° Miter: 92 x 382 mm (3-5/8 x 15") 45° Miter, L/R: 107 x 255 mm (4-1/4 x 10") 45° Miter, L/R: 92 x 268 mm (3-5/8 x 10-1/2")
No Load Speed (RPM)	3,600
Dimensions (L x W x H)	898 x 690 x 725 mm
Net weight	30.0 - 30.6 kg (66.1 - 67.5 lbs.)

40Vmax XGT BL AWS DXT

TCT Saw Blade, Dust Bag, Triangular Rule, Vertical Vise, Hex Wrench, Battery, Charger, Z: Battery and Charger are sold separately

LS004GZ 260mm (10-1/4") Cordless Slide Compound Miter Saw

LED light with ink line aligning function

Li-ion Ah 8.0 5.0 4.0 2.5 2.0



Blade Diameter	260 mm (10-1/4")
Miter Angle	60° L / 60° R
Bevel Angle	48° L / 48° R
Max Cutting Capacity	90° Miter: 68 x 310 mm (2-11/16 x 12-1/4") 91 x 279 mm (3-5/8 x 11") 45° Miter, L/R: 68 x 218 mm (2-11/16 x 8-5/8") 91 x 197 mm (3-5/8 x 7-3/4")
No Load Speed (RPM)	3,600
Dimensions (L x W x H)	805 x 644 x 660 mm
Net weight	26.6 - 27.2 kg (58.6 - 60.0 lbs.)

40Vmax XGT BL AWS DXT

TCT Saw Blade, Dust Bag, Triangular Rule, Vertical Vise, Hex Wrench, Wireless unit set, Battery, Charger, Z: Battery and Charger are sold separately

LS002GZ 216mm (8-1/2") Cordless Slide Compound Miter Saw

More efficient dust extraction

Li-ion Ah 5.0 4.0 2.5 2.0



Blade Diameter	216 mm (8-1/2")
Miter Angle	60° L / 60° R
Bevel Angle	48° L / 48° R
Max Cutting Capacity	90° Miter: 70 x 312 mm (2-3/4 x 12-1/4") 27-5/8 x 21-3/4 x 22"
No Load Speed (RPM)	4,800
Dimensions (L x W x H)	702 x 551 x 557 mm
Net weight	16.4 - 17.0 kg (36.2 - 37.6 lbs.)

40Vmax XGT BL AWS DXT

TCT Saw Blade, Dust Bag, Triangular Rule, Vertical Vise, Hex Wrench, Battery, Charger, Z: Battery and Charger are sold separately

LS0714 190mm (7-1/2") Slide Compound Saw

Compact and Lightweight for Increased Jobsite Portability

303



Continuous Rating Input	1,010W
Max Cutting Capacity	90°: 52 x 300 mm (2-1/16" x 11-3/4") 45°: 52 x 212 mm (2-1/16" x 8-3/8")
Blade Diameter	190 mm (7-1/2")
No Load Speed (RPM)	6,000
Sound Power Level	101 dB(A)
Dimensions (L x W x H)	670x430x458mm (26-3/8"x17"x18")
Net Weight	13.1 kg (28.9 lbs)
Power Supply Cord	2.5m (8.2ft)

T.C.T Saw Blade, Socket Wrench, Dust Bag, Holder Set, Vertical Vise, Triangular Rule

LS1018L 260mm (10-1/4") Slide Compound Saw

Bevel cutting 45 degrees left and right

JM23000123



Continuous Rating Input	1,430W
Max Cutting Capacity	90°: 91 x 305 mm (3-5/8" x 12") 45°: 91 x 215 mm (3-5/8" x 8-1/2")
Blade Diameter	255 - 260 mm (10 - 10-1/4")
No Load Speed (RPM)	4,300
Sound Power Level	103 dB(A)
Dimensions (L x W x H)	825x536x633mm (32-1/2"x21-1/8"x25")
Net Weight	20.6kg (45.4lbs)
Power Supply Cord	2.5m (8.2ft)

Carbide - Tipped Saw Blade, Vertical Vise, Socket Wrench, Triangular Rule, Dust Bag, Holder Assembly

LS1019L 260mm (10-1/4") Slide Compound Miter Saw

260 mm (10-1/4") 1,510 W DXT Dual Slide Compound Miter Saw, Laser

153



Continuous Rating Input	1,510W
Blade Diameter	260 mm (10-1/4")
Bevel Angle	48° L / 48° R
Miter Angle	60° L / 60° R
Max Cutting Capacity (Bevel/Miter)	90°/90°: 68 / 310 mm (2-11/16" x 12-1/4") 90°/90°: 91 / 279 mm (3-5/8" x 11") 90°/45° L/R: 68 / 218 mm (2-11/16" x 8-5/8") 90°/45° L/R: 91 / 197 mm (3-5/8" x 7-3/4")
No Load Speed (RPM)	3,200
Dimensions (L x W x H)	805x644x660 mm (31-3/4"x25-3/8"x26")
Net Weight	26.3 kg (57.9 lbs.)
Power Supply Cord	2.5 m (8.2 ft.)

Dust Bag, Triangular Rule, Vertical Vise, Socket Wrench, Hex Wrench, Holder

LS1110F 255-260 mm (10 - 10-1/4") Slide Compound Miter Saw

New

Cuts up to 310 mm (12-1/4") at 90° and 220 mm (8-5/8") at 45°



Continuous Rating Input	1,450W
Max Cutting Capacity	Bevel 0° / Miter 0°: 91 x 310mm, Bevel 0° / Miter 45°LR: 91 x 220mm, Bevel 45°L / Miter 0°: 50 x 310mm Bevel 45°L / Miter 45°LR: 50 x 220mm 255 - 260 mm, Bevel 2°R / Miter 0°: 85 x 310mm
No Load Speed (RPM)	4,500
Dimensions (L x W x H)	745 x 497 x 565 mm (29-1/4 x 19-1/2 x 22-1/4")
Net Weight	16.4 kg (36.2 lbs.)
Power Supply Cord	2.0 m (6.6 ft)



Carbide-tipped saw blade, Vertical vise, Dust bag, Hex wrench



LED job light with cut line guide function

Miter at 0°	45° Bevel Cut at 45° left	Cross Cut	5° right
<p>With a 20mm (3/4") auxiliary wood fence</p>	<p>45x265 (1-3/4" x 10-3/8") 40 x 300 mm (1-9/16" x 11-3/4")</p>	<p>60x265 (2-3/8" x 10-3/8") 52 x 300 mm (2-1/16" x 11-3/4")</p>	<p>40 x 300 mm (1-9/16" x 11-3/4")</p>
<p>With a 15mm (3/5") auxiliary wood fence</p>	<p>45x185 (1-3/4" x 7-1/4") 40 x 212 mm (1-9/16" x 8-3/8")</p>	<p>60x185 (2-3/8" x 7-1/4") 52 x 212 mm (2-1/16" x 8-3/8")</p>	-
<p>With a 10mm (3/8") auxiliary wood fence</p>	-	<p>60x145 (2-3/8" x 5-3/4") 52 x 163 mm (2-1/16" x 6-3/8")</p>	-

LS1219L 305mm (12") Slide Compound Miter Saw

305 mm (12") 1,800 W Slide Compound Miter Saw, Laser

153



Continuous Rating Input	1,800W
Blade Diameter	305 mm (12")
Bevel Angle	48° L / 48° R
Miter Angle	60° L / 60° R
Max Cutting Capacity	90°: 107 x 363 mm (4-1/4" x 14-1/4") 45°: 107 x 255 mm (4-1/4" x 10")
No Load Speed (RPM)	3,200
Dimensions (L x W x H)	898x644x725mm (35-1/4"x25-3/8"x28-1/2")
Net Weight	29.3 kg (64.6 lbs)
Power Supply Cord	2.5 m (8.2 ft.)



Vertical Vise, Hex Wrench, Triangular Rule, Dust Bag

LS1040 260mm (10-1/4") Compound Miter Saw

Robust construction for consistently accurate cuts

153



Continuous Rating Input	1,650W
Max Cutting Capacity	90°: 90.5 x 95 mm (3-9/16" x 3-3/4") 45°: 90.5 x 67 mm (3-9/16" x 2-5/8")
Blade Diameter	260 mm (10-1/4")
No Load Speed (RPM)	4,600
Sound Power Level	106 dB(A)
Dimensions (L x W x H)	530x476x532mm (20-7/8"x18-3/8"x21")
Net Weight	12.4kg (27.3lbs)
Power Supply Cord	2.5m (8.2ft)

Tool does not come with saw blade



Carbide-tipped saw blade, Vise assembly, Dust bag, Socket wrench 13, Triangular rule, Sub plate assembly, Holder x 2

LS1440 355mm (14") Miter Saw

Clean miter cutting up to 45 degrees, right or left

153



Continuous Rating Input	1,380W
Max Cutting Capacity	90°: 122 x 152 mm (4-13/16" x 6") 45°: 122 x 115 mm (4-13/16" x 4-1/2")
Blade Diameter	355 mm (14")
No Load Speed (RPM)	3,200
Dimensions (L x W x H)	530x596x435mm (20-7/8"x23-1/2"x17-1/8")
Net Weight	34.2kg (75.4lbs)
Power Supply Cord	2.5m (8.2ft)

Tool does not come with saw blade



Socket Wrench, Vise Assembly, Dust Bag, Holder Set

LH1201FL 305mm (12") Table Top Miter Saw

Max. cutting width up to 200mm

JM29000123



Continuous Rating Input	1,650W
Blade Diameter	305 mm (12")
Miter Angle	47° L / 52° R
Bevel Angle	45° L
Max Cutting Capacity	90°: 62x200mm (2-7/16"x7-7/8") 90°: 95x155mm (3-3/4"x6-1/8") 45° Miter, L/R: 62x135mm (2-7/16"x5-1/16") 45° Miter, L/R: 95x110mm (3-3/4"x4-5/16") 90°, Table saw: 52mm (2-1/16")
No Load Speed (RPM)	3,800
Sound Power Level	106 dB(A)
Table Size (W x L)	307 x 465 mm (12-1/8" x 18-1/4")
Net Weight	20.9 kg (46.1 lbs)
Power Supply Cord	2.5 m (8.2 ft)



Carbide-tipped saw blade, Vertical vise, Dust bag, Guide rule, Ring, Triangular rule, Push stick, Blade cover, Socket wrench, Holder set

MLT100 260mm (10-1/4") Table Saw

Sliding left extension sub-table is provided

JM23000123



JM27000300



Continuous Rating Input	1,500W
Max Cutting Capacity	0°: 93 mm (3-5/8") 45°: 64 mm (2-1/2")
Blade Diameter	260 mm (10-1/4")
No Load Speed (RPM)	4,300
Dimensions (L x W x H)	726x984x333mm (28-1/2"x38-3/4"x13-1/8")
Net Weight	34.1kg (75.2lbs)
Power Supply Cord	2.5m (8.2ft)

*Comes with JM27000300 (1 unit)



TCT Saw Blade, Rip Fence, Miter Gauge, Wrenches, Push Stick, Triangular Rule

2712 315mm (12-3/8") Table Saw

315mm table saw with induction motor



Max Cutting Capacity	0°: 85 mm (3-3/8") 45°: 58 mm (2-1/4")
Blade Diameter	315 mm (12-3/8")
No Load Speed (RPM)	50Hz: 2,950 60Hz: 3,400
Bevel Cutting Capacity	0 - 45
Dimensions (L x W x H)	1,670x700x810mm (65-3/4"x27-1/2"x32")
Net Weight	54kg (118.9lbs)
Power Supply Cord	3.0m (9.8ft)



Tct Saw Blade, Rip Fence, Miter Gauge, Wrenches, Push Stick, Ring

SJ401 Scroll Saw

Bevel cuts up to 45 degrees to the left and 15 degrees to the right

375009-001



Continuous Rating Input	50W
Capacity	Thickness of cut: 50mm (2") Throat: 406mm (16")
Length of Stroke	18 mm (11/16")
Strokes Per Minute (SPM)	400-1,600
Overall Length	600 mm (23-5/8")
Net Weight	14.1kg (31lbs)



Saw Blades 6, Hex Wrench, Blade Change Rod

LB1200F 305mm (12") Band Saw

305mm Band Saw with high cutting efficiency



Continuous Rating Input	900W
Capacity	Thickness of cut: 165mm (6-1/2") Throat: 305mm (12")
Blade Speed High	(50Hz)800 (60Hz)1,000m (50Hz)2,624 (60Hz) 3,280ft / min
Blade Speed Low	(50Hz)400 (60Hz)500m (50Hz)1,312 (60Hz) 1,640ft / min
Dimensions (L x W x H)	615x775x1,600mm (24-1/4"x30-1/2"x63")
Net Weight	82kg (181.2lbs)
Power Supply Cord	2.5m (8.2ft)



Saw Blades 6, Hex Wrench, Blade Change Rod

CIRCULAR SAW

PRODUCTS



SP001GZ 165mm (6-1/2") Cordless Plunge Cut Saw

BL motor delivers 4,900 RPM for fast cutting and ripping

Li-ion Ah 8.0 | 5.0 | 4.0 | 2.5 | 2.0



Blade Diameter	165 mm (6-1/2")
Max Cutting Capacity	0°: 56 mm (2-3/16") 45°: 40 mm (1-9/16") 48°: 38 mm (1-1/2")
No Load Speed (RPM)	2,500 - 4,900
Sound Power Level	100 dB(A)
Dimensions (L x W x H)	347 x 221 x 271 mm (13-5/8 x 8-3/4 x 10-5/8")
Net weight	4.4 - 5.0 kg (9.7 - 11.0 lbs.)



TCT Saw Blade, Hex Wrench, Wireless Unit (country-specific), Battery, Charger, Z: Battery and Charger are sold separately

Cutting Performance
40 x 600mm Kitchen board (Laminated wood) cutting, Bevel angle: 0°

150 cuts (with BL4040*)

Photo: SP001G

Max Cutting Capacity **56mm**

DSP600Z 165mm (6-1/2") Cordless Plunge Cut Saw

18V X2 (36V) LXT BL Cordless 165 mm (6-1/2") Plunge Cut Saw

Li-ion Ah 6.0 5.0 3.0 1.5



Blade Diameter	165 mm (6-1/2")
Max Cutting Capacity	90°: 56 mm (2-3/16") 45°: 40 mm (1-9/16") 48°: 38 mm (1-1/2")
No Load Speed (RPM)	2,500 - 6,300
Sound Power Level	103 dB(A)
Dimensions (L x W x H)	346x241x272 mm (13-5/8"x9-1/2"x10-3/4")
Net weight	4.4 - 5.1 kg (9.8 - 11.2 lbs)

18V x2



Blade, Blade Cover, Base Cover, Hex Wrench, Z: Battery and Charger are sold separately

DSP601Z 165mm (6-1/2") Cordless Plunge Cut Saw

18V X2 (36V) LXT BL Cordless 165 mm (6-1/2") Plunge Cut Saw

Li-ion Ah 6.0 5.0 3.0 1.5



Blade Diameter	165 mm (6-1/2")
Max Cutting Capacity	90°: 56 mm (2-3/16") 45°: 40 mm (1-9/16") 48°: 38 mm (1-1/2")
No Load Speed (RPM)	2,500 - 6,300
Sound Power Level	103 dB(A)
Dimensions (L x W x H)	346x241x272 mm (13-5/8"x9-1/2"x10-3/4")
Net weight	4.4 - 5.1 kg (9.8 - 11.2 lbs)

18V x2



Blade, Blade Cover, Base Cover, Hex Wrench, Z: Battery and Charger are sold separately

SP6000J 165mm (6-1/2") Plunge Cut Circular Saw

Light duty model with continuous input 450W

303 mm



Continuous Rating Input	1,300W
Blade Diameter	165 mm (6-1/2")
Max Cutting Capacity	90°: 56 mm (2-3/16") 45°: 40 mm (1-9/16") 48°: 38 mm (1-1/2")
No Load Speed (RPM)	2,200 - 6,400
Dimensions (L x W x H)	341x225x250mm (13-3/8"x8-7/8"x9-7/8")
Net Weight	4.1kg (9lbs)
Power Supply Cord	2.5m (8.2ft)



Carbide-tipped saw blade. Hex wrench

HS009GZ 235mm (9-1/4") Cordless Circular Saw

40Vmax XGT BL AWS Cordless 235 mm (9-1/4") Magnesium Circular Saw

Li-ion Ah 8.0 5.0 4.0 2.5 2.0



Wheel Diameter	235 mm (9-1/4")
Hole Diameter	15.88 / 25 / 25.4 / 30 mm (5/8" / 1" / 1-3/16")
Blade Body Thickness	1.4 - 1.8 mm
Max Cutting Capacity	0°: 85 mm (3-3/8") 45°: 61 mm (2-3/8") 60°: 44 mm (1-3/4")
No Load Speed (RPM)	4,000
Max Output	1,600 W
Dimensions (L x W x H)	413 x 196 x 316 mm (16-1/4 x 7-3/4 x 12-1/2")
Net weight	5.1 - 5.7 kg (11.2 - 12.6 lbs.)

40Vmax



TCT Saw Blade, Sub Base, Hex Wrench, Battery, Charger, Z: Battery and Charger are sold separately



Photo: HS009G

Lightweight & high power

Predecessor AC Model **6.7 kg**

HS009G/ HS010G **5.7/ 6.1 kg** (with BL4050F)

Magnesium diecast base (HS009G only) having direct compatibility with Guide rail

Twin LED Job light

Bevel cuts up to 1° left and 60° right.

60°

Work amount on a single full battery charge

120 cuts

Model: HS009G
Oak wood (Thickness: 80mm / Width: 300mm / Bevel angle: 0°) with BL4050F



HS010GZ 235mm (9-1/4") Cordless Circular Saw

40Vmax XGT BL AWS Cordless 235 mm (9-1/4") Circular Saw

Li-ion Ah 8.0 5.0 4.0 2.5 2.0



Wheel Diameter	235 mm (9-1/4")
Hole Diameter	25 / 25.4 / 30 mm (1" / 1-3/16")
Blade Body Thickness	1.4 - 1.8 mm
Max Cutting Capacity	0°: 85 mm (3-3/8") 45°: 61 mm (2-3/8") 60°: 41 mm (1-5/8")
No Load Speed (RPM)	4,000
Max Output	1,600 W
Dimensions (L x W x H)	430 x 224 x 316 mm (17 x 8-7/8 x 12-1/2")
Net weight	5.5 - 6.1 kg (12.1 - 13.4 lbs.)

40Vmax



TCT Saw Blade, Guide Rule, Hex Wrench, Battery, Charger, Z: Battery and Charger are sold separately



HS003GM201 (RM2) / GZ
190mm / 185mm (7-1/2" / 7-1/4") Cordless Circular Saw

BL motor delivers 6,000 RPM for fast cutting

Li-ion Ah 8.0 5.0 4.0 2.5 2.0



HS003GM201 / GZ
1

Blade Diameter	190 / 185 mm (7-1/2" / 7-1/4")
Max Cutting Capacity	90°: 68.5 / 66 mm (2-11/16" / 2-5/8") 45°: 47.5 / 45.5 mm (1-7/8" / 1-13/16") 56°: 35.5 / 34 mm (1-3/8" / 1-5/16")
No Load Speed (RPM)	6,000
Dimensions (L x W x H)	w/ BL4025: 316x200x290 mm (12-1/2"x7-7/8"x11-3/8") w/ BL4040: 331x200x290 mm (13"x7-7/8"x11-3/8")
Net weight	4.1 - 4.4 kg (9.0 - 9.7 lbs.)

40Vmax



XGT BL AWS ADT XPT

TCT Saw Blade, Dust Nozzle, Hex Wrench, Battery, Charger, Z: Battery and Charger are sold separately

HS004GM201 (RM2) / GZ
190mm / 185mm (7-1/2" / 7-1/4") Cordless Circular Saw

BL motor delivers 6,000 RPM for fast cutting

Li-ion Ah 8.0 5.0 4.0 2.5 2.0



HS004GM201 / GZ
1

Blade Diameter	190 / 185 mm (7-1/2" / 7-1/4")
Max Cutting Capacity	90°: 62.5 / 60 mm (2-7/16" / 2-3/8") 45°: 44.5 / 43 mm (1-3/4" / 1-11/16") 48°: 42 / 41 mm (1-5/8" / 1-5/8")
No Load Speed (RPM)	6,000
Dimensions (L x W x H)	w/ BL4025: 322x210x290 mm (12-5/8"x8-1/4"x11-3/8") w/ BL4040: 337x210x290 mm (13-1/4"x8-1/4"x11-3/8")
Net weight	4.4 - 4.7 kg (9.7 - 10.4 lbs.)

40Vmax



XGT BL AWS ADT XPT

TCT Saw Blade, Dust Nozzle, Hex Wrench, Guide Rule, Battery, Charger, Z: Battery and Charger are sold separately

HS012GZ 165mm (6-1/2") Cordless Circular Saw

40Vmax XGT BL AWS Cordless Circular Saw, Electric Brake, Soft Start, Twin LED Light

Li-ion Ah 8.0 5.0 4.0 2.5 2.0



Wheel Diameter	165 mm (6-1/2")
Hole Diameter	20 mm (13/16")
Max Cutting Capacity	0°: 57 mm (2-1/4") 45°: 41 mm (1-5/8")
No Load Speed (RPM)	5,200
Dimensions (L x W x H)	w/ BL4020 / BL4025: 352 x 157 x 246 mm (13-7/8 x 6-3/16 x 9-11/16") w/ BL4040: 359 x 157 x 246 mm (14-9/64 x 6-3/16 x 9-11/16") w/ BL4080F: 406 x 157 x 246 mm (15-63/64 x 6-3/16 x 9-11/16")
Net weight	3.2 - 4.4 kg (7.1 - 9.7 lbs.)

40Vmax



XGT BL AWS ADT XPT

TCT saw blade, Guide rule, Dust nozzle, Hex wrench, Battery, Charger, Z: Battery and Charger are sold separately



DHS900Z 235mm (9-1/4") Cordless Circular Saw

Magnesium Circular Saw, Electric Brake, Soft Start, Twin LED Light

Li-ion Ah 6.0 5.0 3.0 1.5



Blade Diameter	235 mm (9-1/4")
Max Cutting Capacity	90°: 85 mm (3-3/8") 45°: 61 mm (2-3/8") 60°: 44 mm (1-3/4")
No Load Speed (RPM)	6,000
Dimensions (L x W x H)	413x196x316 mm (16-1/4"x7-3/4"x12-1/2")
Net weight	5.3 - 6.0 kg (11.7 - 13.2 lbs.)

18V x2



XGT BL AWS ADT XPT

Wireless Unit (country-specific), TCT Saw Blade, Sub Base, Hex Wrench, Battery, Charger, Z: Battery and Charger are sold separately

DHS710Z 190mm / 185mm (7-1/2" / 7-1/4") Cordless Circular Saw

Makita-built motor delivers 4,800 RPM for fast cutting and ripping

442 mm

Li-ion Ah 6.0 5.0 3.0 1.5



Blade Diameter	190 / 185 mm (7-1/2" / 7-1/4")
Max Cutting Capacity	90°: 68.5 / 66 mm (2-11/16" / 2-5/8") 45°: 49 / 47.5 mm (1-15/16" / 1-7/8") 50°: 44 / 42.5 mm (1-3/4" / 1-11/16")
No Load Speed (RPM)	4,800
Dimensions (L x W x H)	356 x 217 x 298 mm (14 x 8-1/2 x 11-3/4")
Net weight	3.9 - 4.6 kg (8.6 - 10.1 lbs.)

18V x2



XGT

TCT Saw Blade, Rip Fence (Guide Rule), Hex Wrench, Dust Nozzle (country-specific), Battery, Charger, Z: Battery and Charger are sold separately

DHS661RGJ / Z 165mm (6-1/2") Cordless Circular Saw

Compact and Lightweight

Li-ion Ah 6.0 5.0 3.0 1.5



DHS661RGJ
1
DHS661Z
2

Blade Diameter	165 mm (6-1/2")
Hole Diameter	15.88 / 20 mm (5/8" / 13/16")
Max Cutting Capacity	90°: 57 mm (2-1/4"), 45°: 41 mm (1-5/8") 50°: 37 mm (1-7/16")
No Load Speed (RPM)	5,000
Sound Power Level	104 dB(A)
Dimensions (L x W x H)	270x186x250 mm (10-5/8"x7-3/8"x9-7/8")
Net weight	2.9 - 3.2 kg

18V



XGT BL AWS ADT XPT

TCT Saw Blade, Hex Wrench, Rip Fence (Guide Rule), Dust Nozzle, Battery, Fast Charger, Z: Battery and Charger are sold separately

DHS660Z 165mm (6-1/2") Cordless Circular Saw

Compact and Lightweight

Li-ion Ah 6.0 5.0 3.0 1.5



Blade Diameter	165 mm (6-1/2")
Hole Diameter	15.88 / 20 mm (5/8" / 13/16")
Max Cutting Capacity	90°: 57 mm (2-1/4"), 45°: 41 mm (1-5/8") 50°: 37 mm (1-7/16")
No Load Speed (RPM)	5,000
Sound Power Level	104 dB(A)
Dimensions (L x W x H)	270x186x250 mm (10-5/8"x7-3/8"x9-7/8")
Net weight	2.9 - 3.2 kg (6.3 - 7.0 lbs.)

18V



XGT BL AWS ADT XPT

TCT Saw Blade, Hex Wrench, Rip Fence (Guide Rule), Dust Nozzle, Battery, Fast Charger, Z: Battery and Charger are sold separately

DSS610RTE / Z 165mm (6-1/2") Cordless Circular Saw

Lightweight and compact design

441

Li-ion Ah 6.0 5.0 3.0 1.5



Blade Diameter	165 mm (6-1/2")
Max Cutting Capacity	90°: 0-57 mm (2-1/4") 45°: 0-40 mm (1-9/16") 50°: 0-36 mm (1-7/16")
No Load Speed (RPM)	3,700
Dimensions (L x W x H)	347x202x228 mm (13-5/8"x8"x9")
Net weight	3.0 - 3.4 kg (6.7 - 7.5 lbs)

DSS610RTE

DSS610Z

18V



Fast Charger, Battery Cartridge, Carbide-tipped Saw Blade, Guide Rule, Hex Wrench, Z: Battery and Charger are sold separately

DSS501RTE / Z 136mm (5-3/8") Cordless Circular Saw

Well balanced tool design for high maneuverability

430

Li-ion Ah 6.0 5.0 3.0 1.5



Blade Diameter	136 mm (5-3/8")
Max Cutting Capacity	90°: 51 mm (2") 45°: 35 mm (1-3/8")
No Load Speed (RPM)	3,600
Dimensions (L x W x H)	364x183x201 mm (14-3/8"x7-1/4"x7-7/8")
Net weight	2.4 - 2.7 kg (5.3 - 6.0 lbs)

18V



Fast Charger, Battery Cartridge, Carbide-tipped Saw Blade, Guide Rule, Hex Wrench, Z: Battery and Charger are sold separately

HS301DWAE / DZ 85mm (3-3/8") Cordless Circular Saw

High power, high cutting efficiency

Li-ion Ah 5.0 4.0 2.0 1.5



Blade Diameter	85 mm (3-3/8")
Max Cutting Capacity	90°: 25.5 mm (1") 45°: 16.5 mm (5/8")
No Load Speed (RPM)	1,500
Max Output	160W
Dimensions (L x W x H)	313x170x155mm (12-3/8"x6-11/16"x6-1/8")
Net Weight	1.6 - 1.7kg (3.5 - 3.8lbs)

HS301DWAE

HS301DZ

12Vmax



TCT saw blade, Hex wrench, Battery, Charger, DZ: Battery and Charger are sold separately

HS300DW / DZ 85mm (3-3/8") Cordless Circular Saw

Lightweight and Compact design

Li-ion Ah 1.3



Blade Diameter	85 mm (3-3/8")
Max Cutting Capacity	90°: 25.5 mm (1") 45°: 16.5 mm (5/8")
No Load Speed (RPM)	1,400
Dimensions (L x W x H)	300x170x154mm (11-3/4"x6-11/16"x6-1/16")
Net Weight	1.5 kg (3.3 lbs)

10.8V



Charger, Battery Cartridge, T.C.T Saw Blade, Hex Wrench, DZ: Battery and Charger are sold separately

HS6600 165mm (6-1/2") Circular Saw

Powerful 1,050 W motor delivers 5,200 RPM for performance

303



Continuous rating Input	1,050W
Blade Diameter	165 mm (6-1/2")
Hole Diameter	15.88, 20, 25.4, 30 mm (5/8, 13/16, 1, 1-3/16")
Max Cutting Capacity	0°: 54.5 mm (2-1/8") 45°: 37.5 mm (1-1/2")
No Load Speed (RPM)	5,200
Dimensions (L x W x H)	296 x 230 x 243 mm (11-5/8" x 9" x 9-9/16")
Net weight	3.5 kg (7.6 lbs.)
Power supply cord	2.5 m (8.2 ft)



Rip Fence (Guide Rule), TCT Saw Blade, Hex Wrench

5806B 185mm (7-1/4") Circular Saw

Sawdust and chips hardly ever come near operator

303



Continuous Rating Input	1,050W
Blade Diameter	185 mm (7-1/4")
Max Cutting Capacity	90°: 66 mm (2-5/8") 45°: 44 mm (1-11/16")
No Load Speed (RPM)	5,200
Overall Length	282 mm (11-1/8")
Net Weight	3.5kg (7.6lbs)
Power Supply Cord	2.5m (8.2ft)



Carbide-Tipped Saw Blade, Hex Wrench, Rip Fence (Guide Rule)

HS7600 185mm (7-1/4") Circular Saw

New aesthetic design with Soft grip

303



Continuous Rating Input	1,200W
Blade Diameter	185 mm (7-1/4")
Max Cutting Capacity	90°: 64 mm (2-1/2") 45°: 42 mm (1-5/8")
No Load Speed (RPM)	5,200
Vibration Level	Cutting Wood: 2.5 m/s ² or less
Sound Power Level	98 dB(A)
Dimensions (L x W x H)	309x234x255mm (12-1/8"x9-1/4"x10-1/4")
Net Weight	3.8 kg (8.3 lbs)
Power Supply Cord	2.5 m (8.2 ft)



TCT Saw Blade, Hex wrench, Rip fence (guide rule)

HS7010 185mm / 190mm (7-1/2" / 7-1/4") Circular Saw

185 mm (7-1/4") / 190 mm (7-1/2") 1,600 W Circular Saw

303



Continuous Rating Input	1,600W
Blade Diameter	185 / 190 mm (7-1/4" / 7-1/2")
Max Cutting Capacity	90°: 65 / 67 mm (2-9/16" / 2-5/8") 45°: 44 / 45 mm (1-3/4" / 1-3/4")
No Load Speed (RPM)	5,500
Dimensions (L x W x H)	300x240x261 mm (11-3/4"x9-1/2"x10-1/4")
Net Weight	4.0 kg (8.9 lbs)
Power Supply Cord	2.5 m (8.2 ft)



TCT Saw Blade, Rip Fence (Guide Rule), Hex Wrench, Dust Nozzle (country-specific)

5008MG 210mm (8-1/4") Circular Saw

Maximum cutting depth of 75.5mm (3")



Continuous Rating Input	1,800W
Blade Diameter	210 mm (8-1/4")
Max Cutting Capacity	90°: 75.5 mm (3") 45°: 57 mm (2-1/4") 50°: 51.5 mm (2")
No Load Speed (RPM)	5,200
Dimensions (L x W x H)	332x243x277mm (13-1/8"x9-9/16"x10-7/8")
Net Weight	4.8kg (10.6lbs)
Power Supply Cord	2.5m (8.2ft)



TCT Saw Blade, Hex Wrench, Rip Fence (Guide Rule)

N5900B 235mm (9-1/4") Circular Saw

Bevel cuts up to 50 degrees



Continuous Rating Input	2,000W
Blade Diameter	235 mm (9-1/4")
Max Cutting Capacity	90°: 85 mm (3-3/8") 45°: 60 mm (2-3/8") 50°: 53 mm (2-1/16")
No Load Speed (RPM)	4,100
Overall Length	380 mm (15")
Net Weight	6.8kg (14.8lbs)
Power Supply Cord	2.5m (8.2ft)



T. C. T Saw Blade, Grip, Wrench & Rip Fence

HS0600 270mm / 260mm (10-5/8" / 10-1/4") Circular Saw

270 mm (10-5/8") 2,000 W Circular Saw



Continuous Rating Input	2,000W
Blade Diameter	260 - 270 mm (10-1/4" - 10-5/8")
Max Cutting Capacity	90°: 97 mm (3-13/16") 45°: 68 mm (2-11/16")
No Load Speed (RPM)	4,300
Sound Power Level	105 dB(A)
Dimensions (L x W x H)	418x273x324 mm (16-1/2"x10-3/4"x12-3/4")
Net Weight	6.9 kg (15.2 lbs)
Power Supply Cord	2.5 m (8.2 ft)



TCT Saw Blade, Hex Wrench, Rip Fence (Guide Rule)

5103N 335mm (13-1/8") Circular Saw

Huge cutting capacity with efficient control



Continuous Rating Input	1,750W
Blade Diameter	335 mm (13-1/8")
Max Cutting Capacity	90°: 128 mm (5") 45°: 91 mm (3-5/8")
No Load Speed (RPM)	2,900
Overall Length	505 mm (19-7/8")
Net Weight	8.9kg (19.6lbs)
Power Supply Cord	5.0m (16.4ft)



Combination Saw Blade, Wrench, Hex Wrench, Rip Fence (Guide Rule)

JIG SAW

PRODUCTS



JV002GM201(RM2J) / GZ Cordless Jig Saw

New

Top Handle Jig Saw, 3 Orbital Settings plus Straight Cutting, Twin LED Lights

Li-ion Ah 8.0 | 5.0 | 4.0 | 2.5 | 2.0



Capacity	Wood: 135 mm (5-5/16") Mild Steel: 10 mm (3/8") Aluminum: 20 mm (25/32")
Stroke length	26 mm (1")
Strokes per minute (SPM)	0 - 3,500
Bevel range	0 - 45°
Vibration level	4.2m/s ²
Work mode:	cutting sheet metal
Dimensions (L x W x H)	w/ BL4025: 272 x 84 x 208 mm (10-3/4 x 3-5/16 x 8-3/16")
Net weight	2.7 - 3.0 kg (6.0 - 6.6 lbs.)

40Vmax



Jig saw blade, Cover plate, Dust nozzle (country-specific), Kert board, Hex wrench, Battery, Charger, Z: Battery and Charger are sold separately

Cutting speed 20% up
Compared to predecessor 18V model

BL MOTOR

DJV182RTE / Z Cordless Jig Saw

Top handle type cordless jig saw powered by Li-ion batteries

Li-ion Ah 6.0 | 5.0 | 3.0 | 1.5



Capacity	Wood: 135 mm (5-5/16") Steel: 10 mm (3/8")
Length of Stroke	26 mm (1")
Strokes Per Minute (SPM)	800 - 3,500
Dimensions (L x W x H)	266x77x208 mm (10-1/2"x3"x8-3/16")
Net weight	2.4 - 2.7 kg (5.2 - 5.9 lbs)

Cutting capacity in wood: when cutting with optional blade No.B-16L



18V



Fast Charger, Battery Cartridge, Jig Saw Blade Assortment, Cover Plate, Anti-splintering Device, Hex Wrench, Z: Battery and Charger are sold separately



DJV184RTJ / Z Cordless Jig Saw

3 Orbital Settings Plus Straight Cutting, LED Light

Li-ion Ah 6.0 | 5.0 | 3.0 | 1.5



Capacity	Wood: 135 mm (5-5/16") Steel: 10 mm (3/8") Aluminum: 20 mm (25/32")
Length of Stroke	23 mm (7/8")
Strokes Per Minute (SPM)	0 - 3,000
Dimensions (L x W x H)	259 x 78 x 205 mm (10-1/4 x 3-1/16 x 8-1/8")
Net weight	2.1 - 2.5 kg (4.6 - 5.5 lbs.)

18V



Jig Saw Blade, Hex Wrench, Cover Plate, Dust Nozzle (country-specific), Dust Cover (country-specific), Battery, Charger, Z: Battery and Charger are sold separately

JV103DSAJ / DZ Cordless Jig Saw

Disabling soft no-load rotation function in operator's preference

Li-ion Ah 5.0 | 4.0 | 2.0 | 1.5



Max Cutting Capacity at 90°	Wood: 90mm (3-1/2") Aluminum: 20mm (13/16") Mild Steel: 10mm (3/8")
Length of Stroke	23 mm (7/8")
Strokes Per Minute (SPM)	800 - 3,000
Sound Power Level	96 dB(A)
Dimensions (L x W x H)	237x76x206 mm (9-3/8"x3"x8-1/8")
Net Weight	1.9 - 2.0 kg (4.1 - 4.4 lbs)



12Vmax



Jig Saw Blade, Hex Wrench, Cover Plate (country-specific), Dust Nozzle (country-specific), Dust Cover (country-specific), Battery, Charger, DZ: Battery and Charger are sold separately



JV101DSAE / DZ Cordless Jig Saw

12Vmax CXT Li-Ion Cordless Top Handle Jig Saw

Li-ion Ah 5.0 | 4.0 | 2.0 | 1.5



Max Cutting Capacity at 90°	Wood: 65mm (2-9/16") Aluminum: 4mm (5/32") Mild Steel: 2mm (1/16")
Length of Stroke	18 mm (11/16")
Strokes Per Minute (SPM)	0-2,900
Sound Power Level	91 dB(A)
Dimensions (L x W x H)	232x76x196mm (9-1/8"x3"x7-3/4")
Net Weight	1.8 - 1.9kg (3.9 - 4.3lbs)



12Vmax



Jig Saw Blade, Hex Wrench, Guide Rule (country-specific), Battery, Charger, DZ: Battery and Charger are sold separately

4327M Jig Saw

High power and Lightweight

64



Continuous Rating Input	450W
Capacity	Wood: 40 mm (1-9/16") Steel: 6 mm (1/4")
Length of Stroke	18 mm (11/16")
Strokes Per Minute (SPM)	500 - 3,100
Dimensions (L x W x H)	224x77x197mm (8-7/8"x3"x7-3/4")
Net Weight	1.8 kg (4.0 lbs.)
Power Supply Cord	2.0m (6.6ft)



Jig Saw Blade, Hex Wrench

JV0600K Jig Saw

Powerful and Maneuverable

64



Continuous Rating Input	650W
Capacity	Wood: 90 mm (3-1/2") Steel: 10 mm (3/8")
Length of Stroke	23 mm (7/8")
Strokes Per Minute (SPM)	500 - 3,100
Dimensions (L x W x H)	236x77x199mm (9-1/4"x3"x7-7/8")
Net Weight	2.4kg (5.2lbs)
Power Supply Cord	2.5m (8.2ft)



Jig Saw Blade, Hex Wrench

PLANING & ROUTERING

PRODUCTS



KP001GZ 82mm (3-1/4") Cordless Planer

40Vmax XGT BL AWS ADT Cordless 82 mm (3-1/4") Planer

Li-ion Ah 8.0 | 5.0 | 4.0 | 2.5 | 2.0



Planing Width	82 mm (3-1/4")
Planing Depth	4 mm (5/32")
Shiplapping	25 mm (1")
No Load Speed (RPM)	15,000
Dimensions (L x W x H)	379 x 156 x 166 mm (14-7/8 x 6-1/8 x 6-1/2")
Net weight	3.8 - 4.4 kg (8.3 - 9.6 lbs.)

40Vmax



Planer Blade, Blade Gauge, Guide Rule, Depth Guide, Socket Wrench, Sharpening Holder Assembly (for resharpenable blade), Wireless Unit (country-specific), Battery, Charger, Z: Battery and Charger are sold separately

Photo: KP001G



connects to compatible vacuum cleaners via Bluetooth.



DKP181Z 82mm (3-1/4") Cordless Planer

High power BL motor delivers powerful cutting

Li-ion Ah 6.0 | 5.0 | 3.0 | 1.5



Planing Width	82 mm (3-1/4")
Planing Depth	3 mm (1/8")
Max Shiplapping	25mm (1")
No Load Speed (RPM)	12,000
Dimensions (L x W x H)	366x156x166 mm (14-3/8"x6-1/8"x6-1/2")
Net weight	3.3 - 3.6 kg (7.3 - 7.9 lbs.)

18V



Planer Blade, Blade Gauge, Guide Rule, Socket Wrench, Dust Nozzle, Z: Battery and Charger are sold separately

KP0800X 82mm (3-1/4") Power Planer

Angle and shape of handle are easy to grip, push and carry

411 W



Continuous Rating Input	620W
Planing Width	82 mm (3-1/4")
Planing Depth	2.5 mm (3/32")
No Load Speed (RPM)	17,000
Dimensions (L x W x H)	285x158x158mm (11-1/4"x6-1/4"x6-1/4")
Net Weight	2.8 kg (6.2 lbs)
Power Supply Cord	2.5 m (8.2 ft)



Blade Gauge Assembly, Guide Rule, Planer Blade, Socket Wrench, Sharpening Holder, Shiplapping: 9 mm (11/32")

1911B 110mm (4-3/8") Power Planer

Planes up to 110mm (4-3/8") wide and 2mm (1/16") deep in a single pass

106 W



Continuous Rating Input	840W
Planing Width	110 mm (4-3/8")
Planing Depth	2 mm (1/16")
No Load Speed (RPM)	16,000
Overall Length	355 mm (14")
Net Weight	4.3kg (9.5lbs)
Power Supply Cord	5.0m (16.4ft)



Sharpening Holder Assembly, Blade Gauge Assembly, Socket Wrench, Planer Blade

1805N 155mm (6-1/8") Power Planer

Rugged aluminum housing and easy depth settings

153 W



Continuous Rating Input	1,140W
Planing Width	155 mm (6-1/8")
Planing Depth	2 mm (1/16")
No Load Speed (RPM)	15,000
Overall Length	445 mm (17-1/2")
Net Weight	7.9kg (17.3lbs)
Power Supply Cord	5.0m (16.4ft)



Sharpening Holder Assembly, Blade Gauge Assembly, Socket Wrench, Planer Blade

2012NB 304mm (12") Power Planer

Compact and lightweight for easier transport

153 mm



Continuous Rating Input	1,650W
Cutting Width	304 mm (12")
Cutting Depth	Cutting width 0-150mm: 3mm (1/8") Cutting width 150-240mm: 1.5mm (1/16")
Feed Rate/min.	8.5m (27.9ft)
Table Size (W x L)	304 x 771 mm (12" x 30-3/8")
No Load Speed (RPM)	8,500
Dimensions (L x W x H)	483x771x401mm (19"x30-3/8"x15-13/16")
Net Weight	28.1kg (61.9lbs)
Power Supply Cord	2.5m (8.2ft)



Socket Wrench, Hex Wrench, Magnetic Holders X 2, Planer Blade 306

DPJ180Z Cordless Plate Joiner

New top handle with flat shape on side surface for excellent tool control

430 mm



Li-ion Ah 6.0 5.0 3.0 1.5

Blade Diameter	100 mm (4")
Max cutting depth	20 mm (3/4")
No Load Speed (RPM)	6,500
Dimensions (L x W x H)	351x139x149 mm (13-3/4"x5-1/2"x5-7/8")
Net weight	2.8 - 3.1 kg (6.2 - 6.8 lbs)

18V



3

Cutter Blade, Angle Guide, Lock Nut Wrench, Set Plate, Dust Bag, Z: Battery and Charger are sold separately

PJ7000 Plate Joiner

Cast aluminum pivot fence with three positive stops at 0°, 45° and 90°

459 mm



Continuous Rating Input	701W
Blade Diameter	100 mm (4")
No Load Speed (RPM)	11,000
Dimensions (L x W x H)	302x139x145mm (11-7/8"x5-1/2"x5-3/4")
Net Weight	2.8kg (6.2lbs)
Power Supply Cord	2.5m (8.2ft)



Cutter Blade, Angle Guide, Dust Bag, Set Plate, Lock Nut Wrench

DCO181Z 6.35mm (1/4") Cordless Cut-Out Tool

High power delivered by BL motor

Li-ion Ah 6.0 5.0 3.0 1.5



Collet Capacity	3 mm, 6 mm or 1/8", 1/4"
No load speed (rpm)	32,000
Max Output	600W
Circumference of Grip Portion	210 mm (8-1/4")
Dimensions (L x W x H)	w/ BL1815N: 293x79x117 mm (11-1/2"x3-1/8"x4-5/8") w/ BL1830B / BL1850B / BL1860B: 311x79x117 mm (12-1/4"x3-1/8"x4-5/8")
Net weight	1.4 - 1.7 kg (3.1 - 3.7 lbs.)

18V



Drywall Guide Bit, Collet Cone, Dust Collection Cover, Wrench, Battery, Charger, Z: Battery and Charger are sold separately

**RT001GM202(RM2J) / GZ04
6mm (1/4"), 8mm (3/8") Cordless Trimmer**

Compatible with the bases used for DRT50

Li-ion Ah 5.0 4.0 2.5 2.0



Collet Capacity	6, 8 mm or 1/4 - 3/8"
No Load Speed (RPM)	10,000 - 31,000
Plunge Capacity	w/ Trimmer Base: 0 - 40 mm (0 - 1-9/16") w/ Plunge Base: 0 - 35 mm (0 - 1-3/8")
Dimensions (L x W x H)	w/ BL4020 / BL4025: 126 x 89 x 245 mm (5 x 3-1/2 x 9-5/8") w/ BL4040: 141 x 89 x 261 mm (5-9/16 x 3-1/2 x 9-7/8")
Net weight	2.2 - 2.5 kg (4.9 - 5.5 lbs.)

40Vmax



Collet Cone, Trimmer Base Assembly, Straight Guide Assembly, Templet Guide (country-specific), Wrench, Trimmer Guide (country-specific), Dust Nozzle, Tilt Base Assembly (country-specific), Offset Base Assembly (country-specific), Plunge Base Assembly (country-specific), Battery, Charger

DRT50Z 6mm (1/4"), 8mm (3/8") Cordless Trimmer

Cordless for easy maneuverability and 4 different bases for added versatility

Li-ion Ah 6.0 5.0 3.0 1.5



Collet Capacity	6, 8 mm or 1/4, 3/8"
No Load Speed (RPM)	10,000 - 30,000
Plunge Capacity	w/ Trimmer Base: 0 - 40 mm (0 - 1-9/16") w/ Plunge Base: 0 - 35 mm (0 - 1-3/8")
Dimensions (L x W x H)	w/ BL1815N / BL1820B: 134 x 89 x 208 (5-1/4 x 3-1/2 x 8-1/8) w/ BL1830B / BL1850B / BL1860B: 134 x 89 x 226 mm (5-1/4 x 3-1/2 x 8-7/8")
Net weight	1.8 - 2.1 kg (3.9 - 4.6 lbs.)

18V



Collet Cone, Trimmer Base Assembly, Straight Guide Assembly, Templet Guide, Wrench x2, Trimmer Guide, Battery, Fast Charger, Z: Battery and Charger are sold separately

Photo: RT001G



BL motor delivers the power and performance for corded demands

Easy-to-Customize



DRT52Z 6mm (1/4") Cordless Trimmer

New

18V LXT BL Brushless Cordless 6 mm (1/4") Trimmer

Li-ion Ah 6.0 | 5.0 | 3.0 | 1.5



Collet Capacity	6 mm (1/4")
No Load Speed (RPM)	30,000 min ⁻¹
Max output	580 W
Dimensions (L x W x H)	w/ BL1830B / BL1850B / BL1860B: 134 x 90 x 220 mm (5-1/4 x 3-1/2 x 8-5/8")
Net weight	1.4 - 1.7 kg (3.1 - 3.7 lbs.)

18V **LXT XPT**

Wrench, Templet guide, Chip deflector, Straight bit, Trimmer guide assembly, Straight guide assembly, Battery, Charger, Z. Battery and Charger are sold separately

RT0700C / CX2 6mm (1/4"), 8mm (3/8") Trimmer

Aluminum housing and base for higher durability and accuracy

411



Continuous Rating Input	710W
Collet Capacity	6mm, 8mm or 1/4"; 3/8"
No Load Speed (RPM)	10,000-30,000
Sound Power Level	93 dB(A)
Dimensions (L x W x H)	89x89x200mm (3-1/2"x3-1/2"x7-7/8")
Net Weight	1.8 - 2.7kg (3.9 - 6.0lbs)
Power Supply Cord	2.5m (8.2ft)

2

Trimmer Base Assembly, Straight Guide, Collect Cone X 2, Wrench X 2, Template Guide X 1

N3701 6mm (1/4") Trimmer

Transparent acrylic base for clear view of trimming area and sight line

51

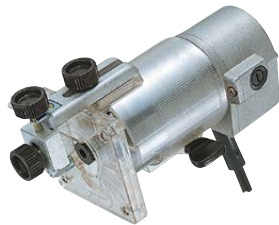

Continuous Rating Input	440W
Collet Capacity	6mm or 1/4"
No Load Speed (RPM)	30,000
Overall Height	181 mm (7-1/8")
Net Weight	1.6kg (3.4lbs)
Power Supply Cord	2.5m (8.2ft)

4

Trimmer Guide Assembly, Straight Guide Assembly, Template Guide, Straight Bit (Carbide-Tipped), Wrench (2pcs.)

3711 6mm (1/4") Trimmer

6 mm (1/4") 530 W Fixed Base Trimmer



Continuous rating Input	530W
Collet Capacity	6 mm or 1/4"
No Load Speed (RPM)	32,000
Plunge Capacity	0 - 42 mm (0 - 1-5/8")
Dimensions (L x W x H)	82 x 90 x 211 mm (3-1/4 x 3-1/2 x 8-5/16")
Net weight	1.5 kg (3.3 lbs.)
Power supply cord	2.5 m (8.2 ft)

1

Collet Cone, Trimmer Guide, Straight Guide Assembly, Templet Guide, Straight Bit, Chip Deflector, Wrench



RP0900 8mm (3/8") Router (Plunge type)

High durability and good design router

106



Continuous Rating Input	900W
Capacity	Collet: 6mm, 8mm or 1/4"; 3/8"
No Load Speed (RPM)	27,000
Sound Power Level	100 dB(A)
Dimensions (L x W x H)	110 x 256 x 217mm (10-3/32"x4-5/16"x8-17/32")
Net Weight	2.7kg (6.0lbs)
Power Supply Cord	2.5m (8.2ft)

2

Straight Guide, Collet Cone, Wrenches

3601B 12mm (1/2") Router

Fine power-to-weight ratio in this well-balanced router

153



Continuous Rating Input	930W
Collet Capacity	12mm or 1/2"
No Load Speed (RPM)	23,000
Overall Height	190 mm (7-1/2")
Net Weight	3.6kg (7.9lbs)
Power Supply Cord	5.0m (16.4ft)

3

Trimmer Guide Assembly, Straight Guide Assembly, Template Guide, Collet Sleeve (6mm or 1/4"), Collet Sleeve (8mm or 3/8"), Wrench (2pcs.), Straight Bit (Carbide-Tipped)

4403 6mm (1/4") Sash Router

Mills and drills aluminum for sashes

411



Continuous Rating Input	530W
Collet Capacity	6 mm or 1/4"
Max Width of Work	123 mm (4-7/8")
Max Width of Work (45°)	77 mm (3")
Max Height of Work	185 mm (7-1/4")
Transverse Travel of Table (Bed)	113 mm (4-1/2")
Longitudinal Travel of Table (Bed)	73 mm (2-7/8")
No Load Speed (RPM)	30,000
Dimensions (L x W x H)	327x350x355 mm (12-7/8"x13-13/16"x14")
Net Weight	16 kg (35.3 lbs)
Power Supply Cord	2.5 m (8.2 ft)

1

Sash Router Bit (Drill Point), Angle Gauge, Wrench X2, Oil Supply, Collet Cone (6mm or 1/4")

SANDING & POLISHER

PRODUCTS



DSL801Z 225mm (8-7/8") Cordless Drywall Sander

Variable Speed Drywall Sander

Li-ion Ah 6.0 5.0 3.0 1.5



Pad diameter	210 mm (8-1/4")
Abrasive Disc Size	225 mm (8-7/8")
No Load Speed (RPM)	1,000 - 1,800
Dimensions (L x W x H)	1,120 - 1,540 x 278 x 273 mm (44 - 60-1/2 x 11 x 10-3/4")
Net weight	4.6 - 5.8 kg (10.1 - 12.8 lbs.)

18V



LXT BL AWS XPT

1

Abrasive Disc, Hex Wrench, Tool Bag, Wireless Unit (country-specific), Wireless Unit Adapter (country-specific), Battery, Charger, Z: Battery and Charger are sold separately

DSL800Z 225mm (8-7/8") Cordless Drywall Sander

Constant speed control for smooth finish

Li-ion Ah 6.0 5.0 3.0 1.5



Pad diameter	210 mm (8-1/4")
Abrasive Disc Size	225 mm (8-7/8")
No Load Speed (RPM)	1,000 - 1,800
Max Output	260 W
Sound Pressure Level	75 dB(A)
Dimensions (L x W x H)	1,100 - 1,520 x 259 x 273 mm (43-1/4" - 59-3/4" x 10-1/4" x 10-3/4")
Net weight	4.5 - 5.7 kg (10.0 - 12.6 lbs.)

18V



LXT BL AWS XPT

1

Abrasive Disc, Hex Wrench, Tool Bag, Wireless Unit (country-specific), Wireless Unit Adapter (country-specific), Battery, Charger, Z: Battery and Charger are sold separately

DPO600RTE / Z 150mm (6") Cordless Random Orbit Polisher

Random Orbit Polisher

Li-ion Ah 6.0 5.0 3.0 1.5



DPO600RTE / Z

Pad Size	150 mm (6")
Orbits Per Minute (OPM)	0 - 6,800
Strokes Per Minute (SPM)	0 - 13,600
No Load Speed (RPM)	0 - 780
Sound Pressure Level	83 dB(A)
Sound Power Level	94 dB(A)
Orbit Diameter	5.5 mm (7/32")
Dimensions (L x W x H)	530 x 148 x 126 mm (20-7/8" x 5-7/8" x 5")
Net Weight	3.1 - 3.6 kg (6.9 - 7.9 lbs.)

18V



LXT BL XPT

1

Side Grip, Hex Wrench, Z: Battery and Charger are sold separately

PO600C 150mm (6") Random Orbit Polisher

Random Orbit Polisher

318 W



Continuous Rating Input	900W
Pad Size	150 mm (6")
Orbits Per Minute (OPM)	0 - 6,800
Strokes Per Minute (SPM)	0 - 13,600
No Load Speed (RPM)	0 - 780
Sound Pressure Level	94 dB(A)
Orbit Diameter	5.5 mm (7/32")
Dimensions (L x W x H)	451 x 148 x 126 mm (17-3/4" x 5-7/8" x 5")
Net Weight	2.8 - 3.0 kg (6.2 - 6.5 lbs.)
Power Supply Cord	4.0 m (13.1 ft)

18V



2

Hex Wrench

BO6050J Random Orbit Sander

Random orbit sander with soft start

326 W



Continuous Rating Input	750W
Pad Diameter	150mm (6")
Abrasive Disc Size	150 mm (6")
Orbits Per Minute (OPM)	1,600 - 6,800
Sanding Strokes Per Minute (SPM)	3,200 - 13,600
Pad Speed in Roto-orbit Mode (rpm)	140 - 600
Orbit Diameter	5.5 mm (7/32")
Dimensions (L x W x H)	330 x 155 x 145 mm (13" x 6-1/8" x 5-3/4")
Net Weight	2.6 kg (5.7 lbs)
Power Supply Cord	2.5m (8.2ft)



1

Abrasive disc, Dust nozzle, Side grip, Pad protector

DBO180Z Cordless Random Orbit Sander

Excellent performance with high orbital speed

Li-ion Ah 6.0 5.0 3.0 1.5



Pad diameter	123 mm (4-7/8")
Abrasive Disc Size	125 mm (5")
Orbits Per Minute (OPM)	7,000/9,500/11,000
Dimensions (L x W x H)	175 x 123 x 153 mm (6-7/8" x 4-7/8" x 6")
Net weight	1.4 - 1.7 kg (3.0 - 3.7 lbs)

18V



3

Dust Bag, Z: Battery and Charger are sold separately

BO5031 Random Orbit Sander

Powerful motor and high durability

419



Continuous Rating Input	300W
Pad Diameter	123mm (4-7/8")
Abrasive Disc Size	125 mm (5")
Orbits Per Minute (OPM)	4,000-12,000
Dimensions (L x W x H)	153x123x153mm (6"x4-7/8"x6")
Net Weight	1.3kg (3.0lbs)
Power Supply Cord	2.0m (6.6ft)



Abrasive Disc, Dust Bag Or Dust Box

PV001GM101(RMX) / GZ Cordless Polisher

40Vmax XGT BL Brushless Cordless 180 mm (7") Polisher

Li-ion Ah 8.0 | 5.0 | 4.0 | 2.5 | 2.0



Capacity	Pad: 180mm
No Load Speed (RPM)	0 - 2,200
Dimensions (L x W x H)	w/ BL4050F: 547 x 198 x 196 mm (21-1/2 x 7-3/4 x 7-3/4")
Net weight	3.1 - 3.8 kg (6.8 - 8.4 lbs.)



Loop Handle / Side Handle, Hex Wrench, Battery, Charger, Z: Battery and Charger are sold separately

9237C 180mm (7") Polisher

Elastomer bumper on gear housing

303



Continuous Rating Input	1,200W
Capacity	Wool Pad: 180mm (7") Wool Bonnet: 180mm (7")
No Load Speed (RPM)	0 - 3,200
Sound Power Level	94 dB(A)
Dimensions (L x W x H)	431x198x187mm (17"x7-3/4"x7-3/8")
Net Weight	3.2 - 3.4kg (7 - 7.5 lbs)
Power Supply Cord	2.5 m (8.2 ft)



Loop Handle Or Side Grip, Accessory Set

PV7000C 180mm (7") Polisher

Quick-Flip speed change for compounding and polishing

303



Continuous Rating Input	900W
Capacity	Pad: 180mm (7") Wool Bonnet: 180mm (7")
No Load Speed (RPM)	600 - 2,100
Overall Length	210 mm (8-1/4")
Net Weight	2.1 kg (4.6 lbs)
Power Supply Cord	2.5 m (8.2 ft)



Side Handle, Pad, Wrench

DPV300RTJ / Z Cordless Sander Polisher

18V LXT BL Cordless Sander Polisher

Li-ion Ah 6.0 | 5.0 | 3.0 | 1.5



Capacity	Polisher: 80 mm (3-1/8") Sander: 50 mm (2")
No Load Speed (RPM)	Polisher: 0 - 2,800 Sander: 0 - 9,500
Dimensions (L x W x H)	w/ BL1830B / BL1850B / BL1860B: 160 x 79 x 256 mm (6-5/16 x 3-1/8 x 10-1/8")
Net weight	1.3 - 1.6 kg (2.9 - 3.5 lbs.)



Side Grip, Pad, Adapter, Wool Pad, Sponge Pad, Z: Battery and Charger are sold separately

Compact and highly efficient high maneuverability and long run time

Photo: DPV300



Head length: 127mm



Toolless pad replacement



High/Low 2-speed selection with variable speed in each range

enables to adjust the speed setting to match user's needs.

- 1: Low (for polishing) 0 - 2,800 min⁻¹
- 2: High (for sanding) 0 - 9,500 min⁻¹



For polishing work

PV301DSAE / DZ Cordless Sander Polisher

12Vmax CXT BL Cordless Sander Polisher

Li-ion Ah 5.0 | 4.0 | 2.0 | 1.5



Capacity	Polisher: 80 mm (3-1/8") Sander: 50 mm (2")
No Load Speed (RPM)	Polisher: 0 - 2,800 Sander: 0 - 9,500
Dimensions (L x W x H)	w/ BL1016/BL1021B: 137 x 67 x 201 mm (5-3/8 x 2-5/8 x 7-7/8")
Net weight	1.1 - 1.2 kg (2.4 - 2.6 lbs.)



Side Grip, Pad, Adapter, Wool Pad, Sponge Pad, DZ: Battery and Charger are sold separately

Long continuous operation time

Polishing performance comparison*

*Tested with normal load of 1.6kg, on a full battery charge

PV301D
18min
(with BL1041B)

DPV300
34min
(with BL1850B)

PC5000C/B 125mm (5") Concrete Planer

Most Suitable for Planing Concrete

253



Lock Nut Wrench, Hex Wrench, Dust Bag Assembly, Brush Set

Continuous Rating Input	1,400W
Wheel Diameter	125 mm (5")
Hole Diameter	22.23mm (7/8")
No Load Speed (RPM)	10,000
Dimensions (L x W x H)	437x235x195mm (17-1/8"x9-1/4"x7-5/8")
Net Weight	4.0kg (8.9lbs)
Power Supply Cord	5.0m (16.4ft)

PC5010C 125mm (5") Concrete Planer

Superior handling in horizontal and overhead applications

318



Lock Nut Wrench

Continuous rating input	1,400W
Wheel Diameter	125 mm (5")
Hole Diameter	22.23 mm (7/8")
No Load Speed (RPM)	4,000 - 9,000
Sound Power Level	96.0 dB(A)
Dimensions (L x W x H)	350x231x179 mm (13-3/4"x9-1/8"x7")
Net weight	2.5 - 3.6 kg (5.5 - 7.9 lbs.)
Power supply cord	4.0 m (13.1 ft)

PK5001C 125 mm (5") Angle Sander

Powerful 1,400 W motor delivers more output and 2,000-6,800 RPM

318



Side Grip, Head Cover, Lock Nut Wrench

Continuous Rating Input	1,400W
Wheel Diameter	125 mm (5")
Capacity	Pad: 115mm (4-1/2")
No Load Speed (RPM)	2,000-6,800
Dimensions (L x W x H)	328x80x126mm (12-7/8"x3-1/8"x5")
Net Weight	2.5kg (5.5lbs)
Power Supply Cord	4.0m (13.1ft)

GV6010 150mm (6") Disc Sander

Powerful 440W motor

64



Abrasive Disc, Plastic Pad, Side Grip, Hex Socket Head Bolt, Washer, Hex Wrench

Continuous Rating Input	440W
Abrasive Disc Size	150 mm (6")
Capacity	Pad: 120mm (4-3/4")
No Load Speed (RPM)	4,500
Dimensions (L x W x H)	200x74x181mm (7-7/8"x2-15/16"x7-1/8")
Net Weight	1.2kg (2.6lbs)
Power Supply Cord	2.5m (8.2ft)

9218SB 180mm (7") Disc Sander

Powerful 570W motor in well-balanced body for fast and steady sanding

100



Abrasive Disc, Rubber Pad, Lock Nut Wrench, Wrench, Side Grip

Continuous Rating Input	570W
Wire Cup Brush	110mm (4-3/8")
Abrasive Disc Size	180 mm (7")
No Load Speed (RPM)	4,500
Overall Length	225 mm (8-7/8")
Net Weight	2.3kg (5.1 lbs)
Power Supply Cord	2.5m (8.2ft)

DBO380RTJ / Z Cordless Finishing Sander

High work efficiency similar to that of B03710

Li-ion Ah 6.0 5.0 3.0 1.5



Pad Size	92 x 185 (3-5/8 x 7-1/4)
Abrasive Paper Size	93 x 228 (3-5/8 x 9)
Sanding Strokes (SPM)	8,000/ 16,000/ 24,000
Orbits Per Minute (OPM)	4,000/ 8,000/ 12,000
Dimensions (L x W x H)	w/ BL1830B / BL1850B / BL1860B: 332 x 92 x 169 mm (13-1/4 x 3-5/8 x 6-5/8")
Net weight	2.2 kg (4.9) lbs.)



Abrasive Paper, Dust Bag / Dust Box, Punch Plate, Z: Battery and Charger are sold separately

Stress-free sanding without cord

Both motor and battery are located above the sanding face to suppress fluttering of the base, enabling to provide an evenly finished surface.



Battery protector
Prevents damage to the battery and work material.



Detachable front grip
Detachable without tools and can be ground close-to-wall.

Easy-to-operate paper clamp
ensures easy installation/removal of paper with rolled clamber's edges.

Independently replaceable Pad
it can be independently replaced as it is fastened to machine's base with screws. And surely saves your repairing cost.



Photo: DBO380

Continuous run time

High speed mode

about 50 min

Battery: BL1860B (on a full battery charge)

Speed control by push button

3-stage electric speed control: 4,000/ 8,000/ 12,000min⁻¹

Available with Dust bag or Dust box

Also connectable to Makita vacuum cleaners



9035H Finishing Sander

Ergonomic tool body for controlled operation

419



Continuous Rating Input	180W
Pad Size	93 x 185 mm (3-5/8" x 7-1/4")
Abrasive Paper Size	93 x 228 mm (3-5/8" x 9")
Orbits Per Minute (OPM)	11,000
Dimensions (L x W x H)	236x93x146mm (9-1/4"x3-5/8"x5-3/4")
Net Weight	1.5kg (3.3lbs)
Power Supply Cord	2.5m (8.2ft)



Abrasive Paper X 6

BO3710 Finishing Sander

11,000 OPM for increased efficiency and smooth finish sanding

64



Continuous Rating Input	190W
Pad Size	93 x 185 mm (3-5/8" x 7-1/4")
Abrasive Paper Size	93 x 228 mm (3-5/8" x 9")
Orbits Per Minute (OPM)	11,000
Strokes Per Minute (SPM)	22,000
Orbit Diameter	2.0 mm (1/16")
Dimensions (L x W x H)	253x92x154mm (10"x3-5/8"x6-1/16")
Net Weight	1.6 kg (3.5 lbs)
Power Supply Cord	2.0 m (6.6 ft)



Abrasive Paper, Punch Plate, Dust Bag or Dust Box

DBO481RTJ / Z Cordless Finishing Sander

18V LXT Li-Ion 1/4 Sheet Finishing Sander

Li-ion Ah 6.0 5.0 3.0 1.5



Pad Size	112x102mm (4-3/8x4")
Abrasive Paper Size	Clamp type: 140 x 114 mm (5-1/2 x 4-1/2")
Orbits Per Minute (OPM)	High:14,000, Low: 11,000 w/BL1830B / BL1850B / BL1860B:
Dimensions (L x W x H)	171 x 112 x 151 mm (6-3/4 x 4-3/8 x 5-15/16")
Net weight	1.4 - 1.7 kg (3.1 - 3.8 lbs.)

DBO481RTJ DBO481Z

18V



Abrasive Paper, Dust Bag / Dust Box, Punch Plate, Z: Battery and Charger are sold separately

BO4510H 110mm x 100mm (4-5/16 x 3-15/16") Finishing Sander

Ergonomic tool body for controlled operation

419



Continuous Rating Input	170W
Pad Size	110 x 100 mm (4-5/16" x 3-15/16")
Abrasive Paper Size	114 x 140 mm (4-1/2" x 5-1/2")
Orbits Per Minute (OPM)	12,000
Dimensions (L x W x H)	116x110x129mm (4-9/16"x4-5/16"x5-1/8")
Net Weight	1.1kg (2.4lbs)
Power Supply Cord	2.5m (8.2ft)



Abrasive Paper X 6

BO4556 112mm x 102mm (4-3/8 x 4") Finishing Sander

Powerful 200W motor, low vibration, low noise

419



Continuous Rating Input	200W
Pad Size	112 x 102 mm (4-3/8" x 4")
Abrasive Paper Size	114 x 140 mm (4-1/2" x 5-1/2")
Orbits Per Minute (OPM)	14,000
Dimensions (L x W x H)	131x112x141mm (5-1/8"x4-3/8"x5-9/16")
Net Weight	1.1kg (2.5lbs)
Power Supply Cord	2.0m (6.6ft)



Abrasive Paper, Dust Bag, Punch Plate

DBS180Z 9mm Cordless Belt Sander

Large 533 mm (21") belt length for faster work

Li-ion Ah 6.0 5.0 3.0 1.5



Belt Width	6/9 / 13 mm (1/4 / 3/8 / 1/2")
Belt Length	533 mm (21")
Belt Speed	600 - 1,700 m/min
Max Output	530W
Dimensions (L x W x H)	w/BL1830B / BL1850B / BL1860B: 500 x 96 x 116 mm (19-3/4 x 3-3/4 x 4-9/16") w/ Side Grip & BL1830B /BL1850B / BL1860B: 500 x 245 x 126 mm (19-3/4 x 9-5/8 x 5")
Net weight	1.8 - 2.1 kg (4.0 - 4.6 lbs.)

18V



Sanding Belt, Grip, Grip Base, Battery, Charger, Z: Battery and Charger are sold separately

9031 30mm x 533mm (1-3/16" x 21") Belt Sander

Optimum for use in close quarters or on irregular shapes

411



Continuous Rating Input	550W
Belt Size	30 x 533mm (1-1/8" x 21")
Belt Speed	200 - 1,000m / min. (656 - 3,280ft/ min)
Overall Length	380 mm (15")
Net Weight	2.1kg (4.6lbs)
Power Supply Cord	2.5m (8.2ft)



Abrasive Belts set, Grip

9924DB 76mm x 610mm (3" x 24") Belt Sander

Sufficient power, proven reliability and well balanced design

100



Continuous Rating Input	850W
Belt Size	76 x 610, 620mm (3" x 24, 24-3/8")
Belt Speed	400m / min. (1,300ft/ min)
Overall Length	355 mm (14")
Net Weight	4.8kg (10.6lbs)
Power Supply Cord	5.0m (16.4ft)



Abrasive Belt, Carbon Plate, Dust Bag Assembly

DUST EXTRACTION

PRODUCTS



UB001GM201(RMX) / GZ Cordless Blower

Powerful blowing force (Max 17N)

Li-ion 8.0 | 5.0 | 4.0 | 2.5 | 2.0

Max Air Volume	15.8 m ³ /min (554 CFM)
Max Air Velocity	62 m/s (140 MPH)
No Load Speed (RPM)	0-23,000
Dimensions (L x W x H)	850-950 x 167 x 297 mm (33-1/2-37-1/2 x 6-9/16 x 11-3/4")
Net weight	3.1-3.9 kg (6.8-8.6 lbs.)



40Vmax



Shoulder Belt, End Nozzle, Flat Nozzle, Extension Nozzle (country-spec), Adapter Pipe (country-spec), Battery, Charger, Z: Battery and Charger are sold separately

UB003CZ Battery Powered Blower

New

Powerful blowing force (Max 24N)

Max Air Volume	w/ End nozzle, w/ PDC1500, Max speed mode: 17.6 m ³ /min
Max Air Velocity	w/ End nozzle, w/ PDC1500, Max speed mode: 86.0 m/s
Avg. Air Velocity	w/ End nozzle, w/ PDC1500, Max speed mode: 11.7-71.9 m/s
Blowing Force	w/ End nozzle, w/ PDC1500, Max speed mode: 0.7-24 N
No Load Speed (RPM)	Mode1 / Mode2 / Mode3: 4,000-10,600 / 17,700 / 22,100 min ⁻¹
Dimensions (L x W x H)	w/ Nozzle: 913-1,013 x 178 x 298 mm
Net weight	2.8-3.1 kg (6.2-6.8 lbs.)



End nozzle, Band assembly



High power & Lightweight design

Continuous run time (approx) on a full battery charge with PDC1500

60 min

Maximum speed mode or maximum speed with the cruise control lever / With standard nozzle attached

1,500Wh-class high capacity

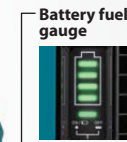

Portable Power Pack PDC1500
WG WETGUARD

Nozzle reducing reaction force

The recoil of the machine tilting is reduced with the grip as the fulcrum since the reaction force is directed toward the grip by tilting the nozzle tip downward, therefore, the burden on the user's arm is reduced.



Variable control trigger + Cruise control lever



Battery Powered Blower UB003C



UB003C	PDC1500		
Average blowing force	Max air volume	Max air velocity	Charging time 450 min. with DC4001
24 N	17.6 m³/min	86.0 m/s	
Maximum speed mode or maximum speed with the cruise control lever, with PDC1500 / With standard nozzle attached			

UB001CZ Battery Powered Blower

Powerful blowing force (Max 20N)



Max Air Volume	Cruise Control Mode: 0 - 15.0 m ³ /min Boost Mode: 17.6 m ³ /min
Max Air Velocity	Cruise Control Mode: 0 - 60 m/s Boost Mode: 70
Avg. Air Velocity	Cruise Control Mode: 0 - 50 m/s Boost Mode: 58
Blowing Force	Cruise Control Mode: 0 - 15.0 Boost Mode: 20.0
No Load Speed (RPM)	Cruise Control Mode: 0 - 21,000 Boost Mode: 24,000
Dimensions (L x W x H)	960 - 1,060 x 295 x 180 mm
Net weight	2.6 - 2.9 kg (5.7 - 6.5 lbs.)



Shoulder Belt, End Nozzle, Flat Nozzle (country-specific), Extension Nozzle (country-specific), Adapter Pipe (country-specific)

UB002CZ01 Battery Powered Backpack Blower

BL Brushless Battery Powered Variable Speed Blower



Max Air Volume	w/ End nozzle: 0 - 19.0 m ³ /min w/ Flat nozzle: 0 - 17.9 m ³ /min
Max Air Velocity	w/ End nozzle: 0 - 71.7 m/s w/ Flat nozzle: 0 - 76.0 m/s
Blowing Force	0 - 22.0 N
No load speed (RPM)	0 - 22,000
Continuous run time on a full battery charge	78 min
Sound power level	95.5 dB(A)
Dimensions (L x W x H)	w/o Nozzle: 267 x 565 x 715 mm (10-1/2 x 22-1/4 x 28-1/8") w/ Nozzle: 1,368 x 694 x 715 mm (54 x 27-1/4 x 28-1/8")
Net Weight	15.9 - 16.1 kg (35.1 - 35.4 lbs.)



Adapter Pipe, Flat Nozzle, Extension Nozzle

DUB363ZV Cordless Blower

Able to use both in Blower and Vacuuming applications

Li-ion Ah 6.0 5.0 3.0 1.5



Max Air Volume	13.4 m ³ /min (473 CFM)
Max Air Velocity	65 m/s
No Load Speed (RPM)	0 - 7,850
Dimensions (L x W x H)	w/ 3-Stage Telescopic Long Nozzle: 737/786/836x200x415 mm (7-7/16"/31") 33"x7-7/8"x16-3/8"
Net weight	4.3 - 6.6 kg (9.4 - 14.6 lbs.)



Vacuum kit, Flat Nozzle, End Nozzle, Pipe, Shoulder Belt, Hex Wrench, Battery, Charger, Z: Battery and Charger are sold separately



DUB362Z Cordless Blower

Brushless Cordless Variable 6-Speed Blower

Li-ion Ah 6.0 5.0 3.0 1.5



Capacity (Ah)	5.0 / 6.0
Energy Capacity (Wh)	90x2 / 108x2
Max Air Volume	13.4 m ³ /min (473 CFM)
Max Air Velocity	54 m/s (120 MPH)
No Load Speed (RPM)	11,400 - 21,500
Sound Power Level	93.5 dB(A)
Dimensions (L x W x H)	830/880/930x205x295mm (32-3/4"/34-3/4"/36-5/8") x8-1/8"x11-5/8"
Net weight	3.5 kg (7.7 lbs)



Fast charger, Battery cartridge, Nozzle, Shoulder belt, Z: Battery and Charger are sold separately

DUB184Z Cordless Blower

18V LXT BL Brushless Cordless Variable Speed Blower

Li-ion Ah 6.0 5.0 3.0 1.5



Max Air Volume	13.0 m ³ /min (459 CFM)
Max Air Velocity	52.1 m/s (116 MPH)
No Load Speed (RPM)	0 - 18,000
Continuous Use (min.)	w/ BL1860B: 12, w/ BL1850B: 10
Sound Pressure Level	86.6 dB(A)
Sound Power Level	93.5 dB(A)
Dimensions (L x W x H)	w/ BL1830B / BL1850B / BL1860B: 825x160x285mm (32-1/2"x6-5/16"x11-1/4")
Net weight	2.5 - 3.0 kg (5.4 - 6.7 lbs.)



Shoulder Belt, Nozzle, Battery, Charger, Hex Wrench, Z: Battery and Charger are sold separately

DUB187Z Cordless Blower Vacuum

18V LXT BL Cordless Variable Speed Blower Vacuum

Li-ion Ah 6.0 5.0 3.0 1.5



No load speed (RPM)	9,000-13,500
Max air volume (Vacuum)	6.1 m ³ /min
Max sealed suction	3.3 kPa
Dust bag capacity	25 L
Max air volume	Blower: 4.2 m ³ /min Vacuum: 6.1 m ³ /min
Max air velocity	Blower: 64.0 m/s
Max sealed suction	Vacuum: 3.3 kPa
Dimensions (L x W x H)	1,168 x 164 x 416 mm (46 x 6-1/2 x 16-3/8")
Net weight	3.7 - 4.0 kg (8.2 - 8.8 lbs.)



Dust bag, Shoulder belt, Battery, Charger, Z: Battery and Charger are sold separately



Continuous run time (approx.)
14 min
With BL1860B battery



Vacuum / Blower
Single action lever for blower / vacuum mode selection

AS001GZ02 Cordless Dust Blower

Achieves higher blowing force

Li-ion Ah 5.0 4.0 2.5 2.0



Max blowing force	Mode: 4/3/2/1: 2.8/2.3/1.7/1.1 N
Max air volume	Mode: 4/3/2/1: 1.1/1.0/0.8/0.6 m³/min
Max sealed suction	10.3 kPa
Continuous Use (min.)	Mode: 4/3/2/1: 13/17/25/50
Sound Pressure Level	79 dB(A)
Vibration Emission	2.5 m/s² or less
Dimensions (L x W x H)	w/ BL4020 / BL4025: 180 x 94 x 248 mm (7-1/8 x 3-11/16 x 9-3/4")
Net weight	1.5 - 2.3 kg (3.3 - 5.1 lbs.)

40Vmax 3

Nozzle 3, Nozzle 7, Nozzle 13, Pinch valve nozzle, Wide range nozzle, Battery, Charge, Country-specific Flexible nozzle complete, Air vent hose complete, Rubber attachment 20-30, Rubber attachment, Filter C complete, Belt clip, Z: Battery and Charger are sold separately

DAS180Z Cordless Dust Blower

18V LXT BL Cordless Air Duster

Li-ion Ah 6.0 5.0 3.0 1.5



Air volume	0-1.1 m³/min
Air velocity	0-150 m/s
Air pressure	0-18.0 kPa
Blowing force	Mode 1: 0-1.1 N Mode 4: 0-2.8 N
Max Sealed Suction	9.3 kPa
Continuous Use (min.)	BL1860B, Mode 1: 55 BL1860B, Mode 4: 15
Dimensions (L x W x H)	w/o Battery: 173 x 92 x 247 mm (6-13/16 x 3-5/8 x 9-3/4")
Net weight	1.2 - 1.7 kg (2.6 - 3.7 lbs.)

18V 1

Nozzle, Pinch valve nozzle, Wide range nozzle, Flexible nozzle, Air vent hose, Rubber attachment, Filter, Belt clip, Battery, Charger, Z: Battery and Charger are sold separately

DUB186Z Cordless Blower

18V LXT Cordless Variable 3-Speed Blower

Li-ion Ah 6.0 5.0 3.0 1.5



Max Air Volume	3.2 m³/min
Max Air Velocity	68 m/s
No Load Speed (RPM)	0 - 18,000
Blowing Force	2.5 N
Sound Power Level	92.4 dB(A)
Dimensions (L x W x H)	w/ BL1815N: 859x156x195 mm (33-3/4"x6-1/8"x7-5/8") w/ BL1830B / BL1850B / BL1860B: 861x156x210 mm (34"x6-1/8"x8-1/4")
Net weight	1.6 - 2.1 kg (3.5 - 4.6 lbs.)

18V 1

Garden Nozzle, Battery, Charger, Z: Battery and Charger are sold separately

UB101DZ Cordless Blower

12Vmax CXT Cordless Variable 3-Speed Blower

Li-ion Ah 5.0 4.0 2.0 1.5



Max Air Volume	2.6 m³/min
Max Air Velocity	56 m/s
Max Sealed Suction	N/A kPa
No Load Speed (RPM)	0 - 15,800
Blowing Force	1.6 N
Run Time (min)	w/ BL1016, High / Mid / Low: 7 / 20 / 45
Dimensions (L x W x H)	w/ BL1016/BL1021B: 849 x 155 x 184 mm (33-1/2 x 6-1/8 x 7-1/4") w/ BL1041B: 852 x 155 x 202 mm (33-1/2 x 6-1/8 x 8")
Net weight	1.4 - 1.9 kg (3.1 - 4.2 lbs.)

12Vmax 1

Garden Nozzle, Flexible Hose (country-specific), Battery, Charger, DZ: Battery and Charger are sold separately

DUB185Z Cordless Blower

18V LXT Cordless Variable 3-Speed Blower

Li-ion Ah 6.0 5.0 3.0 1.5



Max Air Volume	3.2 m³/min
Max Air Velocity	98 m/s
Max Sealed Suction	5.8 kPa
No Load Speed (RPM)	0 - 18,000
Blowing Force	3.1 N
Sound Power Level	94 dB(A)
Dimensions (L x W x H)	w/ BL1815N: 515x156x195 mm (20-1/4"x6-1/8"x7-5/8") w/ BL1830B / BL1850B / BL1860B: 517x156x210 mm (20-3/8"x6-1/8"x8-1/4")
Net weight	1.6 - 2.1 kg (3.5 - 4.6 lbs.)

18V 3

Nozzle, Battery, Charger, Z: Battery and Charger are sold separately

UB100DZ Cordless Blower

12Vmax CXT Cordless Variable 3-Speed Blower

Li-ion Ah 5.0 4.0 2.0 1.5



Max Air Volume	2.6 m³/min
Max Air Velocity	75 m/s
Max Sealed Suction	4.0 kPa
No Load Speed (RPM)	0 - 15,800
Blowing Force	1.8 N
Run Time (min)	w/ BL1016, High / Mid / Low: 8 / 20 / 45
Dimensions (L x W x H)	w/ BL1016/BL1021B: 505 x 155 x 184 mm (19-7/8 x 6-1/8 x 7-1/4") w/ BL1041B: 508 x 155 x 202 mm (20 x 6-1/8 x 8")
Net weight	1.4 - 1.9 kg (3.1 - 4.2 lbs.)

12Vmax 1

Nozzle, Dust Bag (country-specific), Flexible Hose (country-specific), Battery, Charger, DZ: Battery and Charger are sold separately

UB1102 Blower

High output air volume

303



Continuous Rating Input	600W
Air Volume	4.1 m³/min
Air Pressure	5.7 kPa
No Load Speed (RPM)	16,000
Dimensions (L x W x H)	479x185x178 mm (18-7/8"x7-1/4"x7")
Net Weight	1.9 - 2.2 kg (4.3 - 4.8 lbs.)
Power Supply Cord	2.5 m (8.2 ft.)

2

Nozzle Assembly Front Cuffs 24, Poly Bag Set

UB1103 Blower

High output air volume

303



Continuous Rating Input	600W
Air Volume	0-4.1 m³/min
Air Pressure	0-5.7 kPa (0-580 mmH ₂ O)
No Load Speed (RPM)	0-16,000
Dimensions (L x W x H)	479x185x178mm (18-7/8"x7-1/4"x7")
Net Weight	2.0kg (4.3lbs)
Power Supply Cord	2.5m (8.2ft)

110V 2

Nozzle Assembly Front Cuffs 24, Poly Bag Set

VC006GMZ03 (Wet & Dry) Cordless Vacuum Cleaner

80Vmax XGT BL AWS Cordless 40L Dust Class M GYUPPA Vacuum Cleaner

Li-ion Ah 8.0 5.0 4.0 2.5 2.0



Capacity	Dust / Water: 40 / 30 L
Max Air Flow	w/ Hose 28-3.5: 2.0 m ³ /min w/ Hose 38-2.5: 3.7 m ³ /min
Max Sealed Suction	18 kPa
Suction Power	350 W
Dimensions (L x W x H)	586 x 385 x 598 mm (23 x 15-1/8 x 23-1/2")
Net weight	18.4 - 20.8 kg (40.6 - 45.9 lbs.)

40Vmax x2



Floor nozzle, Straight pipe, Bent pipe, Hose, Dust bag, Corner nozzle, Front cuffs (22, 24), Wireless unit, Cap, Joint, Battery, Charger, Z: Battery and Charger are sold separately

VC003GLZ (Wet & Dry) Cordless Vacuum Cleaner

40Vmax BL Cordless 15L Vacuum Cleaner

Li-ion Ah 8.0 5.0 4.0 2.5 2.0



Capacity	Dust / Water: 15 / 12 L
Continuous Use (min.)	BL4050F x2: 220
Max Air Flow	3.2 m ³ /min
Max Sealed Suction	23 kPa
Suction Power	310 W
Dimensions (L x W x H)	366 x 334 x 475 mm (14-3/8 x 13-1/8 x 18-3/4")
Net weight	8.3 - 10.2 kg (18.3 - 22.5 lbs.)

40Vmax



Floor Nozzle, Long Sash Nozzle, Telescopic pipe assembly, Bent Pipe, Pipe, Hose, Plastic Dust Bag x10, Filter, Tool Box, Battery, Charger, Z: Battery and Charger are sold separately

Dust class M approved
Tank capacity Dry / Wet 40 / 30 L



photo: VC006GM

Automatic self-cleaning filter system

Automatically removes dust adhering to filter even in continuous use, reducing clogging of the filter to suppress decrease in suction power.



Max air flow

Hose size: ø38mm x 2.5m

3.7 m³/min.

Hose size: ø28mm x 3.5m

2.0 m³/min.

Continuous use

Battery: BL4050F x2

[at dial Min] [at dial Max]

80 min. 25 min.



VC004GLZ (Dry) Cordless Vacuum Cleaner

40Vmax BL AWS Cordless 15L HEPA GYUPPA Vacuum Cleaner

Li-ion Ah 8.0 5.0 4.0 2.5 2.0



Capacity	Dust: 15 L
Continuous Use (min.)	BL4050F x2: 220
Max Air Flow	1.8 m ³ /min
Max Sealed Suction	23 kPa
Suction Power	205 W
Dimensions (L x W x H)	366 x 334 x 475 mm (14-3/8 x 13-1/8 x 18-3/4")
Net weight	8.5 - 10.4 kg (18.7 - 22.9 lbs.)

40Vmax



Powder Filter H Set, Damper Set, Pre Filter Set, Hose (38mm-2.5m), Cuff Lock, Stopper, Sleeve, Front cuffs (38, 22, 24) Battery, Charger, Wireless Unit, Z: Battery and Charger are sold separately

DVC150LZ (Wet & Dry) Corded and Cordless Vacuum Cleaner

Powered by AC and Two 18V Li-Ion Batteries in Series

353

Li-ion Ah 6.0 5.0 3.0 1.5



Capacity	Dust / Water: 15 / 12 L
Max Air Flow	AC / DC: 3.6 / 2.1 m ³ /min
Max Sealed Suction	AC / DC: 24 / 9 kPa
Suction Power	AC / DC: 320 / 25 - 70 W
Vibration Level	2.5 m/s ² or less
Sound Pressure Level	75 dB(A)
Dimensions (L x W x H)	366x334x421 mm (14-3/8"x13-1/8"x16-1/2")
Net weight	8.9 - 9.6 kg (19.7 - 21.1 lbs.)

18V x2



Floor Nozzle, Corner Nozzle, Straight Pipe, Bent Pipe, Hose (38mm-2.5m), Plastic Dust Bag, Plastic Dust Bag x10, Cloth Filter, Tool Box, Connection cord (country-specific), Battery, Charger, Z: Battery and Charger are sold separately

DVC155LZX2 (Wet & Dry) Cordless Vacuum Cleaner

18V X2 (36V) LXT BL Cordless 15 L Dust Class L Vacuum Cleaner (Wet & Dry)

Li-ion Ah 6.0 5.0 3.0 1.5



Capacity	Dust / Water: 15 / 12 L
Max Air Flow	2.1 m ³ /min
Max Sealed Suction	11 kPa
Suction Power	105 W
Dimensions (L x W x H)	366x334x421 mm (14-3/8"x13-1/8"x16-1/2")
Net weight	7.2 - 7.9 kg (16.1 - 17.4 lbs.)

18V x2



Floor Nozzle, Long Sash Nozzle, Telescopic pipe assembly, Bent Pipe, Pipe, Hose, Plastic Dust Bag x10, Filter, Tool Box, Battery, Charger, Z: Battery and Charger are sold separately

DVC860LZ (Wet & Dry) Corded and Cordless Vacuum Cleaner

8L Large dust bag capacity enables continuous cleaning work

353

Li-ion Ah 6.0 5.0 3.0 1.5



Capacity	Dust / Water: 8 / 6 L
Continuous Use (min.)	With BL1850B x 2: 65
Max Air Flow	AC / DC: 3.6 / 2.1 m ³ /min
Max Sealed Suction	AC / DC: 24 / 9 kPa
Suction Power	AC / DC: 320 / 25 - 70 W
Dimensions (L x W x H)	366x334x368mm (14-3/8"x13-1/8"x14-1/2")
Net weight	8.6 kg (19.0 lbs.)

18V x2



DVC860L: Floor Nozzle, Corner Nozzle, Straight Pipe, Bent Pipe, Hose (38mm-2.5m), Plastic Dust Bag, Plastic Dust Bag x10, Cloth Filter, Tool Box, Connection cord (country-specific), Z: Battery and Charger are sold separately

DVC865LZX2 (Wet & Dry)
Cordless Vacuum Cleaner

18V X2 (36V) LXT BL Cordless 8 L Dust Class L Vacuum Cleaner (Wet & Dry)

Li-ion Ah 6.0 | 5.0 | 3.0 | 1.5



Capacity	Dust/Water: 8/6 L
Max Air Flow	2.1 m ³ /min
Max Sealed Suction	11 kPa
Suction Power	105 W
Dimensions (L x W x H)	366x334x368 mm (14-3/8"x13-1/8"x14-1/2")
Net weight	7.0-7.7 kg (15.7- 17.0 lbs.)

18V x2



Floor Nozzle, Long Sash Nozzle, Telescopic pipe assembly, Bent Pipe, Hose, Plastic Dust Bag x10, Filter, Tool Box, Battery, Charger, Z: Battery and Charger are sold separately

DVC867LZX4 (Dry) Cordless Vacuum Cleaner

18V X2 (36V) LXT BL AWS Cordless 8 L Dust Class L HEPA Vacuum Cleaner (Dry only)

Li-ion Ah 6.0 | 5.0 | 3.0 | 1.5



Capacity	Dust/Water: 8/- L
Max Air Flow	2.4 m ³ /min
Max Sealed Suction	11 kPa
Suction Power	110 W
Dimensions (L x W x H)	366x334x368 mm (14-3/8"x13-1/8"x14-1/2")
Net weight	7.7-8.4 kg (17.2- 18.5 lbs.)

18V x2



Floor Nozzle, Corner Nozzle, Straight Pipe, Bent Pipe, Hose (38mm-2.5m), Plastic Dust Bag, Plastic Dust Bag x10, Cloth Filter, Tool Box, Battery, Charger, Wireless Unit, Z: Battery and Charger are sold separately

DVC560PG2 / Z Cordless Upright Cleaner

18V X2 (36V) LXT BL Brushless Cordless 5 L HEPA Upright Cleaner

Li-ion Ah 6.0 | 5.0 | 3.0 | 1.5



Capacity	Dust: 5 L
Continuous Use (min.)	w/ BL1860B x2 Max / Normal / Low Noise: 30 / 60 / 120
Max Air Flow	1.9 m ³ /min
Max Sealed Suction	12 kPa
Suction Power	Max / Normal / Low Noise: 85 / 50 / 25 W
Cleaning Width	318 mm
Brushroll Rotation Speed	Max / Normal / Low Noise: 3,500 / 2,500 / 1,000 RPM
Dimensions (L x W x H)	326 x 318 x 1,146 mm (12-7/8 x 12-1/2 x 45")
Net weight	8.3-9.0 kg (18.3- 19.8 lbs.)

18V x2



Long Sash Nozzle, Round Brush, Filter Bag, Filter H, Filter Bag Set, Z: Battery and Charger are sold separately

VC011GZ Cordless Backpack Vacuum Cleaner

40Vmax XGT BL Brushless Cordless HEPA Backpack Vacuum Cleaner

Li-ion Ah 8.0 | 5.0 | 4.0 | 2.5 | 2.0



Capacity	Paper Dust Bag: 6.0 L Cloth Dust Bag: 5.5 L
Max Air Flow	2.4 m ³ /min
Max Sealed Suction	20 kPa
Continuous use (approx.) on a full battery charge	w/ BL4050F x2: Mode 1/2/3/4: 260 / 130 / 75 / 40 min
Suction Power	Mode 1/2/3/4: 25W/ 55W/ 100W/ 195W w/ BL4040 x2: 301 x 185 x 526 mm (11-7/8 x 7-1/4 x 20-3/4")
Dimensions (L x W x H)	
Net weight	6.4-9.5 kg (14.1-20.9 lbs.)

40Vmax



Hose, Hose band, Dust bag, Switching nozzle, Bent pipe with pipe locking mechanism, Aluminum telescopic pipe with pipe locking mechanism (country-specific), Long sash nozzle, Battery, Charger, Z: Battery and Charger are sold separately

VC008GZ04 Cordless Backpack Vacuum Cleaner

40Vmax XGT BL Brushless Cordless HEPA Backpack Vacuum Cleaner

Li-ion Ah 8.0 | 5.0 | 4.0 | 2.5 | 2.0



Capacity	Paper Dust Bag: 2.0 L Cloth Dust Bag: 1.5 L
Max Air Flow	2.4 m ³ /min
Max Sealed Suction	18 kPa
Suction Power	w/ Hose 32-1.0 (Max): 180 W
Dimensions (L x W x H)	233 x 151 x 376 mm (9-1/8 x 5-15/16 x 14-3/4")
Net weight	4.3-4.7 kg (9.5- 10.4 lbs.)

40Vmax



Floor Nozzle, Hose, Hose Band, Nozzle, Telescopic pipe assembly, Bent Pipe, Switching nozzle, Free Nozzle, Dust Bag, Front Cuff (country-specific), Battery, Charger, Z: Battery and Charger are sold separately



For Cleaning
VC011G

Powered by
40Vmax XGT
Li-Ion battery
(two in parallel or one)

HEPA
filter

VC009GZ Cordless Backpack Vacuum Cleaner

40Vmax XGT BL AWS Cordless HEPA Backpack Vacuum Cleaner

Li-ion Ah 8.0 | 5.0 | 4.0 | 2.5 | 2.0



Capacity	Paper Dust Bag: 2.0 L Cloth Dust Bag: 1.5 L
Max Air Flow	1.9 m ³ /min
Max Sealed Suction	18 kPa
Suction Power	w/ Hose 28-1.5, Max / High / Normal: 165 / 85 / 45
Dimensions (L x W x H)	233 x 151 x 376 mm (9-1/8 x 5-15/16 x 14-3/4")
Net weight	4.3-4.7 kg (9.5- 10.4 lbs.)

40Vmax



Hose, Hose Band, Dust Bag, Front Cuff (country-specific), Wireless Unit, Battery, Charger, Z: Battery and Charger are sold separately

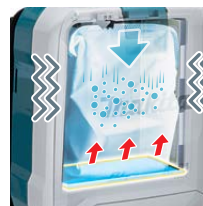

Automatic filter cleaning mechanism

The board with springs located beneath the dust bag rocks due to walking vibration to remove dust from the bag, reducing filter clogging to maintain suction power.

Telescopic pipe with lock

- A locking mechanism has been added to the connection of bending pipe and this pipe to prevent from falling off.
- Available in lightweight plastic and rigid aluminum

Locking mechanism

Telescoping button



48 mm

Max Suction power

Low noise

Max Sealed Suction

195 W
mode: 4 / With ø32mm x 1.0m Hose

55 dB(A)
mode: 1

20 kPa

DVC660ZX7
Cordless Backpack Vacuum Cleaner

18V X2 (36V) LXT BL Brushless HEPA Cordless Backpack Vacuum Cleaner

Li-ion Ah 6.0 | 5.0 | 3.0 | 1.5



Capacity	Paper Dust Bag: 6.0 L Cloth Dust Bag: 5.5 L w/ Hose complete 32-1.0: 2.2 m ³ /min w/ Hose Complete 28-1.0: 2.0 m ³ /min
Suction Power	Max / High / Normal w/ Hose 32-1.0: 95 / 50 / 25 W Max / High / Normal w/ Hose 28-1.0: 90 / 45 / 25 W
Vibration Level	Operation w/o Load: 2.5 m/s ² or less
Dimensions (L x W x H)	297x174x523 mm (11-3/4"x6-7/8"x20-5/8")
Net weight	6.1 - 6.7 kg (13.4 - 14.8 lbs.)

18V x2



Floor Nozzle, Hose, Hose Band, Nozzle assembly, Telescopic pipe assembly, Bent Pipe, Switching nozzle, Free Nozzle, Dust Bag, Front Cuffs (22, 24), Battery, Charger, Z: Battery and Charger are sold separately

DVC665Z
Cordless Backpack Vacuum Cleaner

18V X2 (36V) LXT BL AWS HEPA Cordless Backpack Vacuum Cleaner

Li-ion Ah 6.0 | 5.0 | 3.0 | 1.5



Capacity	Paper Dust Bag: 6.0 L Cloth Dust Bag: 5.5 L w/ Hose Complete 28-1.5: 1.8 m ³ /min
Max Air Flow	High / Normal w/ Hose 28-1.5: 85 / 45 W
Suction Power	Operation w/o Load: 2.5 m/s ² or less
Vibration Level	2.5 m/s ² or less
Dimensions (L x W x H)	297x174x523 mm (11-3/4"x6-7/8"x20-5/8")
Net weight	6.1 - 6.7 kg (13.5 - 14.9 lbs.)

18V x2



Floor Nozzle, Hose, Hose Band, Nozzle assembly, Telescopic pipe assembly, Bent Pipe, Switching nozzle, Free Nozzle, Dust Bag, Front Cuffs (22, 24), Battery, Charger, Z: Battery and Charger are sold separately

VS001GZ Cordless Vacuum Sweeper

New

40Vmax XGT BL Cordless 24 L Dust Class HEPA Vacuum Sweeper

Li-ion Ah 8.0 | 5.0 | 4.0 | 2.5 | 2.0



Dust container capacity	24 L (6.3 gal)
Continuous use (approx.) on a full battery charge	w/ BL4080F x2: 150 min
Charging time approx.	w/ BL4080F-x2, w/ DC40RA: 120 min
Sweeping capacity	2,600 m ³ /h
Cleaning width	Main brush: 480 mm (18-7/8"), Side brush: 650 mm (25-1/2")
Dimensions (L x W x H)	w/ Handle in upright position: 830 x 677 x 1,146 mm (32-3/4 x 26-3/4 x 45")
Net weight	31-34 kg (68.3-74.9 lbs.)

40Vmax



Battery, Charger, Z: Battery and Charger are sold separately

DRC300Z Robotic Cleaner

18V LXT BL Brushless Robotic Cleaner w/ Mapping Function

Li-ion Ah 6.0 | 5.0 | 3.0 | 1.5



Continuous Use (min.)	w/ BL1860B x2: 240
Max cleaning area	w/ BL1860B x2: 600 m ²
Max running speed	0.3 m/sec
Dust Box Capacity	3.0 L
Dimensions (L x W x H)	500 x 500 x 204 mm (19-3/4 x 19-3/4 x 8")
Net weight	9.6 - 10.6 kg (21.2 - 23.4 lbs.)

18V x2



Wireless remote controller (including two AAA alkaline batteries), Side Brush, Z: Battery and Charger are sold separately

Maximum cleaning area 600m² with mapping feature



Automatic return to initial position



The number of rooms that can be memorized is 5



Compatible with Smartphone app [Makita RoboPro DRC300]

Dust box capacity
3L

Continuous run time (approx.) on a full battery charge

240 min
[with two BL1860B batteries]

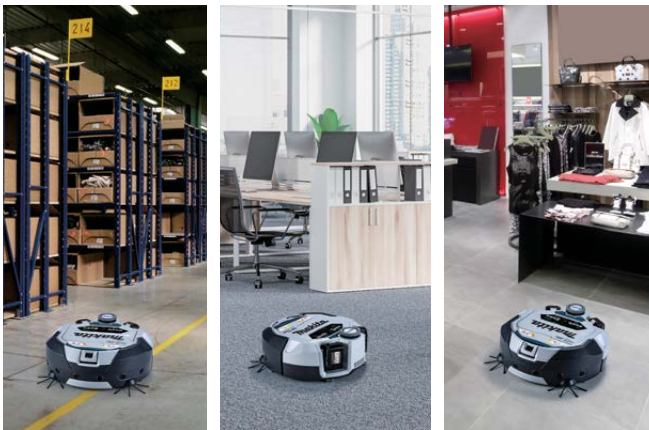

LiDAR sensor



Camera sensor



photo: DRC300

Equipped with LiDAR sensor (2D) and Camera sensor, the cleaner can map and memorize the rooms to clean.

DRC200Z Robotic Cleaner

Provides easy maneuverability anywhere you need cleaning

Li-ion Δ 6.0 5.0 3.0 1.5



Continuous use (minutes)	BL1850Bx2: 200 BL1830Bx2: 120
Max. cleaning area	BL1850Bx2: 500m ² BL1830Bx2: 300m ²
Max. running speed	0.3 m/sec
Dust box capacity	2.5L
Dimensions (L x W x H)	460x460x180mm (18-1/8" x 18-1/8" x 7-1/8")
Net weight	7.8kg (16.1lbs)

18V x2



Wireless remote controller (including two AAA alkaline batteries), Side brush, Boundary tape (15m roll), Z: Battery and Charger are sold separately

DCL184Z Cordless Cleaner

18V LXT Li-Ion Cordless 3-Speed Cleaner

Li-ion Δ 6.0 5.0 3.0 1.5



Capacity	Cloth / Paper Dust Bag: 500 / 330 mL
Continuous Use (min.)	Max / High / Normal: 33 / 50 / 133
Max Air Flow	Cleaning: 1.4 m ³ /min Blowing: 0.8 m ³ /min
Max Air Velocity	Blowing: 7.2 m/s
Max Sealed Suction (water column)	5.4 kPa (550 mmH ₂ O)
Noise Level	Max / High / Normal: 68 / 65 / 58 dB(A)
Dimensions (L x W x H)	w/ BL1830B / BL1850B / BL1860B: 365x138x202 mm (14-3/8" x 5-7/16" x 8")
Net weight	1.8 - 2.2 kg (4.0 - 4.9 lbs.)

18V



Seat Nozzle, Mat Nozzle, Rubber Nozzle, Soft Brush, Blower Attachment, Dust Bag, Paper Dust Bag, Shoulder Belt, Battery, Charger, Z: Battery and Charger are sold separately

DVC750LZX1 Cordless Portable Vacuum Cleaner

Compact, portable and easy-to-use

Li-ion Δ 6.0 5.0 3.0 1.5



Capacity	Dust / Water : 7.5 / 4.5 L
Continuous Use (min.)	w/ BL1850B (High) : 30 w/ BL1850B (Normal) : 60
Max Air Flow	1.3 m ³ /min
Max Sealed Suction	6.7 / 4.2 kPa
Suction Power	High / Low : 50 / 25 W
Dimensions (L x W x H)	418x251x278 mm (16-1/2" x 9-7/8" x 11")
Net weight	4.3 - 4.6 kg (9.4 - 10.1 lbs.)

18V



Hose, Floor Nozzle, Sash Nozzle, Z: Battery and Charger are sold separately

VC3210L Vacuum Cleaner (Wet & Dry)

Complying with dust class L

173

110V
VC3210L/B



Continuous Rating Input	1,050W
Max Peak Air Flow	2.0m ³ /min
Max Sealed Suction (Water Column)	22.0 kPa (2,240 mmH ₂ O)
Tank Capacity	Dust: 32 L Water: 27 L
Dimensions (L x W x H)	552x398x685mm (21-3/4" x 15-5/8" x 27")
Net Weight	14.5kg (32.0lbs)
Power Supply Cord	5.0m (16.4ft)



Hose Complete 28-3.5 (with Front Cuffs 38), Holder 10-33, Front Cuffs 22, Front Cuffs 24, Poly Bag Set

Dust classes in accordance with the EU standard

Since 1997, hazardous dusts have been categorized into 3 (three) classes, namely, Class L, Class M and Class H, which is regulated by IEC60335-2-69 (world wide) and by EN 60335-2-69. The vacuum cleaners suitable for each of dust class have been also defined by these regulations as follows :

Dust class	Model No.	Definition Of Dust	Major requirement	Dust permeability %
H	VC3211H	*OEL values >0.1mg/m ³ all kinds of dusts caused cancer, disease.	• Air flow sensor • Filter protection structure *1 • Structure that requires a tool for filter removal/installation *2 • Structure that protects users from exposure to dust when emptying dust bag *3	less than 0.005%
M	VC3211M, VC2211M, VC4210M, VC3012M,	*OEL values >0.1mg/m ³ as well as saw dust	• Air flow sensor • Filter protection structure *1	less than 0.1%
L	VC1310L, VC2510L, VC3210L, DVC860L, DVC861L, DVC865L, DVC866L, DVC867L, DVC750L, DVC150L, DVC151L, DVC155L, DVC156L, DVC157L, VC4210L, VC2012L, VC2512L, VC3011L, VC3012L	*OEL values >1mg/m ³		less than 1%

HEPA filter

Apart from the above standard regulated by IEC/EN 60335-2-69, "HEPA" is widely recognized as one of famous guidelines of the filtration efficiency.

According to this standard, the filter of "HEPA" should remove more than 99.75% of airborne particles of 0.3µm in diameter.

Thus, it stipulates only a filtration efficiency of the filter itself, while IEC/EN60335-2-69 defines the vacuum machine suitable for each dust class (construction, mechanical strength of machine) as well as its dust permeability. In this sense, Dust Class H vacuum cleaner does not always have to be equipped with HEPA filter as long as it meets the requirements of IEC/EN60335-2-69. Another difference between HEPA testing methods and the IEC/EN60335-2-69 is the dust loading.

Filter elements for dust classes M and H are to be tested with the limestone dust particles in large quantities for checking the physical strength of filter, while HEPA tests are done with very small liquid droplets.

* OEL : Occupation Exposure Limit

In dirty indoor environment with high activity, such as schools, the average values of OEL are measured 0.5mg/m³. In case of "non-activity place", 0.15mg/m³ in office and 0.2mg/m³ in school are measured in average.

*1 Filters should be protected from sharp objects such as nails when they are accidentally sucked up. The solution for VC3211M/ VC3211H is a protector for the filter units.

*2 Filters loaded with dust should not be easily removed. The solution for VC3211H is a screw that locks the filter unit lock lever to the lock plate.

*3 Dust should be prevented from flying around when emptying dust bags or replacing filters. The solution for VC3211H is the filter bag already available as an optional accessory of VC3211M.

*4 Permeability of limestone (marble) particles having a diameter of 5 microns or less, in accordance with the EU standard

VC2510L Vacuum Cleaner (Wet & Dry)

Complying with dust class L

173



Continuous Rating Input	1,050W
Max Peak Air Ow	2.0m ³ / min
Max Sealed Suction (Water Column)	22.0 kPa (2,240 mmH ₂ O)
Tank Capacity	Dust: 25 L Water: 14 L
Dimensions (L x W x H)	432x416x451 mm (17"x16-3/8"x17-3/4")
Net Weight	10.5kg (23.2lbs)
Power Supply Cord	5.0m (16.4ft)



Hose Complete 28-3.5 (with Front Cuffs 38), Holder 10-33, Front Cuffs 22, Front Cuffs 24, Plastic Dust Bag Set

VC2000L Vacuum Cleaner (Wet & Dry)

Wet & Dry L-class Vacuum Cleaner



Continuous rating Input	1,000W
Max. peak air flow	216 m ³ / h
Max. sealed suction	21 kPa
Tank capacity	Dust: 20L Water: 13L
Dimensions (L x W x H)	375x 385 x 505mm (14-7/8" x 15-1/5" x 19-8/8")
Net Weight	7.5kg (16.5lbs)
Power supply cord	5.0m (16.4ft)



Filter Bag - Fleece, Disposal Bag - Plastic, Suction Hose, Suction Tube, Hand tube, Floor Nozzle, Nozzle Universal, Crevice Nozzle

CL001GD115(RD/T+B) / GD126(RD/T+W) / GZ04(Z/T+B) / GZ12(Z/T+W) Cordless Cleaner

40Vmax XGT BL Brushless Cordless 4-Speed Cleaner with LED Light

Li-ion Ah 8.0 | 5.0 | 4.0 | 2.5 | 2.0



Capacity	730 mL
Continuous Use (min.)	w/BL4040, 1 / 2 / 3 / 4: 128 / 64 / 40 / 25
Max Air Flow	1.2 m ³ /min
Max Sealed Suction (water column)	21 kPa (2,100 mmH ₂ O)
Suction Power	w/ Easy Shake Off Filter, 1 / 2 / 3 / 4: 20 / 45 / 70 / 125 W
Dimensions (L x W x H)	w/BL4020 / BL4025: 1,066 x 113 x 152 mm w/BL4040: 1,081 x 113 x 152 mm
Net weight	1.7-2.3 kg (3.5-5.1 lbs.)



Floor Nozzle, Sash Nozzle, Sash Nozzle Holder, Pipe, Filter H, Easy Shake Off Filter, Battery, Charger, Z: Battery and Charger are sold separately

CL002GZ03(ZB) / GZ07(ZW) Cordless Cleaner

40Vmax XGT BL Brushless Cordless 4-Speed Cleaner with LED Light

Li-ion Ah 8.0 | 5.0 | 4.0 | 2.5 | 2.0



Capacity	Dust Bag: 500 mL Paper Pack: 330 mL
Continuous Use (min.)	w/BL4025, 1 / 2 / 3 / 4: 80 / 40 / 25 / 16
Max Air Flow	1.2 m ³ /min
Max Sealed Suction (water column)	21 kPa (2,100 mmH ₂ O)
Suction Power	125 W w/ Easy Shake Off Filter, 1 / 2 / 3 / 4: 20 / 45 / 70 / 125 W
Dimensions (L x W x H)	505 x 114 x 152 mm (19-7/8 x 4-1/2 x 6")
Net weight	1.8-3.0 kg (4.0-6.6 lbs.)



Floor Nozzle, Sash Nozzle, Sash Nozzle Holder, Pipe, Easy Shake Off Dust Bag, Paper Dust Bag, Hand Strap, Battery, Charger, Z: Battery and Charger are sold separately

CL003GD115(RDB) / GD114(RDW) / GZ09(ZB) / GZ14(ZW) Cordless Cleaner

40Vmax XGT BL Brushless Cordless Cleaner

Li-ion Ah 8.0 | 5.0 | 4.0 | 2.5 | 2.0



Capacity	250 mL
Continuous use	w/BL4025, Mode 1 / 2 / 3 / 4: 4: 80 / 40 / 25 / 16 min
Max air flow	1.0 m ³ /min
Max sealed suction	20 kPa (2,000 mmH ₂ O)
Suction power	w/ Easy shake off filter EX, Mode 1 / 2 / 3 / 4: 15 / 35 / 60 / 100 W
Noise level	Mode 1 / 2 / 3 / 4: 54 / 59 / 62 / 65 dB(A)
Dimensions (L x W x H)	w/ Pipe & Nozzle, w/ BL4040: 1,121 x 113 x 177 mm (44-1/4 x 4-7/16 x 7")
Net weight	1.9-2.5 kg (4.2-5.5 lbs.)



Floor Nozzle, Sash Nozzle, Sash Nozzle Holder, Pipe, Battery, Charger, Z: Battery and Charger are sold separately

DCL286FRTB / FZB Cordless Cleaner

18V LXT BL Cordless 4-Speed Cleaner with LED Light

Li-ion Ah 6.0 | 5.0 | 3.0 | 1.5



Dust collecting type	Cyclone
Capacity	250 mL
Max Air Flow	1.0 m ³ /min
Max Sealed Suction	18 kPa
Suction power	w/ High performance filter, Mode 1 / 2 / 3 / 4: 15W / 35W / 60W / 100W
Dimensions (L x W x H)	543 x 113 x 177 mm (21-3/8 x 4-7/16 x 7")
Net weight	1.6-1.9 kg (3.5-4.2 lbs.)



Floor nozzle, Sash nozzle, Sash nozzle holder, Pipe, Battery, Charger, High performance filter (country-specific), Z: Battery and Charger are sold separately

DCL283FRTB / FZB Cordless Cleaner

18V LXT BL Cordless Cleaner with LED Light

Li-ion Ah 6.0 | 5.0 | 3.0 | 1.5



Capacity	730 mL
Max Air Flow	1.1 m ³ /min
Max Sealed Suction	17.5 kPa
Suction power	90 W
Dimensions (L x W x H)	503 x 113 x 154 mm (19-3/4 x 4-7/16 x 6-1/8")
Net weight	1.3-1.6 kg (2.9-3.5 lbs.)



Floor nozzle, Sash nozzle, Sash nozzle holder, Pipe, High performance dust bag, Battery, Charger, Z: Battery and Charger are sold separately

DCL284FRTB / FZB Cordless Cleaner

18V LXT BL Cordless 4-Speed Cleaner with LED Light

Li-ion Ah 6.0 | 5.0 | 3.0 | 1.5



Capacity	730 mL
Max Air Flow	1.2 m ³ /min
Max Sealed Suction	18 kPa
Suction power	w/ High performance filter, Mode 1 / 2 / 3 / 4: 20W / 45W / 70W / 125W
Dimensions (L x W x H)	503 x 113 x 153 mm (19-3/4 x 4-7/16 x 6-1/16")
Net weight	1.3-1.6 kg (2.9-3.5 lbs.)



Floor nozzle, Sash nozzle, Sash nozzle holder, Pipe, High performance filter, Battery, Charger, Z: Battery and Charger are sold separately

photo: DCL283F



Trigger switch

photo: DCL284F



One-touch switch

photo: DCL286F



One-touch switch

High suction power and Low noise level

- Achieved by redesigning the exhaust air flow path of the motor to reduce wind noise.
- Equipped with high-speed BL motor to ensure high suction power.

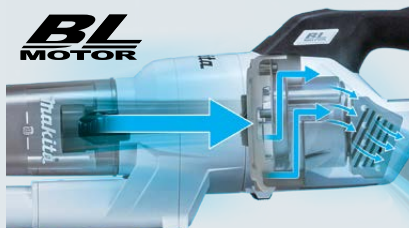

Low noise

DCL283F
63 dB(A)DCL284F
65 [Mode 4] dB(A)DCL286F
66 [Mode 4] dB(A)

Redesigned Floor/ Carpet T-nozzle

- Redesigned structure reduces the resistance caused by suction, providing smooth running.
- Redesigned inside air flow path reduces the noise made inside the nozzle.



DCL280BX12 / FZB Cordless Cleaner

18V LXT BL Brushless Cordless Cleaner with LED Light

Li-ion Ah 6.0 5.0 3.0 1.5



Capacity	750 mL
Continuous Use (min.)	with BL1830B (High): 20
Max Air Flow	1.4 m ³ /min
Max Sealed Suction (water column)	6.4 kPa (640 mmH ₂ O)
Dimensions (L x W x H)	1,016 x 113 x 155 mm (40" x 4.7" x 6.1" - 1/8")
Net weight	1.2 - 1.6 kg (2.7 - 3.5 lbs.)

DCL280FZB

18V



LXT

BL

4

Floor Nozzle, Sash Nozzle, Sash Nozzle Holder, Pipe, Filter H, Easy Shake Off Filter, Hand Strap, Battery, Charger, Z: Battery and Charger are sold separately

CL106FDSA / FDZ Cordless Cleaner

12Vmax CXT Li-Ion Cordless Cleaner

Li-ion Ah 5.0 4.0 2.0 1.5



Capacity	600 mL
Continuous Use (min.)	with BL1041B: 42
Max Air Flow	1.3 m ³ /min
Max Sealed Suction (water column)	3.1 kPa (316 mmH ₂ O)
Dimensions (L x W x H)	958 x 100 x 150 mm (37.3" x 3.9" x 5.9" - 1/8")
Net weight	1 - 1.1 kg (2.1 - 2.5 lbs.)

12Vmax



CXT

2

Floor Nozzle, Sash Nozzle, Sash Nozzle Holder, Pipe, Battery, Charger, Filter, Prefilter, DZ: Battery and Charger are sold separately

CL100DW Cordless Cleaner

Lightweight but with strong suction power (14W)

Li-ion Ah 1.3



Capacity	600 mL
Continuous Use (min.)	12
Max Air Flow	1.2 m ³ /min
Max Sealed Suction (water column)	2.3 kPa (235 mmH ₂ O)
Dimensions (L x W x H)	966 x 103 x 150 mm (38.1" x 4.1" x 5.9" - 1/8")
Net weight	0.88 kg (1.94 lbs)

10.8V

3

Battery Charger, Battery Cartridge, Nozzle Assembly, Sash Nozzle, Pipe, Filter (factory-mounted), Pre-filter (factory-mounted), DZ: Battery and Charger are sold separately

DVC350Z Cordless Vacuum Cleaner

Cordless design for high portability

Li-ion Ah 6.0 5.0 3.0 1.5



Max Air Flow	1.4 m ³ /min
Max Sealed Suction (water column)	6.0 kPa (612 mmH ₂ O)
Recoverable capacity	Dust: 3.0 L (0.8 gal)
Dimensions (L x W x H)	273 x 195 x 226 mm (10.7" x 7.7" x 8.9" - 1/8")
Net weight	2.2 - 2.4 kg (4.8 - 5.3 lbs)

Limited Qty

18V

2

LXT

1

Nozzle Assembly, Dust Bag Assembly, Hose Complete, Shoulder Belt, Z: Battery and Charger are sold separately

Capsule type



One touch switch



CL001G **40Vmax**

Easy shake off dust filter

BL **HEPA** filter

Max Air Flow **1.2m³/min** Max Sealed Suction **21 kPa**

DCL284F **18V**

Easy shake off dust filter

BL **HEPA** filter

Max Air Flow **1.2m³/min** Max Sealed Suction **18 kPa**

- Home**
- Building**
- Built-in Job Light**
- Electronic 2-Speed**
- Electronic 3-Speed**
- Electronic 4-Speed**

Paper bag type



One touch switch



CL002G **40Vmax**

Easy shake off dust bag

BL **HEPA** filter

Max Air Flow **1.2m³/min** Max Sealed Suction **21 kPa**

Cyclone attachment



Cyclone pre-separation system separates dust from air.

Easy disposal of the fine dust collected in dust case.

The main unit of the cleaner requires much less frequent dust disposal.

Capsule type



Trigger switch



DCL283F **18V**

Easy shake off dust filter

BL **HEPA** filter

Max Air Flow **1.1m³/min** Max Sealed Suction **17.5kPa**

DCL280F **18V**

Easy shake off dust filter

BL **HEPA** filter

Max Air Flow **1.4m³/min** Max Sealed Suction **6.4kPa**

CL106FD **12Vmax**

Max Air Flow **1.3m³/min** Max Sealed Suction **3.1 kPa**

Cyclone unit



One touch switch



CL003G **40Vmax**

High performance filter set

BL **HEPA** filter

Max Air Flow **1.0m³/min** Max Sealed Suction **20kPa**

DCL286F **18V**

High performance filter set

BL **HEPA** filter

Max Air Flow **1.0m³/min** Max Sealed Suction **18kPa**



POWER CUTTER

PRODUCTS



CE002GZ (Dry) 355mm (14") Cordless Power Cutter

40Vmax X2 (80Vmax) XGT BL AFT AWS Cordless 355 mm Power Cutter, Electric Brake

Li-ion Ah 8.0 | 5.0 | 4.0 | 2.5 | 2.0



Wheel Diameter	355 mm (14")
Max Cutting Capacity	127 mm (5")
No Load Speed (RPM)	4,200
Dimensions (L x W x H)	w/ BL4040: 825 x 272 x 487 mm (32-1/2 x 10-3/4 x 19-1/4")
Net weight	13.1 - 15.1 kg (28.9 - 33.3 lbs.)

40Vmax x2



Wrench, Ring, Hose clamp, Battery, Charger, Z: Battery and Charger are sold separately

CE001GZ01 (Wet & Dry) 355mm (14") Cordless Power Cutter

40Vmax X2 (80Vmax) XGT BL Cordless 355 mm Power Cutter, Electric Brake

Li-ion Ah 8.0 | 5.0 | 4.0 | 2.5 | 2.0



Wheel Diameter	355 mm (14")
Max Cutting Capacity	127 mm (5")
No Load Speed (RPM)	5,300
Dimensions (L x W x H)	w/ BL4040: 786 x 272 x 433 mm (31 x 10-3/4 x 17")
Net weight	12.3 - 14.1 kg (27.1 - 31.1 lbs.)

40Vmax x2



Hex Wrench, Flange, Water Hose Connector, Z: Battery and Charger are sold separately

PRESSURE WASHER

PRODUCTS



HW001GZ Cordless High Pressure Washer

New

Powered by 40Vmax XGT Li-Ion battery (two in parallel or one)

Li-ion Ah 8.0 | 5.0 | 4.0 | 2.5 | 2.0



Max Pressure	11.5 MPa
Max Flow Rate	7.0 L/min
Pump Speed (RPM)	Mode 1/Mode 2/Mode 3: 1,870/2,580/3,350 w BL4050F:
Continuous use (approx) on fully charged batteries	Mode 1: 60 min Mode 2: 30 min Mode 3: 18 min
Max Feed Temperature	40 °C
High Pressure Hose Length	5 m (16 ft.)
Dimensions (L x W x H)	344x383x520 mm
Net weight	8.5 kg (18.7 lbs.)

40Vmax



Z: Battery and Charger are sold separately

DHW080ZK Cordless High Pressure Washer

18V X2 LXT BL Cordless 8 MPa High Pressure Washer

Li-ion 6.0 | 5.0 | 3.0 | 1.5



Max Pressure	8.0 MPa (N/A bars)
Max Flow Rate	380 L/h (6.3 L/min)
Pump Speed (RPM)	High / Low: 3,450 / 2,390
Max Feed Temperature	40 °C (N/A °F)
Max Suction Height	1 m (3.3 ft.)
High Pressure Hose Length	5 m (16 ft.)
Sound Power Level	70.9 dB(A)
Dimensions (L x W x H)	438x218x269 mm (17-1/4"x8-5/8"x10-5/8")
Net weight	7.1 - 7.7 kg (15.6 - 17.0 lbs.)

18V x2



Trigger Gun, High Pressure Hose 5 m, Suction Hose, Cleaner Pin, Storage Box, Variable nozzle, Connector, One touch joint, Battery, Charger, Z: Battery and Charger are sold separately

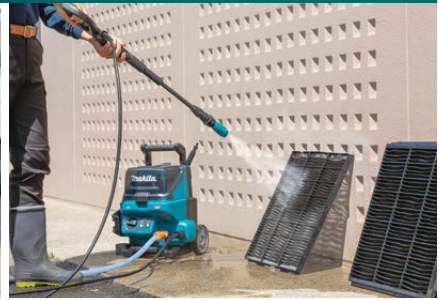
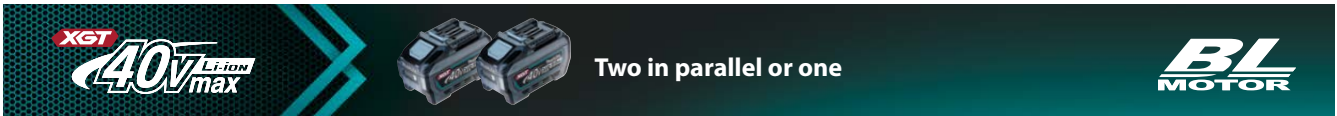

Good mobility and transportability



Large diameter wheels
Equipped with ϕ 140mm wheels, allowing for good mobility even on bumpy road surfaces.

Max permissible pressure **11.5** MPa



3 operation modes; operation mode can be selected to suit the contamination degree of the object to be cleaned.



Telescopic handle
for easy transportation and storage



Accessory storage

Side section: Trigger gun
Rear section: High pressure hose, Foam nozzle, Lance

NEW Foam nozzle set



Self-priming function



HW102 High Pressure Washer

Lightweight and compact power washer for home use



Continuous Rating Input	1,300W
Max Pressure	100bar (1,450 PSI)
Max Flow Rate	360 L/hr
Motor Type	Universal
Sound Power Level	94dB(A)
Max Input Temperature	50°C
High Pressure Hose	5m
Length	
Net Weight	5.8kg (5.0lbs)



HW1300 High Pressure Washer

High Pressure Washer with Self-Priming Function



Continuous Rating Input	1,800W
Max Pressure	13MPa
Max Flow Rate	450 L/hr
Max Feed Temperature	40 °C (104 °F)
Sound Pressure Level	76 dB(A)
High Pressure Hose	10m
Length	
Dimensions	292x358x830 mm (11-1/2"x14-1/8"x32-3/4")
Net Weight	12.7 kg (28.0 lbs.)
Cord Length	5m



Trigger Gun, Vario-Power Spray Lance, Cyclone jet nozzle, Detergent Bottle, Cleaner Pin, Coupling Sleeve, High Pressure Hose 10 m, Water Hose Connector, Foam Nozzle, Connector

HW132 High Pressure Washer

Steel reinforced spray gun



Continuous rating input	2,100W
Max Pressure	14 MPa (140 bar, 2,030 PSI)
Net weight	18.8 kg (41.4 lbs)



HW151 High Pressure Washer

Compact design, large operating range and efficient cleaning performance



Continuous Rating Input	2,500W
Max Pressure	15MPa (2,175 PSI)
Max Flow Rate	500 L/hr
Motor Type	Induction
Sound Power Level	88dB(A)
Max Input Temperature	50°C
High Pressure Hose	10m(32.8ft)
Length	
Net Weight	26.9kg (23.3lbs)



HEAT GUN

PRODUCTS



DHG181ZK Cordless Heat Gun

Max 550 degrees Celsius air temperature for a wide range of cordless works

Li-ion 6.0 5.0 3.0 1.5



Air Temperature (°C) 550°C
Air Flow Stage 1: 120 L/min
 Stage 2: 200 L/min
Dimensions (L x W x H)
 w/o Battery: 173 x 79 x 208 mm (6-3/16 x 3-1/8 x 8-3/16")
 w/ BL1815N / BL1820B: 173 x 79 x 237 mm (6-3/16 x 3-1/8 x 9-3/8")
 w/ BL1830B / BL1850B / BL1860B: 173 x 79 x 255 mm (6-3/16 x 3-1/8 x 10")
Net weight 1.0 - 1.3 kg (2.2 - 2.9 lbs.)

18V 2 1.5 LXT 2

Glass protection nozzle, Wide slot nozzle, Reflector nozzle, Reduction nozzle, Battery, Charger, Z: Battery and Charger are sold separately

DHG180ZK Cordless Heat Gun

Max 550 degrees Celsius air temperature for a wide range of cordless works

Li-ion 6.0 5.0 3.0 1.5



Air Temperature (°C) 550°C
Air Flow 200 L/min
Dimensions (L x W x H)
 w/o Battery: 168 x 79 x 205 mm (6-5/8 x 3-1/8 x 8-1/8")
 w/ BL1815N / BL1820B: 168 x 79 x 234 mm (6-5/8 x 3-1/8 x 9-1/4")
 w/ BL1830B / BL1850B / BL1860B: 168 x 79 x 251 mm (6-5/8 x 3-1/8 x 9-7/8")
Net weight 1.0 - 1.3 kg (2.2 - 2.9 lbs.)

18V 1.5 LXT 2

Glass protection nozzle, Wide slot nozzle, Reflector nozzle, Reduction nozzle, Battery, Charger, Z: Battery and Charger are sold separately

Wide Variety of Accessories

Glass protection nozzle Part No. PR00000028 	Wide-slot nozzle Part No. PR00000029 	Reflector nozzle Part No. PR00000030 	Reduction nozzle 20 Part No. PR00000031 	Overlap welding nozzle Part No. PR00000032
Solder sleeves reflector Part No. PR00000033 	Welding nozzle Part No. PR00000034 	Pressure roller Part No. PR00000035 	Scraper Part No. PR00000040 	Scraper set Part No. PR00000041 Scraper Part No. PR00000042

Maximum 550°C air temperature

Max. Air Flow 200 L/min

Photo : DHG181



HG5030 Heat Gun

2-temperature settings (350 and 500 °C) for a variety of applications



Continuous rating input 1,600W
Air Temperature (°C) / Flow (L/min) Switch 1: 350 / 300
 Switch 2: 500 / 500
Dimensions (L x W x H) 233x80x208 mm (9-1/8"x3-1/8"x8-3/16")
Net weight 0.56 kg (1.2 lbs.)
Power supply cord 2.0 m (6.6 ft)

2 4

HG6030K Heat Gun

2-speed blower settings (250 and 500 L/min) for greater versatility



Continuous rating input 1,800W
Air Temperature (°C) / Flow (L/min) Switch 1: 50 / 250
 Switch 2: 300 / 250
 Switch 3: 600 / 500
Dimensions (L x W x H) 233x80x208 mm (9-1/8"x3-1/8"x8-3/16")
Net weight 0.57 kg (1.3 lbs.)
Power supply cord 2.0 m (6.6 ft)

3 2



HG6031VK Heat Gun

2-speed blower settings (250 and 500 L/min) for greater versatility



Continuous Rating Input	1,800W
Air Temperature (°C)	High: 600 Low: 300 Medium: 50
Flow (L/min)	High: 500 Low: 250 Medium: 250
Dimensions (L x W x H)	257x85x206 mm (10-1/8"x3-3/8"x8-1/8")
Net Weight	0.67 kg (1.5 lbs)
Power Supply Cord	2.0 m (6.6 ft)



Glass protection nozzle, Reflector nozzle, Reduction nozzle, Wide slot nozzle

HG6530VK Heat Gun

Durable and powerful heat gun with variable temperature control and LCD display



Continuous rating input	2,000W
Air Temperature (°C)	50 - 650
Air Flow	Stage 1: 280 L/min Stage 2: 280 L/min Stage 3: 550 L/min
Dimensions (L x W x H)	253x85x205 mm (10"x3-3/8"x8-1/8")
Net weight	0.73 kg (1.6 lbs.)
Power supply cord	2.0 m (6.6 ft)



Glass protection nozzle, Wide slot nozzle, Reflector nozzle (Nozzle B)

HG6531CK Heat Gun

Durable and powerful heat gun with variable temperature control and LCD display



Continuous rating input	2,000W
Air Temperature (°C)	50 - 650
Air Flow	200 - 550 L/min
Dimensions (L x W x H)	257x85x206 mm (10-1/8"x3-3/8"x8-1/8")
Net weight	0.71 kg (1.6 lbs.)
Power supply cord	2.0 m (6.6 ft)



Glass protection nozzle, Wide slot nozzle, Reflector nozzle (Nozzle B)

NAILER

PRODUCTS



PT001GD201(RD2K) / GZ Cordless Pin Nailer

40Vmax XGT BL 23 GA 35 mm (1-3/8") Pin Nailer

Li-ion Ah 8.0 | 5.0 | 4.0 | 2.5 | 2.0



Capacity	Length: 15, 18, 25, 30, 35 mm (5/8, 11/16, 1, 1-3/16, 1-3/8") Dia.: 0.6 mm (1/32") Gauge: 23 Ga
Magazine Capacity	120
Dimensions (L x W x H)	218 x 86 x 226 mm (8-5/8 x 3-3/8 x 8-7/8")
Net weight	2.4 - 3.0 kg (5.3 - 6.6 lbs.)

40Vmax



Nose Adapter, Safety Goggles, Belt Clip, Hex Wrench, Battery, Charger,
Z: Battery and Charger are sold separately

DPT353RTE / Z Cordless Pin Nailer

Shoots 6,400 nails on a single full BL1860B charge

Li-ion Ah 6.0 | 5.0 | 3.0 | 1.5



Capacity	Length: 15, 18, 25, 30, 35 mm (5/8", 11/16", 1-3/16", 1-3/8") Dia.: 0.6 mm (1/32") Gauge: 23 Ga
Magazine Capacity	120
Dimensions (L x W x H)	257 x 79 x 226 mm (10-1/8" x 3-1/8" x 8-7/8")
Net weight	2.0 - 2.3 kg (4.4 - 5.1 lbs)

18V



Nose Adapter, Safety Goggles, Belt Clip, Hex Wrench, Battery, Fast Charger,
Z: Battery and Charger are sold separately



Pin Nail
(mm) **0.6** A **0.6**

Materials	Steel			
Length (A)	18 mm	25mm	30mm	35mm
Part No.	F-00013	F-00026	F-01819	F-00055
Type	P18	P25	P30	P35
Pcs/series	100pcs			
Pcs/pack	100 x 30pcs			

PT354DZ Cordless Pin Nailer

12Vmax CXT Li-Ion Cordless 23 Ga 35 mm (1-3/8") Pin Nailer

Li-ion Ah 5.0 | 4.0 | 2.0 | 1.5



Capacity	Length: 15, 18, 25, 30, 35 mm (5/8", 11/16", 1-3/16", 1-3/8") Dia.: 0.6 mm (1/32") Gauge: 23 Ga
Magazine Capacity	120
Dimensions (L x W x H)	231x66x226 mm (9-1/8"x2-5/8"x8-7/8")
Net weight	1.8 - 2.0 kg (4.0 - 4.4 lbs.)

12Vmax

Nose Adapter, Safety Goggles, Belt Clip, Hex Wrench, Battery, Charger, DZ: Battery and Charger are sold separately

FN001GD101(RDK) / GZ Cordless Brad Nailer

40Vmax XGT BL Cordless 18 Ga 40 mm (1-5/8") Brad Nailer

Li-ion Ah 5.0 | 4.0 | 2.5 | 2.0



Capacity	Length: 15 - 40 mm (5/8" - 1-5/8") Gauge: 18 Ga
Magazine Capacity	100
Shot q'ty on a single full battery charge	w/ BL4025: 4,000
Dimensions (L x W x H)	w/ BL4025: 265 x 83 x 244 mm (10-3/8 x 3-1/4 x 9-5/8") w/ BL4040: 271 x 100 x 244 mm (10-5/8 x 3-15/16 x 9-5/8")
Net weight	2.6 - 2.9 kg (5.7 - 6.4 lbs.)

FN001GD101
FN001GZ

40Vmax

Safety Goggles, Nose Adapter, Hex Wrench, Belt Clip, Battery, Charger, Z: Battery and Charger are sold separately

DFN350ZJ Cordless Brad Nailer

18V LXT Li-Ion Cordless 18 Ga 35 mm (1-3/8") Brad Nailer

Li-ion Ah 6.0 | 5.0 | 3.0 | 1.5



Capacity	Length: 15 - 35 mm (5/8" - 1-3/8") Gauge: 18 Ga
Magazine Capacity	110
Dimensions (L x W x H)	w/ BL1815N / BL1820B: 240x79x228 mm (9-1/2"x3-1/8"x9") w/ BL1830B / BL1840B / BL1850B / BL1860B: 257x79x228 mm (10-1/8"x3-1/8"x9")
Net weight	2.1 - 2.4 kg (4.6 - 5.3 lbs.)

18V

Safety Goggles, Nose Adapter, Hex Wrench, Belt Clip, Battery, Charger, Z: Battery and Charger are sold separately

AF301 Pneumatic Nailer

Application: Decoration, Picture Frame, Furniture, Shoe-Making, Drawer Assembly



Capacity -	Length 10-30mm (13/32" - 1-3/16")
Width 1.25 mm (0.05")	
Wire 1.05 mm (0.041")	
Gauge 18 Ga	
Tank Max Pressure 0.39-0.69 MPa (60-100 PSI)	
Net Weight 1.3 kg (2.86 lbs)	

With Safety Pin Preventing Accident Operation, Oil, Hex Wrench

AF506 50mm (2") Pneumatic Brad Nailer

16 GA Pneumatic Finish Nailer, Air Duster



Capacity -	Length 15 - 50 mm (5/8" - 2")
Gauge 18 Ga	
Operating Pressure 0.49 - 0.83 MPa (70 - 120 PSI)	
Magazine Capacity 100	
Dimensions (L x W x H) 250x70x256 mm (9-7/8"x2-3/4"x10-1/8")	
Net Weight 1.3 kg (2.9 lbs.)	

Safety Goggles, Oil supply, Nose Adapter, Hook

ST002GZ Cordless Stapler **New**

40Vmax XGT Cordless 10 mm J Wire Stapler

Li-ion Ah 8.0 | 5.0 | 4.0 | 2.5 | 2.0



Staple	Width: 10 mm Length: 13 - 25 mm (1/2" - 1") Size: 1.2 x 0.6 mm
Magazine capacity	100
Shot q'ty on a single full battery charge	w/ BL4025: 6,000
Dimensions (L x W x H)	w/ BL4025: 269 x 86 x 216 mm (10-5/8"x3-3/8"x8-1/2")
Net weight	2.5 - 3.7 kg (5.7 - 8.2 lbs.)

40Vmax

Nose adapter, Belt clip, Battery, Charger, Z: Battery and Charger are sold separately



DST121ZK Cordless Stapler

18V LXT Li-Ion Cordless 10 mm J Wire Stapler

Li-ion Ah 6.0 5.0 3.0 1.5



Staple	Width: 10 mm Length: 13 - 25 mm (1/2" - 1") Size: 1.2 x 0.6 mm
Magazine capacity	100
Shot q'ty on a single full battery charge	w/BL1860B: 4,800
Dimensions (L x W x H)	w/BL1815N: 244x79x216 mm (9-5/8"x3-1/8"x8-1/2") w/BL1830B / BL1850B / BL1860B: 260x79x216 mm (10-1/4"x3-1/8"x8-1/2")
Net weight	2.2 - 2.5 kg (4.9 - 5.5 lbs.)

18V **LXT XPT**

Safety Goggles, Nose Adapter, Belt Clip, Battery, Charger, Z: Battery and Charger are sold separately

DST221Z Cordless Stapler

Machined aluminum magazine ensures smooth staple loading and feeding

Li-ion Ah 6.0 5.0 3.0 1.5



Staple	Width: 10 mm (3/8") Length: 10, 13, 16, 19, 22 mm (3/8"; 1/2"; 5/8"; 3/4"; 7/8") Gauge: 0.6 x 1.2 mm (1/32" x 1/16")
Magazine Capacity	98
Sound Power Level	93 dB(A)
Dimensions (L x W x H)	251x91x212 mm (9-7/8"x3-5/8"x8-3/8")
Net weight	2.1 - 2.4 kg (4.7 - 5.3 lbs)

18V **LXT** 5

Safety Goggles, Z: Battery and Charger are sold separately

DST421ZK Cordless Stapler

18V LXT Li-Ion Cordless 4 mm J Wire Stapler

Li-ion Ah 6.0 5.0 3.0 1.5



Staple	Width: 4 mm Length: 13 - 25 mm (1/2" - 1") Size: 1.2 x 0.6 mm
Magazine capacity	100
Shot q'ty on a single full battery charge	w/BL1860B: 4,800
Dimensions (L x W x H)	w/BL1815N: 244x79x216 mm (9-5/8"x3-1/8"x8-1/2") w/BL1830B / BL1850B / BL1860B: 260x79x216 mm (10-1/4"x3-1/8"x8-1/2")
Net weight	2.2 - 2.5 kg (4.9 - 5.5 lbs.)

18V **LXT XPT**

Safety Goggles, Nose Adapter, Belt Clip, Battery, Charger, Z: Battery and Charger are sold separately

AT1022AZ Pneumatic Stapler

Application: Cabinet Making, Case back Assembly, Drawer Assembly, Furniture



Capacity - Length	10 - 22 mm (13/32" - 7/8")
Gauge	18 Ga
Magazine Capacity	100
Operating Pressure	0.45 MPa (65 PSI)
Dimensions (L x W x H)	250x55x180 mm (9-3/4"x2-1/4"x7")
Net Weight	1.3 kg (2.86 lbs)

10

With Safety Pin Preventing Accident Operation, Oil, Hex Wrench

SPECIALITY TOOLS

PRODUCTS



DRV250Z Cordless Rivet Gun

18V LXT BL Brushless Cordless Rivet Gun

Li-ion Ah 6.0 5.0 3.0 1.5



Max pulling force	20 kN
Length of Stroke	30 mm (1-3/16")
Center height	26 mm (1")
Sound Pressure Level	74 dB(A)
Vibration Level	2.5 m/s ² or less
Dimensions (L x W x H)	w/BL1830B / BL1850B / BL1860B: 320x80x287 mm (12-5/8"x3-1/8"x11-1/4")
Net weight	2.1 - 2.4 kg (4.6 - 5.3 lbs.)

18V **LXT BL XPT** 1

Hook, Grease, Accessory Set, Battery, Charger, Z: Battery and Charger are sold separately

DGP180Z Cordless Grease Gun

Powerful motor delivers up to 69 MPa (10,000 PSI) of max pressure

Li-ion Ah 6.0 5.0 3.0 1.5



Max Operating Pressure	69 MPa (10,000 PSI)
Flow Rate	Slow Speed Mode: 145 mL/min (5.0 oz/min) Auto Speed Change Mode: 290 mL/min (10.0 oz/min)
Grease Capacity w/ Barrel A	Cartridge / Bulk: 410 / 455 g
Grease Capacity w/ Barrel B	Cartridge / Bulk: 450 / 570 g
Hose Length	120 cm (47-1/4")
Dimensions (L x W x H)	w/ Barrel A: 411x114x245 mm (16-1/4"x4-1/2"x9-5/8") w/ Barrel B: 449x114x245 mm (17-3/4"x4-1/2"x9-5/8")
Net weight	4.8 - 6.1 kg (10.6 - 13.4 lbs.)

18V **LXT**

Shoulder Strap, Battery, Charger, Z: Battery and Charger are sold separately

DVP181ZK Cordless Vacuum Pump

Long run time of 50 minutes with a fully charged BL1850B (5.0Ah)

Li-ion Ah 6.0 | 5.0 | 3.0 | 1.5



Flow rate	113 L/min
Ultimate vacuum	3 Pa
Motor speed	3,200 min ⁻¹
Oil Tank Capacity	300 mL
Inlet port	5/16" / 3/8"
Dimensions (L x W x H)	383 x 193 x 210 mm (15-1/8" x 7-5/8" x 8-1/4")
Net weight	8.1 - 8.2 kg (17.9 - 18.1 lbs.)

18V



Vacuum Pump Oil, Adapter, Battery, Charger, Z: Battery and Charger are sold separately

DVP180Z Cordless Vacuum Pump

Long run time of 50 minutes with a fully charged BL1850B (5.0Ah)

Li-ion Ah 6.0 | 5.0 | 3.0 | 1.5



Flow rate	50 L/min
Ultimate vacuum	20 Pa (150 microns)
Motor speed	3,840 min ⁻¹
Oil Tank Capacity	115 mL
Inlet port	5/16"
Dimensions (L x W x H)	265x93x175 mm (10-3/8"x3-5/8"x6-7/8")
Net weight	3.5 kg

18V



Pump oil, Adapter, Battery, Fast Charger, Z: Battery and Charger are sold separately

AC001GZ Cordless Air Compressor

New

Developed mainly for interior nailing applications e.g. finish nailing with 18 Ga nail

Li-ion Ah 8.0 | 5.0 | 4.0 | 2.5 | 2.0



Tank	7.6 L (2 gal)
Cut-In Pressure	0.72 MPa (105 PSI)
Cut-Out Pressure	0.93 MPa (135 PSI)
Number of Outlets	1
Performance	34.0 L/min
Noise Level	68 dB(A)
Dimensions (L x W x H)	302x434x382 mm (11-7/8" x 17-1/8" x 15")
Net weight	11.6 - 12.8 kg (25.6 - 28.2 lbs.)

40Vmax



Z: Battery and Charger are sold separately

DTR181Z Cordless Rebar Tying Tool

18V LXT BL Brushless Cordless Rebar Tying Tool

Li-ion Ah 6.0 | 5.0 | 3.0 | 1.5



Tie Wire	ø0.8 mm
Applicable Rebars	D16 x D16 - [D13 x 2] x [D16 x 2] w/ BL1830B / BL1850B / BL1860B:
Dimensions (L x W x H)	317 x 93 x 318 mm (12-1/2 x 3-5/8 x 12-1/2")
Net weight	2.4 - 2.7 kg (5.3 - 6.0 lbs.)

18V



Nylon brush, Hex Wrench, Hook, Z: Battery and Charger are sold separately

DTC100ZK (Close Type) Cordless Cable Cutter

New

Closed type for precision cutting

Li-ion Ah 6.0 | 5.0 | 3.0 | 1.5



Max. cutting diameter	50 mm (2")
Max cable cutting capacity	1600V-CV: 500mm ² single-core (38mm (1-1/2)), 6600V-CV: 500mm ² single-core (45mm (1-3/4)), 600V-IV: 500mm ² single-core (35mm (1-3/8)), 600V-VVR: 150mm ² triple-core (47mm (1-7/8))
Dimensions (L x W x H)	w/BL1830B / BL1850B / BL1860B: 116 x 197 x 363 mm (4-9/16 x 7-3/4 x 14-1/4")
Net weight	2.9 kg (6.4 lbs.)

18V



Blade, Z: Battery and Charger are sold separately



DTC101ZK (Open Type) Cordless Cable Cutter

New

Open type for easy cutting of cable at desired position

Li-ion Ah 6.0 | 5.0 | 3.0 | 1.5



Max. cutting diameter	50 mm (2")
Max cable cutting capacity	600V-CV: 500mm ² single-core (38mm (1-1/2)), 6600V-CV: 500mm ² single-core (45mm (1-3/4)), 600V-IV: 500mm ² single-core (35mm (1-3/8)), 600V-VVR: 150mm ² triple-core (47mm (1-7/8))
Dimensions (L x W x H)	w/BL1830B / BL1850B / BL1860B: 116 x 190 x 430 mm (4-9/16 x 7-1/2 x 17")
Net weight	3.6 kg (7.9 lbs.)

18V



Blade, Z: Battery and Charger are sold separately

DTM52RTJX2 / Z Cordless Multi Tool

Tool-less accessory clamp for quick installation and replacement

Li-ion Ah 6.0 | 5.0 | 3.0 | 1.5



Oscillations Per Minute (OPM)	10,000 - 20,000
Oscillation Angle	Left / Right / Total: 1.8° / 1.8° / 3.6°
Dimensions (L x W x H)	w/BL1830B / BL1850B / BL1860B: 322 x 95 x 126 mm (12-5/8 x 3-3/4 x 5")
Net weight	1.7 - 2.0 kg (3.7 - 4.4 lbs.)

18V



Oscillating Multi Tool Accessories, Dust Attachment (country-specific), Tool Box (country-specific), Battery, Charger, Z: Battery and Charger are sold separately

Extra versatility

DTM52 Compatible with STARLOCK MAX accessories



STARLOCK MAX



Cutting plasterboards



Deep plunge cutting



Wood flush cutting



Pocket cutting



Cutting PVC, FRP pipes



Routing joints on wall tiles



Removal of window frame



Door opening work



Cutting metals



Copper pipe flush cutting



Cutting window putty, silicone



Sanding and polishing

DTM51Z Cordless Multi Tool

Tool-less accessory clamp for quick installation and replacement

Li-ion Ah 6.0 | 5.0 | 3.0 | 1.5



Oscillations Per Minute (OPM)	6,000 - 20,000
Oscillation Angle	Left / Right / Total: 1.6° / 1.6° / 3.2°
Sound Power Level	Plunge Saw Blade: 92 dB(A) Scraping: 91 dB(A)
Dimensions (L x W x H)	340x80x122 mm (13-3/8"x3-1/8"x4-13/16")
Net weight	2.0 - 2.4 kg (4.4 - 5.3 lbs)

18V



Fast Charger, Battery Cartridge, Hex Wrench, Z: Battery and Charger are sold separately

TM3010CX6 Multi Tool

320 W Toolless Multi Tool

459 mm



Continuous rating input	320W
Strokes Per Minute (SPM)	6,000 - 20,000
Dimensions (L x W x H)	283 x 68 x 87 mm (11-1/8 x 2-1/16 x 3-7/16")
Net weight	1.6 - 1.7 kg (3.7 - 3.9 lbs.)
Power supply cord	2.5 m (8.2 ft)



Oscillating Multi Tool Accessories

CP100DSA / DZ Cordless Multi Cutter

12Vmax CXT Li-Ion Cordless Multi Cutter

Li-ion Ah 5.0 | 4.0 | 2.0 | 1.5



Max Cutting Capacity	6 mm (1/4")
No Load Speed (RPM)	300
Vibration Level	Cutting Cardboard: 2.5 m/s ² or less
Dimensions (L x W x H)	272x66x120 mm (10-3/4"x2-5/8"x4-3/4")
Net Weight	0.72 - 0.88 kg (1.6 - 1.9 lbs)

CP100DSA CP100DZ

12Vmax



Blade, Battery, Charger, DZ: Battery and Charger are sold separately

DCG180ZB Cordless Caulking Gun

18V LXT Li-Ion Cordless Caulking Gun

Li-ion Ah 6.0 | 5.0 | 3.0 | 1.5



Max Dispensing Force	5,000 N (1,100 lbs)
No load speed	0 - 28 mm/sec. (0 - 66 in./min.)
Holder Size	300, 600, 800 mL
Dimensions (L x W x H)	404x108x281 mm (15-7/8"x4-1/4"x11-1/8")
Net weight	2.1 - 3.0 kg (4.7 - 6.6 lbs)

18V



Fast Charger, Battery Cartridge, Holder, Holder Joint, Piston, Rubber Ring, Nozzle, Z: Battery and Charger are sold separately

CG100DZA Cordless Caulking Gun

12Vmax CXT Li-Ion Cordless Caulking Gun

Li-ion Ah 5.0 | 4.0 | 2.0 | 1.5



Max Dispensing Force	5,000 N (1,100 lbs)
No load speed	0 - 28 mm/sec. (0 - 66 in./min.)
Holder Size	300, 600, 800 mL
Dimensions (L x W x H)	404x108x259 mm (15-7/8"x4-1/4"x10-1/4")
Net weight	1.9 - 2.6 kg (4.2 - 5.8 lbs)

12Vmax



Holder, Holder Joint, Piston, Rubber Ring, Nozzle, Battery, Charger, DZ: Battery and Charger are sold separately

MP001GZ Cordless Inflator

3 Inflation modes (High speed, Low speed or Ball modes)

Li-ion Ah 8.0 | 5.0 | 4.0 | 2.5 | 2.0



Air Discharge Amount	200 kPa: 24 L/min 700 kPa: 12 L/min
Max Air Pressure	1,110 kPa (161 PSI) [11.1 bar]
Hose Length	65 cm (25-1/2")
Sound Pressure	71 dB(A)
Dimensions (L x W x H)	w/BL4020/BL4025: 320 x 108 x 231 mm (12-5/8 x 4-1/4 x 9-1/8"), w/BL4040: 329 x 108 x 231 mm (13 x 4-1/4 x 9-1/8"), w/BL4050F: 351 x 108 x 231 mm (13-3/4 x 4-1/4 x 9-1/8")
Net Weight	2.9 - 3.5 kg (6.4 - 7.7 lbs.)

40Vmax



British Adapter, French Adapter, Ball Adapter, Swim Ring Adapter, Battery, Charger, Z: Battery and Charger are sold separately

DMP180Z Cordless Inflator

18V max LXT Li-Ion Cordless Inflator

Li-ion Ah 6.0 | 5.0 | 3.0 | 1.5



Max Air Pressure 830 kPa (121 PSI)
 Air Discharge amount 200 kPa: 10 L/min
 Dimensions (L x W x H) w/ BL1830B / BL1850B / BL1860B: 270x76x175 mm (10-5/8"x3"x6-7/8")
 Net weight 1.5 - 1.8 kg (3.3 - 4.0 lbs.)

18V 4

British Adapter, French Adapter, Ball Adapter, Swim Ring Adapter, Battery, Charger, Z: Battery and Charger are sold separately

MP100DZ Cordless Inflator

12Vmax CXT Li-Ion Cordless Inflator

Li-ion Ah 5.0 | 4.0 | 2.0 | 1.5



Max Air Pressure 830 kPa
 Air Discharge amount 200kPa: 10 L/min
 Dimensions (L x W x H) w/ BL1016/BL1021B: 235x74x173 mm (9-1/4"x2-15/16"x6-13/16") w/ BL1041B: 255x74x173 mm (10"x2-15/16"x6-13/16")
 Net weight 1.2 - 1.3 kg (2.6 - 3.0 lbs.)

12Vmax 4

Valve adapter, Ball adapter, Floating tube adapter, DZ: Battery and Charger are sold separately

MEASURING/LEVELING

PRODUCTS



SK10GDZ Rechargeable Green Multi Line Laser

Bright green laser for increased visibility

Li-ion Ah 5.0 | 4.0 | 2.0 | 1.5



Leveling Accuracy ± 1 mm / 10 m
 Self-Leveling Range $\pm 4^\circ$
 Laser Fan Angle Horizontal: 110°
 Vertical: 130°
 Laser line selection 4V1H / 2V1H / 1V1H
 Laser Type Laser class 2: 515 nm
 Operating Temperature $-10 - 40^\circ\text{C}$
 Protection class IP54
 Operating Time BL1016: 12 hours
 Dimensions w/ BL1016/BL1021B: (L x W x H) 98x223 mm
 Net Weight 1.4 - 1.6 kg (3.1 - 3.5 lbs)

12Vmax 6

Laser detector, Laser Receiver Vise, Laser Viewing Glass, Shoulder Strap, Storage Case, Battery, DZ: Battery and Charger are sold separately

Green Laser Series

Powered by the following 12V max slide CXT Li-ion batteries

SK40GD / SK10GD

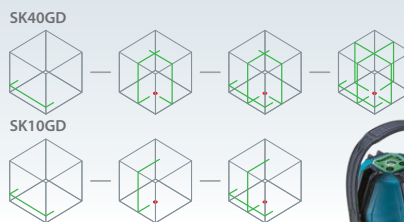

Continuous runtime SK40GD / SK10GD

6 / 9 / 12 h
 BL1016 Normal

12 / 16 / 20 h
 BL1016 Eco mode

Leveling accuracy ± 1 mm / 10 m



SK40GDZ Rechargeable Green Multi Line Laser

Bright green laser for increased visibility

Li-ion Ah 5.0 | 4.0 | 2.0 | 1.5



Leveling Accuracy ± 1 mm / 10 m
 Self-Leveling Range $\pm 4^\circ$
 Laser Fan Angle Horizontal: 110°
 Vertical: 130°
 Laser line selection 4V1H / 2V1H / 1V1H
 Laser Type Laser class 2: 515 nm
 Operating Temperature $-10 - 40^\circ\text{C}$
 Protection class IP54
 Operating Time BL1016: 6 hours
 Dimensions w/ BL1016/BL1021B: (L x W x H) 98x223 mm
 Net Weight 1.4 - 1.6 kg (3.1 - 3.5 lbs)

12Vmax 6

Laser detector, Laser Receiver Vise, Laser Viewing Glass, Shoulder Strap, Storage Case, Battery, DZ: Battery and Charger are sold separately

SK700GD Rechargeable Green / Red Multi Line Laser

3 x full 360-degree lines for quick and easy setup

Li-ion Ah 5.0 | 4.0 | 2.0 | 1.5



Leveling accuracy ± 2 mm / 10 m
 Self-leveling rang $\pm 4^\circ$
 Laser type SK700GD: Laser class 2: 510 - 530 nm
 SK700D: Laser class 2: 630 - 645 nm
 Operating Temperature $-10 - 50^\circ\text{C}$
 Protection class IP54
 Dimensions (L x W x H) w/ BL1016/BL1021B: 149 x 104 x 153 mm (5-7/8 x 4-1/8 x 6") w/ BL1041B: 168 x 104 x 153 mm (6-5/8 x 4-1/8 x 6")
 Net weight 0.99 - 1.2 kg (2.2 - 2.7 lbs.)

12Vmax 7

Target Plate, Adapter, Soft Bag, DZ: Battery and Charger are sold separately

SK105GDZ Rechargeable Green / Red Cross Line Laser

High brightness green laser for increased visibility at bright site

Li-ion Ah 5.0 | 4.0 | 2.0 | 1.5



Measuring range	Up to: 35 m
Measuring range w/detector	Up to: 80 m
Leveling accuracy	±3 mm / 10 m
Self-leveling range	±4°
Number of laser lines	2
Laser type	Laser class 2: 525 nm
Operating temperature	-10 - 50 °C
Operating Time (Approx. Hrs)	7 - 20
Dimensions (L x W x H)	w/ BL1016/BL1021B: 1138x64x102 mm w/ BL1041B: 157x64x102 mm
Net weight	0.67 - 0.84 kg

12Vmax



10

Soft bag, Adapter, Target Plate, DZ: Battery and Charger are sold separately

LD030P 30m Laser Distance Measure

Measuring accuracy and productivity



Measuring Range	0.2-30m
Operating Temperature	0 - 40°C
Storage Temperature	-25 - 70°C
Typical Measuring Tolerance	±2.0mm / 10m
Max Measuring Tolerance	±3.0mm / 10m
Diameter Of Laser Point	6mm / 10m
Laser Type	Laser class 2: 635nm
Dimensions (H x D x W)	117x53x25mm (4.5"x2.14"x1")
Net Weight	0.1kg (0.22lbs)

20

Alkaline Battery (2), Carrying Strap

LD050P 50m Laser Distance Measure

Measuring accuracy and productivity



Measuring Range	0.05-50m
Power Supply	Cell battery: AAA 1.5V x 2pcs
Net Weight	0.1kg (0.22lbs)

10

Alkaline Battery (2), Carrying Strap Front Cuffs 24, Poly Bag Set

LD080P 80m Laser Distance Measure

Measuring accuracy and productivity



Measuring Range	0.05-80m
Power Supply	Cell battery: AAA 1.5V x 2pcs
Net Weight	0.14kg (0.31lbs)

10

Alkaline Battery (2), Carrying Strap

COMFORT/ LIFESTYLE

PRODUCTS



CF003GZ 450mm (17-3/4") Cordless Fan

New

40Vmax XGT / 18V LXT Li-Ion Cordless 450 mm (17-3/4") Fan

Li-ion Ah 8.0 | 5.0 | 4.0 | 2.5 | 2.0



Air velocity	96-300 m/min
Air flow	38-120 m ³ /min
Fan diameter	450 mm (17-3/4")
Fan head angle adjustment	Up: 90° / Down: 45° Left: 90° / Right: 90°
Automatic oscillation	Left: 60, 90, 120° Right: 60, 90, 120°
Continuous use (min.) w/o oscillation	w/ BL4040: 115 / w/ BL4080F: 230 / w/ BL1860B: 90
Dimensions (L x W x H)	w/o Battery: 312 x 633 x 770 mm (12-1/4 x 25 x 30-1/4") w/o Battery: 7.9 kg (17.4 lbs.)
Net weight	

40Vmax 18V



1

AC Adaptor, Z: Battery and Charger are sold separately

CF002GZ 330mm (13") Cordless Fan

Increased max air velocity 240 m/min

Li-ion Ah 8.0 | 5.0 | 4.0 | 2.5 | 2.0



Continuous Use (min.) w/o oscillation	w/ BL4040: Low / Mid / High: 1,020 / 640 / 320
Continuous Use (min.) w/ oscillation	w/ BL4040: Low / Mid / High: 970 / 610 / 305
Max Air Velocity	High / Mid / Low: 240 / 170 / 120 m/min
Air Flow	High / Mid / Low: 21 / 15 / 10 m ³ /min
Noise level	52 dB(A)
Fan Diameter	330 mm (13")
Dimensions (L x W x H)	w/ BL4040: 277 x 439 x 602 mm
Net weight	3.8 - 5.1 kg (8.4 - 11.2 lbs.)

40Vmax



1

AC Adaptor, Z: Battery and Charger are sold separately



450 mm fan diameter

Max air flow volume
120
m³ / min

Max air speed*
300
m / min
*Measured at 1.0 m away from the appliance

photo: CF003G

Compatible with

- 40Vmax XGT Li-Ion battery
- 18V LXT Li-Ion battery
- AC (through AC adapter)

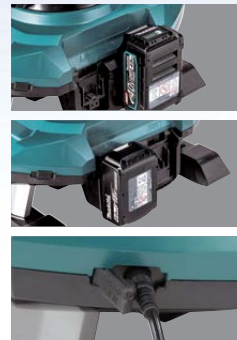

Manual angle adjustment of fan head



90° up/45° down with a locking knob

Automatic oscillation



Automatic oscillation angle adjustment: 60°, 90°, 120° left/right

Three Off timer settings

1 hour, 2 hours, 4 hours



CF001GZ 235 mm (9-1/4") Cordless Fan

40Vmax XGT Automatic Swing Fan

Li-ion Ah 5.0 | 4.0 | 2.5 | 2.0



40Vmax XGT 3

AC Adaptor, Z: Battery and Charger are sold separately

Continuous Use (min.) w/o oscillation	w/ BL4040 Low / Mid / High: 1,160 / 880 / 660 w/ BL4025 Low / Mid / High: 730 / 550 / 410
Continuous Use (min.) w/ oscillation	w/ BL4040 Low / Mid / High: 1,055 / 800 / 600 w/ BL4025 Low / Mid / High: 665 / 500 / 370
Max Air Velocity	High / Med / Low: 190 / 150 / 120 m/min
Air Flow	High / Med / Low: 8.2 / 6.5 / 5.2 m ³ /min 143x333x463 mm (5-5/8"x13"x18-1/4")
Dimensions (L x W x H)	
Net weight	2.0 - 3.0 kg (4.4 - 6.6 lbs.)

DCF301Z 330mm (13") Cordless Fan

Increased max air velocity 240 m/min

Li-ion Ah 6.0 | 5.0 | 3.0 | 1.5



18V 14.4V XGT 1

AC Adaptor, Z: Battery and Charger are sold separately

Continuous Use (min.) w/o oscillation	w/ BL1860B: Low / Mid / High: 850 / 430 / 215
Continuous Use (min.) w/ oscillation	w/ BL1860B: Low / Mid / High: 815 / 415 / 210
Max Air Velocity	High / Mid / Low: 240 / 170 / 120 m/min
Air Flow	High / Mid / Low: 21 / 15 / 10 m ³ /min
Noise level	52 dB(A)
Fan Diameter	330 mm (13")
Dimensions (L x W x H)	w/ BL1860B: 269 x 439 x 602 mm
Net weight	3.8 - 4.5 kg (8.4 - 9.9 lbs.)

DCF203Z 235 mm (9-1/4") Cordless Fan

Automatic Swing Fan

Li-ion Ah 6.0 | 5.0 | 3.0 | 1.5



18V 14.4V XGT 3

Z: Battery and Charger are sold separately

Max Continuous Use (min.)	w/ BL1860B: Low / Medium / High: 1,010 / 650 / 410
Max Air Velocity	High / Med / Low: 190 / 150 / 120 m/min
Air Flow	High / Med / Low: 8.2 / 6.5 / 5.2 m ³ /min 140x333x447 mm (5-1/2"x13"x16-1/2")
Dimensions (L x W x H)	
Net weight	1.9 - 2.6 kg (4.2 - 5.6 lbs.)

DCF102ZX1 180 mm (7-1/8") Cordless Fan

Automatic Swing Fan

Li-ion Ah 6.0 | 5.0 | 3.0 | 1.5



18V XGT 4

Z: Battery and Charger are sold separately

Max Continuous Use (min.)	w/ BL1860B: Low / Medium / High: 1270 / 705 / 575
Dimensions (L x W x H)	185x272x284 mm (7-1/4"x10-3/10"x11-1/8")
Net weight	1.3 - 2.0 kg (2.9 - 4.4 lbs.)

CW002GZ Cordless Cooler & Warmer Box

Large 50 L capacity

Li-ion Ah 8.0 | 5.0 | 4.0 | 2.5 | 2.0



40Vmax 18V XGT LXT 3

Cigar Socket Cable, Z: Battery and Charger are sold separately

Capacity	50L (13.2 gal)
Cooling Capacity	-18/-15/-10/-5/0/5/10°C (0/5/15/25/30/40/50°F)
Warming System	30/35/40/45/50/55/60°C (85/95/105/115/120/130/140°F)
Run Time	w/BLBL4040, -18/5/60°C: 8 / 19.5 / 4.5
Cord Length	AC Adapter / Cigar Socket Cable: 2 / 2.5 m (6.5 / 8.2 ft)
Storage dimensions (L x W x H)	500 x 320 x 320 mm (19-3/4 x 12-5/8 x 12-5/8")
Dimensions (L x W x H)	867 x 465 x 476 mm (34-1/8 x 18-1/4 x 18-3/4")
Net weight	25.6 - 29.0 kg (56.4 - 63.9 lbs.)

CW004GZ Cordless Cooler & Warmer Box

New

A combination of XGT battery and LXT battery is also accepted

Li-ion Ah 8.0 | 5.0 | 4.0 | 2.5 | 2.0



40Vmax 18V XGT LXT 3

Shoulder belt, AC adaptor, Cigar socket cable, Inner tray, Inner basket, Z: Battery and Charger are sold separately

Capacity	29L (7.7 gal)
Cooling System	-18°C (0°F)
Warming System	60°C (140°F)
Temperature setting	17 settings: -18/-15/-10/-5/0/5/10/15/20/25/30/35/40/45/50/55/60°C
Run Time	w/BL4050F x2, -18/5/60°C: 12.5/30.0/11.5
Cord Length	AC Adapter / Cigar Socket Cable: 2.2 / 2.5 m (7.2 / 8.2 ft)
Storage Dimensions (L x W x H)	343 x 240 x 338 mm (26-5/8 x 13-5/8 x 18-1/2")
Dimensions (L x W x H)	676 x 345 x 471 mm (26-5/8 x 13-5/8 x 18-1/2")
Net weight	7.5 - 20.9 kg (38.6 - 46.1 lbs.)



Top cover that can be opened from both sides

Work amount on full battery charge with two BL4050F batteries / When used as one room

-18°C [0°F] about **12.5 h** | 5°C [40°F] about **30 h** | 60°C [140°F] about **11.5 h**

29 L (7.7gal)

Dual room mode is available by using the partition plate.

17 inside temperature settings

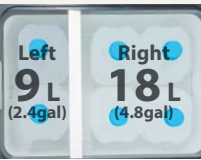

photo: CW004G

CW001GZ Cordless Cooler & Warmer Box

Powered by 4 sources: 40Vmax / 18V / 12V/24V DC (cigar socket) / AC

Li-ion Ah 8.0 | 5.0 | 4.0 | 2.5 | 2.0



Capacity	20L (5.3gal)
Cooling System	Compressor type
Cooling Capacity	-18/-15/-10/-5/0/5/10°C
Warming System	Heater
Warming Capacity	30/35/40/45/50/55/60°C
Run Time	w/BL4050F X2, -18°C/5°C/60°C: 10h/28h/8.5h
Cord Length	AC Adapter / Cigar Socket Cable: 2/2.5m (6.5/8.2ft)
Dimensions (L x W x H)	663x341x372mm (26-1/8x13-3/8x14-5/8")
Net weight	13.5-16.1kg (29.8-35.5 lbs.)

40Vmax 18V XGT LXT 2.0Ah

Shoulder Belt, Cigar Socket Cable, Z: Battery and Charger are sold separately

CW003GZ Cordless Cooler & Warmer Box

Compact design, 7 L capacity

Li-ion Ah 8.0 | 5.0 | 4.0 | 2.5 | 2.0



Capacity	7L (1.8gal)
Cooling System	Compressor type
Cooling Capacity	-18/-15/-10/-5/0/5/10°C
Warming System	Heater
Warming Capacity	30/35/40/45/50/55/60°C
Run Time	w/BLBL4040, -18/5/60°C: 5.5/13.5/5.5
Cord Length	AC Adapter / Cigar Socket Cable: 2/2.5m (6.5/8.2ft)
Dimensions (L x W x H)	456 x 245 x 308 mm (18 x 9-5/8 x 12-1/8")
Net weight	7.9-9.4kg (17.4-20.7 lbs.)

40Vmax 18V XGT LXT 2.0Ah

Shoulder Belt, Cigar Socket Cable, Z: Battery and Charger are sold separately

MW001GZ Cordless Microwave

New

Excellent portability

Li-ion Ah 8.0 | 5.0 | 4.0 | 2.5 | 2.0



Useful cavity dimensions (W x D x H)	255 x 241 x 120 mm (10 x 9-1/2 x 4-3/4")
Cavity capacity	8 L
Microwave power	High / Low: 500 / 350 W
Operating frequency	2,450 MHz
Continuous run time on full battery charge (350 / 500 W)	w/BL4020 x2: 11 / 6 min., w/BL4025 x2: 14 / 8 min., w/BL4040 x2: 21 / 15 min., w/BL4050F x2: 30 / 22 min., w/BL4080F x2: 48 / 35 min., w/PDC1200: 113 / 84 min.
Dimensions (L x W x H)	w/o Battery: 318 x 343 x 338 mm (12-1/2 x 13-1/2 x 13-1/4")
Net weight	w/o Battery: 8.9 kg (19.6 lbs.)

40Vmax XGT

Z: Battery and Charger are sold separately

Popular size food container can be heated.



photo: MW001G

Cavity capacity **8 L**

Control panel

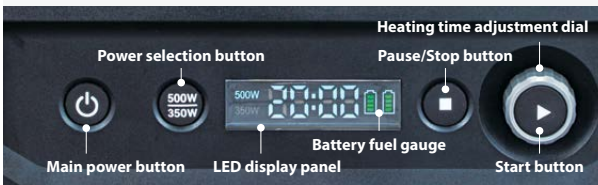

Approx number of times an item can be heated

With two fully charged BL4040 batteries

food container of chilled items **5 times**

mug of drink (200mL) **8 times**

Continuous heating time on a full battery charge (approx)

500w: 35 min*

Battery: BL4080F x2

* This is the total time of repeated maximum 8-minute continuous heating at 500W in temporary boost mode



1. Stops heating promptly and automatically when tilted.



2. Stops heating promptly and automatically when the door is opened during heating.



3. Reminder beep for items left in the cavity





MR006G Job Site Radio

12Vmax-40Vmax CXT LXT XGT Li-Ion Cordless Bluetooth Job Site Radio

Li-ion Ah 8.0 5.0 4.0 2.5 2.0



Frequency Band	FM / AM: 87.5 - 108 MHz / 522 - 1,710 kHz
Speaker Size	Sides: Dia. 63.5 mm x 2 Bottom: Dia. 101.6 mm
Max Output	40Vmax: 5W x 2 + 25W / 18V: 5W x 2 + 25W / 14.4V: 3W x 2 + 15W / 12Vmax: 2W x 2 + 10W
Bluetooth	Version: 5.0 Profile: A2DP / SCMS-T / AVRCP Supported Codec: SBC Max Transmission Range: 10 m (33 ft)
Dimensions (L x W x H)	w/ Handle in Retracted Position: 285 x 172 x 305 mm
Net weight	5.6-6.4 kg (12.3 - 14.1 lbs.)

Bluetooth

40Vmax 18V 14.4V 12Vmax 10.8V



AC Adaptor, AA Battery

MR002G Job Site Radio

12Vmax-40Vmax CXT LXT XGT Li-Ion Cordless Bluetooth Job Site Radio

Li-ion Ah 8.0 5.0 4.0 2.5 2.0



Frequency Band	FM / AM: 87.5 - 108 MHz / 522 - 1,710 kHz
Speaker Size	Woofer: Dia. 89 mm x 2
Max Output	40Vmax: 3.5 W x 2
Bluetooth	Version: 5.0 Profile: A2DP / SCMS-T Supported Codec: SBC Max Transmission Range (Optimum): 10 m (33 ft) w/ Handle in Upright Position: 280 x 171 x 434 mm (11 x 6-3/4 x 17-1/8")
Dimensions (L x W x H)	
Net weight	4.6 - 5.4 kg (10.1 - 11.9 lbs.)

Bluetooth

40Vmax 18V 14.4V 12Vmax 10.8V



AC Adaptor, AA Battery

DMR300 Job Site Radio

12Vmax-18V CXT LXT Li-Ion Cordless Bluetooth Job Site Charger Radio

Li-ion Ah 6.0 5.0 3.0 1.5



Frequency Band	FM / AM: 87.5 - 108 MHz / 520 - 1,710 kHz
Speaker Size	Woofer: Ø89 mm x 2
Bluetooth	Version: 4.2 Max Transmission Range (Optimum): 30 m (98 ft)
Dimensions (L x W x H)	285 x 185 x 305 mm (11-1/4" x 7-1/4" x 12")
Net weight	4.4 kg (9.7 lbs.)

Bluetooth

18V 14.4V 12Vmax 10.8V



AC Adaptor, AA Battery

DMR108 Job Site Radio

7.2V-18V CXT LXT Li-Ion Cordless Bluetooth Job Site Radio

Li-ion Ah 6.0 5.0 3.0 1.5



Frequency Band	FM / AM: 87.5 - 108 MHz / 522 - 1,710 kHz
Speaker Size	Woofer: Ø89 mm x 2
Max Output	18V: 3.5 W x 2 / 14.4V: 2.2 W x 2 / 12Vmax: 1.2 W x 2 / 7.2V: 0.5 W x 2
Bluetooth	Version: 4.0 Profile: A2DP / SCMS-T Supported Codec: SBC Max Transmission Range: 10 m (33 ft)
Dimensions (L x W x H)	w/ Handle in Upright Position: 262 x 163 x 431 mm (10-3/8" x 6-3/8" x 17")
Net weight	4.4 kg (9.7 lbs.)

Bluetooth

18V 14.4V 12Vmax 10.8V 7.2V



AC Adaptor, AA Battery

MR010G Cordless Radio with Lantern

40Vmax XGT Cordless Bluetooth Radio with Lantern

Li-ion Ah 8.0 5.0 4.0 2.5 2.0



Frequency Band	FM: 87.5-108 MHz
Speaker Size	Ø57 mm
Illuminance (High/Low)*	Flashlight: 1,000/500, Lantern: Daylight white 145/72, Neutral white 140/70, Warm white 130/65
Luminous flux (High/Low)	Flashlight: 200/100, Lantern: Daylight white 310/155, Neutral white 300/150, Warm white 260/130
Bluetooth	Version: 5.0, Profile: A2DP, SCMS-T, AVRCP, Supported Codec: SBC, Max Transmission Range (Optimum): 10 m (33 ft)
Dimensions (L x W x H)	w/o Battery: 126 x 127 x 240 mm (5 x 5 x 9-1/2")
Net weight	1.6 - 2.2 kg (3.5 - 4.9 lbs.)

Bluetooth

40Vmax XGT XPT

Strap Hook, Battery and Charger are sold separately

DMR057 Cordless Radio with Lantern

18V/14.4V LXT Cordless Radio with Lantern

Li-ion Ah 6.0 5.0 3.0 1.5



Frequency Band	FM: 87.5-108 MHz
Speaker Size	Ø57 mm
Illuminance (High/Low)*	Flashlight: 1,000/500, Lantern: Daylight white 145/72, Neutral white 140/70, Warm white 130/65
Luminous flux (High/Low)	Flashlight: 200/100, Lantern: Daylight white 310/155, Neutral white 300/150, Warm white 260/130
Bluetooth	Version: 5.0, Profile: A2DP, SCMS-T, AVRCP, Supported Codec: SBC, Max Transmission Range (Optimum): 10 m (33 ft)
Dimensions (L x W x H)	w/o Battery: 126 x 127 x 240 mm (5 x 5 x 9-1/2")
Net weight	1.3 - 1.6 kg (2.9 - 3.5 lbs.)

Bluetooth

18V 14.4V LXT XPT

Strap Hook, Battery and Charger are sold separately

Cordless Radio with Lantern that can be used at work, play, or anytime

Lantern with 3 light tone settings*



Warm white	Neutral white	Daylight white
You will feel relaxed. (about 2,500K)	(about 3,500K)	You can easily read what is written / printed. (about 5,000K)



Flashlight*

- Daylight white single LED
- Brightness settings (2 stages)

USB output port*

- With USB output switch
- With Auto-off function
- Type A, 1 port, DC5V / 2.4A

*MR010G / DMR057 only

LIGHTS

PRODUCTS



ML009G Cordless Worklight

XGT LXT Li-Ion Cordless 96 LED Worklight, 10,000 Lumens

Li-ion Ah 8.0 | 5.0 | 4.0 | 2.5 | 2.0



Run Time (hrs)	w/ BL4040 x2, Low/Mid/High: 14/6.5/2.4 at 1m from the light source: 4,300/1,900/1,000 lx at 3m from the light source: 500/230/110 lx
Luminous Flux	High/Mid/Low: 10,000/4,000/2,000 lm
Dimensions (L x W x H)	w/ Handle in Retracted Position: 248 x 386 x 305 mm, w/ Handle in Upright Position: 248 x 386 x 430 mm
Net weight	6.4 - 9.9 kg (14.1 - 21.8 lbs.)

40Vmax 18V 14.4V XGT LXT

Anti-glare film, Battery and Charger are sold separately

ML005GX Cordless Worklight

40Vmax XGT Li-Ion Cordless LED Worklight, 3,600 Lumens

Li-ion Ah 8.0 | 5.0 | 4.0 | 2.5 | 2.0



Illuminance (High / Mid / Low)	at 1m from the light source: 2,100 / 1,000 / 500 lx
Luminous Flux	High / Mid / Low: 3,600 / 1,800 / 900 lm
Dimensions (L x W x H)	w/ Handle in Retracted Position: 248 x 309 x 296 mm (9-3/4 x 12-1/8 x 11-5/8")
Net weight	4.6 - 6.5 kg (10.1 - 14.3 lbs.)

40Vmax 18V 14.4V XGT LXT

Battery and Charger are sold separately

ML003G Cordless LED Worklight

High-intensity LED lights for wider range

Li-ion Ah 5.0 | 4.0 | 2.5 | 2.0



Run Time (hrs)	Up to: 22 (Low mode, with BL4040) at 1m from the light source: 500/200 lx at 0.5m from the light source: 1,900/800 lx
Luminous Flux	High/Low: 1,100/450 lm
Dimensions (L x W x H)	w/ Handle in Retracted Position: 249x298x280mm (9-3/4"x11-3/4"x11") w/ Handle in Upright Position: 249x298x386 mm (9-3/4"x11-3/4"x15-1/4")
Net weight	3.7 - 4.7 kg (8.2 - 10.4 lbs.)

40Vmax 18V XGT LXT

Battery and Charger are sold separately

DML811 18V, 14.4V / AC Cordless Worklight

30 super luminous daylight white LEDs

Li-ion Ah 6.0 | 5.0 | 3.0 | 1.5



Run Time (hrs)	Up to: 13
Illuminance (High / Mid / Low)	at 1m from the light source: 1,800 / 800 / 350 lx at 3m from the light source: 200 / 100 / 40 lx at 5m from the light source: 85 / 40 / 17 lx
Luminous Flux	High / Mid / Low: 3,000 / 1,500 / 750 lm
Dimensions (L x W x H)	w/ Handle in Retracted Position: 249 x 302 x 271 mm (9-3/4 x 11-7/8 x 10-5/8")
Net weight	4.1 - 4.8 kg (9.0 - 10.5 lbs.)

Power Supply Cord: 2.5 m (8.2 ft)

18V 14.4V LXT

AC Power Cord, Battery and Charger are sold separately

DML809 18V, 14.4V / AC Cordless Worklight

Cordless 96 LED Worklight, 10,000 Lumens

Li-ion Ah 6.0 | 5.0 | 3.0 | 1.5



Run Time (hrs)	Up to: 8.5
Illuminance (High / Mid / Low)	at 1m from the light source: 3,800 / 1,500 / 800 lx at 3m from the light source: 380 / 150 / 80 lx at 5m from the light source: 150 / 60 / 30 lx
Luminous Flux	High / Mid / Low: 10,000 / 4,000 / 2,000 lm
Dimensions (L x W x H)	w/ Handle in Retracted Position: 249x370x278 mm (9-3/4"x14-1/2"x11") w/ Handle in Upright Position: 249x370x370 mm (9-3/4"x14-1/2"x14-1/2")
Net weight	5.7 - 7.0 kg (12.6 - 15.4 lbs.)

Power Supply Cord: 2.5 m (8.2 ft)

18V 14.4V LXT

AC Power Cord, Battery and Charger are sold separately

DML805 Corded and Cordless LED Worklight

L.E.D. Lights Deliver Bright and Even Lighting For Large Workspaces

Li-ion Ah 6.0 | 5.0 | 3.0 | 1.5



Run Time (hrs)	Up to: 17
Illuminance	at 0.5m from the light source Hi: 1,150 lx, Lo: 750 lx at 1m from the light source Hi: 300 lx, Lo: 200 lx at 1m from the light source Hi: 750 lm, Lo: 450 lm
Luminous Flux	
Net weight	2.3 - 2.7 kg (5.1 - 5.9 lbs.)

Power supply cord: 2.5m (8.2ft)

18V 14.4V LXT

Battery and Charger are sold separately

Lighting coverage*

*measured in accordance with ANSI

DML805

Front **2.3m**
(side: 2.6m)

ML003G

Front **2.8m**
(side: 3.0m)

DML812

Front **2.8m**
(side: 3.0m)

ML007G

DML813 / DML814

Front **4.5m**
(side: 5.3m)
Front **4.7m**
(side: 5.6m)

DML811

Front **6.0m**
(side: 6.0m)

Long-distance irradiation

640m

Spot mode

Luminous flux

18V

DML805

750 lm

18V 40V max

ML003G

1,100 lm

18V

DML812

40V max

ML007G

18V

DML813 / DML814

18V

DML811

1,250 lm

Spot+Flood mode

3,000 lm

DML813 / DML814 Cordless Worklight

Cordless 12 LED Worklight, 3,000 Lumens

Li-ion Ah	6.0 5.0 3.0 1.5
Run Time (hrs)	w/ BL1850(B) Low / Mid / High: 10 / 5.5 / 3
Illuminance (High / Mid / Low)	at 1m from the light source: 1,250 / 750 / 400 lx at 3m from the light source: 130 / 80 / 40 lx at 5m from the light source: 50 / 30 / 15 lx
Luminous Flux	High / Mid / Low: 3,000 / 1,700 / 900 lm
Dimensions (L x W x H)	Folding Position: 260x216x1,000 mm (10-1/4"x8-1/2"x39-3/8") Operating Position (Max Height): 573x658x1,250-2,240 mm (22-1/2"x26"x49-1/4"-88")
Net weight	DML813: 7.2-7.9 kgv DML814: 7.4-8.1 kg

DML813

DML814

18V 14.4V

Shoulder Belt. Battery and Charger are sold separately

ML010G 40Vmax, 18V, 14.4V / AC Cordless Area Worklight

40Vmax XGT / 18V, 14.4V LXT Li-Ion Cordless Area Worklight, 5,500 Lumens

Li-ion Ah	5.0 4.0 2.5 2.0
Illuminance (High / Med. / Low)	at 1 m from the light source: 550 / 300 / 150 lx at 3 m from the light source: 70 / 40 / 20 lx at 5 m from the light source: 25 / 15 / 7 lx
Luminous flux	High / Med. / Low: 5,500 / 3,000 / 1,500 lm
Continuous run time on full battery charge (High / Med. / Low)	w/ BL1860B x2: 4.5 / 8.5 / 16 hours w/ BL4040 x2: 6.5 / 11 / 21 hours
Dimensions (L x W x H)	490 x 490 x 814 mm
Net weight	14.4 - 19.2 kg (31.7 - 42.3 lbs.)

1

40Vmax 18V 14.4V

AC power cord. Battery and Charger are sold separately

Items of standard equipment and specifications may vary by country or area. Net weight and dimensions may differ by the type of battery.

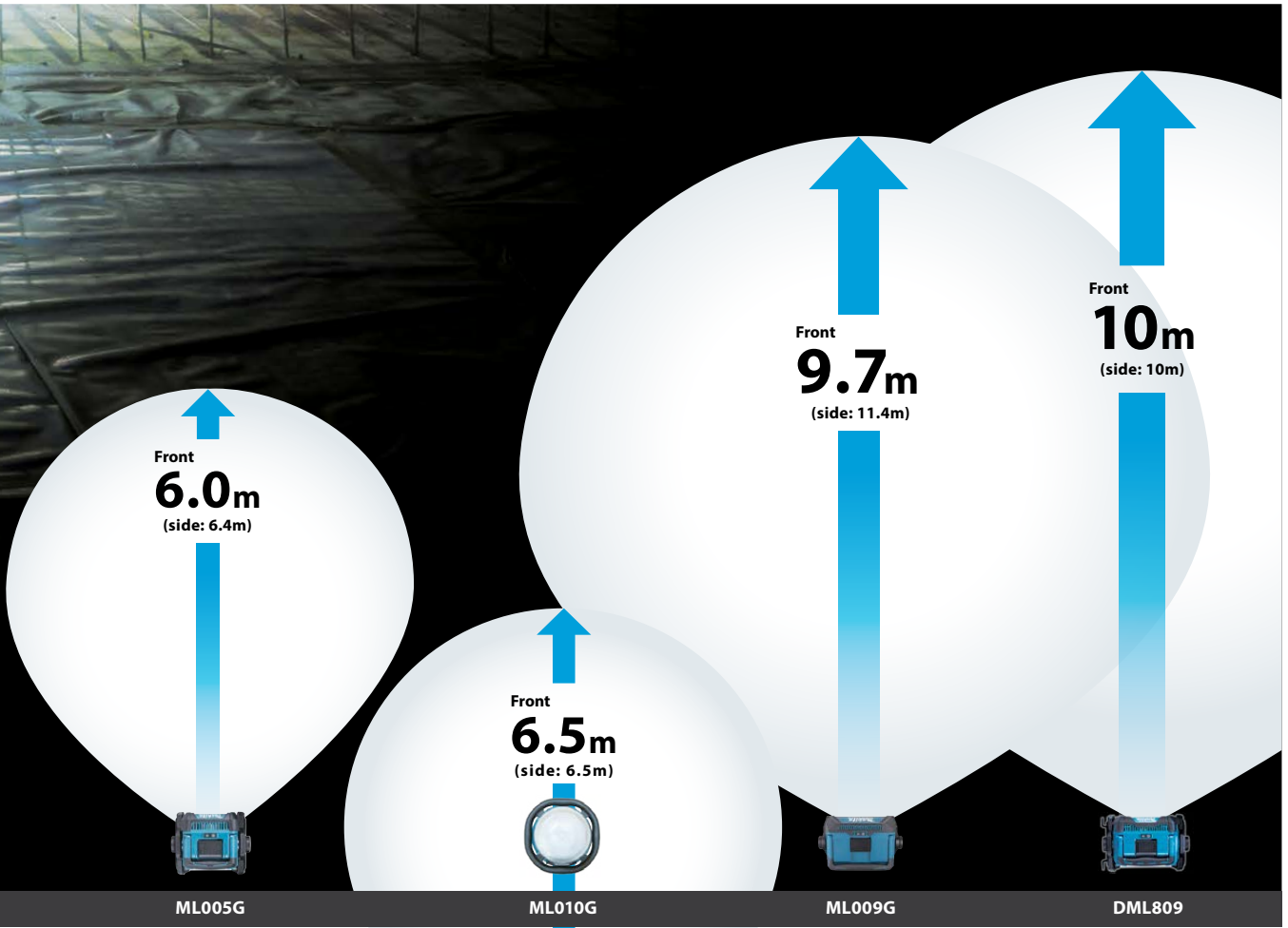

Up to 4 batteries can be installed in parallel.
two LXT batteries + two XGT batteries



Continuous run time (approx) Low mode
59 hours
Battery: BL4080F x2 & BL1860B x2
all LEDs light up

3 brightness settings with memory function of the setting last time you power off



Improved Self-righting performance



photo: ML010G



DML810 18V, 14.4V / AC Cordless Area Worklight

18V/14.4V LXT Li-Ion Cordless 202 LED Area Worklight, 5,500 Lumens

Li-ion Ah 6.0 5.0 3.0 1.5



Run Time (hrs)	Up to: 18
Illuminance (High / Mid / Low)	at 1m from the light source: 550 / 300 / 150 lx at 3m from the light source: 70 / 40 / 20 lx at 5m from the light source: 25 / 15 / 7 lx
Luminous Flux	High / Mid / Low: 5,500 / 3,000 / 1,500 lm
Dimensions (L x W x H)	420 x 420 x 787 mm (16-1/2 x 16-1/2 x 31")
Net weight	13.9 - 15.3 kg (30.6 - 33.7 lbs.)

Power Supply Cord: 2.5 m (8.2 ft)

18V 14.4V LXT XPT 1

AC Power Cord. Battery and Charger are sold separately

ML007G Cordless Flashlight

40Vmax XGT Li-Ion Flashlight Provides 500 Lumens

Li-ion Ah 8.0 5.0 4.0 2.5 2.0



Run Time (hrs)	Up to: 14 (Spot, with BL4050F)
Illuminance	Spot / Flood / Spot-Flood: 82,000 / 520 / 60,000 lx
Luminous Flux	Spot / Flood / Spot-Flood: 600 / 1,000 / 1,250 lm
Dimensions (L x W x H)	w/ BL4025: 330 x 120 x 118 mm (13 x 4-3/4 x 4-5/8")
Net weight	1.6 - 2.9 kg (3.5 - 6.4 lbs.)

40Vmax XGT XPT

Battery and Charger are sold separately

DML812 Cordless Flashlight

LED Flashlight, 1,250 Lumens

Li-ion Ah 6.0 5.0 3.0 1.5



Run Time (hrs)	Up to: 10 (Spot, with BL1860B)
Illuminance	at 1m from the light source Spot Mode / Flood Mode / Spot-Flood Mode: 71,000 / 520 / 51,000 lx
Luminous Flux	Spot Mode / Flood Mode / Spot-Flood Mode: 600 / 1,000 / 1,250 lm
Dimensions (L x W x H)	w/ BL1830B / BL1850B / BL1860B: 313 x 119 x 115 mm (12-3/8" x 4-1/16" x 4-1/2")
Net weight	1.2 - 1.6 kg (2.6 - 3.4 lbs.)

Illuminance: at 1m from the light source

18V 14.4V LXT XPT 8

Strap Hook. Battery and Charger are sold separately

ML001G LED Flashlight

40Vmax XGT Li-Ion LED Flashlight, 160 Lumens

Li-ion Ah 8.0 5.0 4.0 2.5 2.0



Run Time (hrs)	Up to: 55
Luminous Flux	160 lm
Illuminance	at 1m from the light source: 3,000 lx
Dimensions (L x W x H)	w/ BL4025: 281 x 88 x 121 mm (11-1/8 x 3-1/2 x 4-3/4") w/ BL4040: 287 x 88 x 136 mm (11-1/4 x 3-1/2 x 5-3/8")
Net weight	1.0 - 1.3 kg (2.2 - 2.9 lbs.)

40Vmax XGT 12

Strap Hook. Battery and Charger are sold separately

DML815 18V, 14.4V Cordless LED Flashlight

18V / 14.4V LXT Li-Ion LED Flashlight, 160 Lumens

Li-ion Ah 6.0 5.0 3.0 1.5



Run Time (hrs)	Up to: 54
Luminous Flux	160 lm
Illuminance	at 1m from the light source: 3,000 lx
Dimensions (L x W x H)	w/ BL1830B / BL1850B / BL1860B: 272 x 79 x 116 mm (10-3/4" x 3-1/8" x 4-9/16")
Net weight	0.26 - 0.93 kg (0.57 - 2.05 lbs.)

18V 14.4V 5

Strap Hook. Battery and Charger are sold separately

ML106 Cordless Flashlight

Multifaceted Reflector Illuminates Evenly for Increased Visibility

Li-ion Ah 5.0 4.0 2.0 1.5



Run Time (hrs)	Up to: 12
Luminous Flux	190 lm
Luminous	at 1m from the light source: 170 - 4,500 lx
Dimensions (L x W x H)	w/ BL1016 / BL1021B: 271 x 66 x 93 mm (10-5/8 x 2-5/8 x 3-5/8") w/ BL1041B: 290 x 66 x 93 mm (11-3/8 x 2-5/8 x 3-5/8")
Net weight	0.61 - 0.78 kg (1.3 - 1.7 lbs.)

12Vmax XPT 8

Strap Hook. Battery and Charger are sold separately

ML002G Cordless LED Worklight

40Vmax XGT Li-Ion 21 LED Worklight, 710 Lumens

Li-ion Ah 5.0 4.0 2.5 2.0



Run Time (hrs)	Up to: 51
Main light (on bar side)	Luminous flux (Full brightness): 710 lm Illuminance (Full brightness): 340 lx Luminous flux (Half brightness): 340 lm Illuminance (Half brightness): 310 lx
Sub light (on top side)	Luminous flux: 130 lm Illuminance: 1,900 lx
Dimensions (L x W x H)	w/ BL4025: 376 x 86 x 126 mm w/ BL4040: 382 x 86 x 141 mm
Net weight	1.2 - 1.5 kg (2.7 - 3.3 lbs.)

Length (with the hook stood). Illuminance: at 50 cm from the light source

40Vmax XGT XPT 6

Battery and Charger are sold separately



DML807 Cordless LED Flashlight

18V / 14.4V LXT Li-Ion 21 LED Flashlight

Li-ion Ah 6.0 5.0 3.0 1.5



Run Time (hrs)	Up to: 43
Main light (on bar side)	Luminous flux (Full brightness): 710 lm Illuminance (Full brightness): 340 lx
Sub Light (on top side)	Luminous flux: 130 lm Illuminance: 1,900 lx
Dimensions (L x W x H)	414 x 79 x 155 mm (16-1/4 x 3-1/8 x 6-1/8")
Net weight	0.72 - 1.1 kg (1.6 - 2.4 lbs.)

Length (with the hook stood), Illuminance: at 50 cm from the light source

18V 14.4V LXT XPT USB

Battery and Charger are sold separately

Rotatable and foldable light head

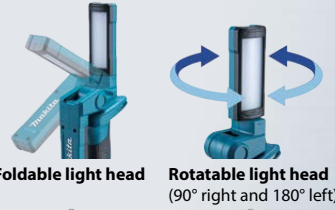

Foldable light head **Rotatable light head** (90° right and 180° left)



Can be used as a compact stationary lamp with the light head swivelled and folded fully.

Max luminous flux
500 lm



ML006G Cordless Flashlight

40Vmax XGT Li-Ion Flashlight Provides 500 Lumens

Li-ion Ah 5.0 4.0 2.5 2.0



Run Time (hrs)	Up to: 82 (Low mode, with BL4040)
Illuminance (at 0.5m from the light source)	High / Medium / Low: 800 / 400 / 180 lx
Luminous Flux	High / Medium / Low: 500 / 250 / 100 lm w/ BL4040:
Dimensions (L x W x H)	275 - 408 x 85 x 148 mm (10-7/8 - 16 x 3-3/8 x 5-7/8")
Net weight	1.1 - 1.7 kg (2.4 - 3.8 lbs.)

40Vmax XGT XPT

Shoulder hook set, Lamp shade, Battery and Charger are sold separately

DML816 Cordless Flashlight

18V LXT Li-Ion Flashlight Provides 500 Lumens

Li-ion 6.0 5.0 3.0 1.5



Run Time (hrs)	Up to: 75 (Low mode, with BL1860B)
Illuminance (at 0.5m from the light source)	High / Medium / Low: 800 / 400 / 180 lx
Luminous Flux	High / Medium / Low: 500 / 250 / 100 lm w/ BL1830B / BL1850B / BL1860B:
Dimensions (L x W x H)	267 - 400 x 79 x 127 mm (10-1/2 - 15-3/4 x 3-1/8 x 5")
Net weight	0.70 - 1.1 kg (1.5 - 2.4 lbs.)

18V 14.4V LXT XPT

Shoulder hook set, Lamp shade, Battery and Charger are sold separately



ML011G Cordless Worklight

40Vmax XGT Li-Ion Cordless Worklight, 300 Lumens

Li-ion Ah 5.0 4.0 2.5 2.0



Illuminance (at 0.5 m from the light source)	Sidelighting + Uplighting / Sidelighting only / Uplighting only: 240 / 190 / 190 lx
Luminous flux	Sidelighting + Uplighting / Sidelighting only / Uplighting only: 300 / 150 / 150 lm w/ BL4040, at 300 lm: 37, w/ BL1860B, at 150 lm: 64
Run time (hrs)	w/o Battery: 107 x 77 x 50 mm
Dimensions (L x W x H)	
Net weight	0.19 kg (0.42 lbs.)

40Vmax XGT USB

Warm color cover, Battery and Charger are sold separately

DML817 Cordless Worklight

18V/14.4V LXT Li-Ion Cordless Worklight, 300 Lumens

Li-ion Ah 6.0 5.0 3.0 1.5



Illuminance (at 0.5 m from the light source)	Sidelighting + Uplighting / Sidelighting only / Uplighting only: 240 / 190 / 190 lx
Luminous flux	Sidelighting + Uplighting / Sidelighting only / Uplighting only: 300 / 150 / 150 lm w/ BL1860B, at 300 lm: 28, w/ BL1860B, at 150 lm: 49
Run time (hrs)	w/ BL1860B, at 300 lm: 28, w/ BL1860B, at 150 lm: 49
Dimensions (L x W x H)	w/o Battery: 107 x 77 x 50 mm
Net weight	0.21 kg (0.46 lbs.)

18V 14.4V LXT USB

Warm color cover, Battery and Charger are sold separately

ML107 Cordless Worklight

12Vmax CXT Li-Ion Cordless Worklight, 200 Lumens

Li-ion Ah 5.0 4.0 2.0 1.5



Illuminance (at 0.5 m from the light source)	Sidelighting + Uplighting / Sidelighting only / Uplighting only: 175 / 130 / 130 lx
Luminous flux	Sidelighting + Uplighting / Sidelighting only / Uplighting only: 200 / 100 / 100 lm w/ BL1041B, at 300 lm: 17, w/ BL1041B, at 150 lm: 29
Run time (hrs)	w/o Battery: 92 x 54 x 47 mm
Dimensions (L x W x H)	
Net weight	0.29 kg (0.13 lbs.)

12Vmax CXT USB

Warm color cover, Battery and Charger are sold separately

DML807 Cordless LED Flashlight

18V / 14.4V LXT Li-Ion 21 LED Flashlight

Li-ion Ah 6.0 5.0 3.0 1.5



Run Time (hrs)	Up to: 43
Main light (on bar side)	Luminous flux (Full brightness): 710 lm Illuminance (Full brightness): 340 lx
Sub Light (on top side)	Luminous flux: 130 lm Illuminance: 1,900 lx
Dimensions (L x W x H)	414 x 79 x 155 mm (16-1/4 x 3-1/8 x 6-1/8")
Net weight	0.72 - 1.1 kg (1.6 - 2.4 lbs.)

Length (with the hook stood), Illuminance: at 50 cm from the light source

18V 14.4V LXT XPT USB

Battery and Charger are sold separately

Rotatable and foldable light head

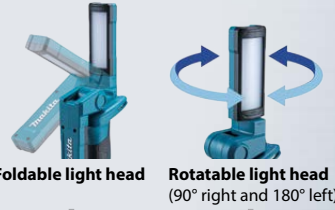

Foldable light head Rotatable light head (90° right and 180° left)



Can be used as a compact stationary lamp with the light head swivelled and folded fully.

Max luminous flux
500 lm



ML006G Cordless Flashlight

40Vmax XGT Li-Ion Flashlight Provides 500 Lumens

Li-ion Ah 5.0 4.0 2.5 2.0



Run Time (hrs)	Up to: 82 (Low mode, with BL4040)
Illuminance (at 0.5m from the light source)	High / Medium / Low: 800 / 400 / 180 lx
Luminous Flux	High / Medium / Low: 500 / 250 / 100 lm w/ BL4040:
Dimensions (L x W x H)	275 - 408 x 85 x 148 mm (10-7/8 - 16 x 3-3/8 x 5-7/8")
Net weight	1.1 - 1.7 kg (2.4 - 3.8 lbs.)

40Vmax XGT XPT

Shoulder hook set, Lamp shade, Battery and Charger are sold separately

DML816 Cordless Flashlight

18V LXT Li-Ion Flashlight Provides 500 Lumens

Li-ion 6.0 5.0 3.0 1.5



Run Time (hrs)	Up to: 75 (Low mode, with BL1860B)
Illuminance (at 0.5m from the light source)	High / Medium / Low: 800 / 400 / 180 lx
Luminous Flux	High / Medium / Low: 500 / 250 / 100 lm w/ BL1830B / BL1850B / BL1860B:
Dimensions (L x W x H)	267 - 400 x 79 x 127 mm (10-1/2 - 15-3/4 x 3-1/8 x 5")
Net weight	0.70 - 1.1 kg (1.5 - 2.4 lbs.)

18V 14.4V LXT XPT

Shoulder hook set, Lamp shade, Battery and Charger are sold separately



ML011G Cordless Worklight

40Vmax XGT Li-Ion Cordless Worklight, 300 Lumens

Li-ion Ah 5.0 4.0 2.5 2.0



Illuminance (at 0.5 m from the light source)	Sidelighting + Uplighting / Sidelighting only / Uplighting only: 240 / 190 / 190 lx
Luminous flux	Sidelighting + Uplighting / Sidelighting only / Uplighting only: 300 / 150 / 150 lm w/ BL4040, at 300 lm: 37, w/ BL4040, at 150 lm: 64
Run time (hrs)	w/o Battery: 107 x 77 x 50 mm
Dimensions (L x W x H)	
Net weight	0.19 kg (0.42 lbs.)

40Vmax XGT USB

Warm color cover, Battery and Charger are sold separately

DML817 Cordless Worklight

18V/14.4V LXT Li-Ion Cordless Worklight, 300 Lumens

Li-ion Ah 6.0 5.0 3.0 1.5



Illuminance (at 0.5 m from the light source)	Sidelighting + Uplighting / Sidelighting only / Uplighting only: 240 / 190 / 190 lx
Luminous flux	Sidelighting + Uplighting / Sidelighting only / Uplighting only: 300 / 150 / 150 lm w/ BL1860B, at 300 lm: 28, w/ BL1860B, at 150 lm: 49
Run time (hrs)	w/ BL1860B, at 300 lm: 28, w/ BL1860B, at 150 lm: 49
Dimensions (L x W x H)	107 x 77 x 50 mm
Net weight	0.21 kg (0.46 lbs.)

18V 14.4V LXT USB

Warm color cover, Battery and Charger are sold separately

ML107 Cordless Worklight

12Vmax CXT Li-Ion Cordless Worklight, 200 Lumens

Li-ion Ah 5.0 4.0 2.0 1.5



Illuminance (at 0.5 m from the light source)	Sidelighting + Uplighting / Sidelighting only / Uplighting only: 175 / 130 / 130 lx
Luminous flux	Sidelighting + Uplighting / Sidelighting only / Uplighting only: 200 / 100 / 100 lm w/ BL1041B, at 300 lm: 17, w/ BL1041B, at 150 lm: 29
Run time (hrs)	w/o Battery: 92 x 54 x 47 mm
Dimensions (L x W x H)	
Net weight	0.29 kg (0.13 lbs.)

12Vmax CXT USB

Warm color cover, Battery and Charger are sold separately

As a charger for smartphones, tablets and more

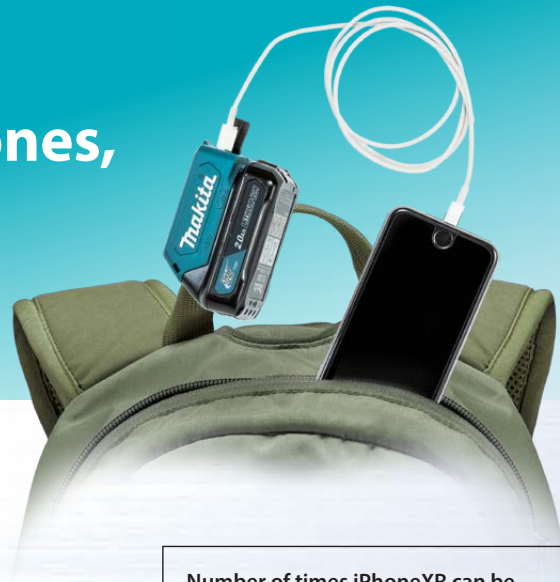

Adapter for USB ADP001G

40V max

Strap hole

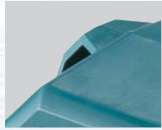

ON-OFF switch



Number of times iPhoneXR can be recharged on a single full battery charge

- BL4020 (2.0Ah): 2.8
- BL4025 (2.5Ah): 3.5
- BL4040 (4.0Ah): 5.6
- BL4050F (5.0Ah): 7.0

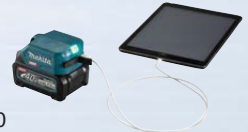

USB output port

- enables to charge two mobile devices at the same time
- Type A USB sockets for DC5V/ 2.1A (one port), 4.2A (two ports) USB output



Adapter for USB ADP08

12V max



ON-OFF switch



Strap hole



USB output port

Type A USB port for DC5V/ 2.1A
USB output



Adapter for USB Series

ADP05 18V



ADP06 12V max



2 USB output ports with Caps provide 4.2A output for charging smart phones, tablets, etc.



ADP05 only

Belt clip



Strap hole



ADP05 only

OPE TOOLS

PRODUCTS



UX01GZ Cordless Multi Function Power Head

High power BL motor enables to work under heavy load

Li-ion Ah 8.0 | 5.0 | 4.0 | 2.5 | 2.0



No Load Speed (RPM) High: 0-9,700
Medium: 0-8,200
Low: 0-5,700
Dimensions (L x W x H) 1,027 x 320 x 209 mm (40-1/2 x 12-5/8 x 8-1/4")
Net weight 4.1-4.7 kg (9.3-10.6 lbs.)

DUX60Z Cordless Multi Function Power Head

Multi Function System

Li-ion Ah 6.0 | 5.0 | 3.0 | 1.5



No Load Speed (RPM) High: 0-9,700
Medium: 0-8,200
Low: 0-5,700
Dimensions (L x W x H) 1,011 x 320 x 216 mm (39-3/4 x 12-5/8 x 8-1/2")
Net weight 4.1-8.7 kg (8.9-19.2 lbs.)

40Vmax



Harness, Safety Goggles, Hex Wrench, Accessory Bag, Z: Battery and Charger are sold separately

18V x2

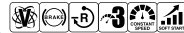

Harness, Safety Goggles, Hex Wrench, Accessory Bag, Z: Battery and Charger are sold separately

Optional attachments

UX01G / DUX60 / DUX18

Consisting of power head and versatile optional attachments are ideal for a wide range of applications



Rotary Scissors
EM407MP
191M60-2



Shaft extension
LE400MP
191E23-0
Length: 1,080mm (42-1/2")
For Pole saw, Pole hedge trimmer and Coffee harvester



Ground Trimmer
EN424MP
1913D3-2



Pump
PF400MP
A-75384



This movie was filmed in Japan. Models and specs may vary by country.

Grass trimmer
EM408MP
191N35-7
EM409MP
191N48-8



Coffee harvester
EJ400MP
195726-8
197163-2



Pole saw
EY401MP
199925-4



Cultivator
KR400MP / KR401MP
195712-9 / 195716-1



Edger
EE400MP
196750-4



Brushcutter
EM400MP / EM402MP
195658-9 / 195952-9



Blower
UB401MP
191P78-1



Power sweep
SW400MP
199344-4

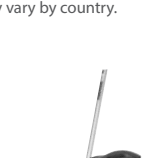

Power brush
BR400MP
199323-2

Ground trimmer
EN420MP
198061-3



Hedge trimmer
EN410MP / EN401MP
197742-6 / 196341-1



String trimmer
ER400MP
195530-5



DUX18Z Cordless Multi Function Power Head

Multi Function System

Li-ion Ah 6.0 | 5.0 | 3.0 | 1.5



No Load Speed (RPM)	High: 0-9,700 Low: 0-6,800
Dimensions (L x W x H)	w/BL1830B / BL1850B / BL1860B: 977 x 318 x 175 mm (38-3/4 x 12-1/2 x 6-7/8")
Net weight	2.8-10.3 kg (6.2-22.7 lbs.)

18V



Harness, Safety Goggles, Hex Wrench, Accessory Bag, Z: Battery and Charger are sold separately

UC003GZ01 300mm (12") Cordless Chain Saw

40Vmax XGT BL Brushless Cordless 30 cm (12") Chain Saw

Li-ion Ah 5.0 | 4.0 | 2.5 | 2.0



Guide Bar Length	300 mm (12")
Chain Pitch	3/8"
Chain Gauge	1.1 mm (0.043")
Chain Speed	0-24.8 m/s (0-1,490 m/min) (0-4,880 FPM)
Chain Oil Tank Volume	200 mL (6.8 US oz)
Dimensions (L x W x H)	w/o Guide Bar :266 x 194 x 227 mm (10-1/2 x 7-5/8 x 8-15/16")
Net weight	3.9-4.5 kg (8.6-9.9 lbs.)

40Vmax



Saw Chain, Guide Bar, Guide Bar Cover, Oil supply (country-specific), Round File (country-specific), Box Wrench, Battery, Charger, Z: Battery and Charger are sold separately

UC022GZ 350mm (14") Cordless Chain Saw

New

40Vmax XGT BL Brushless Cordless 35 cm (14") Chain Saw

Li-ion Ah 8.0 | 5.0 | 4.0 | 2.5 | 2.0



Guide Bar Length	350 mm (14")
Recommended guide bar length	300-400 mm (12-16")
Chain type	80T XL
Chain Pitch	0.325"
Chain Gauge	1.1 mm (0.043")
Chain Speed	0-25.5 m/s
Chain Oil Tank Volume	200 mL (6.8 US oz)
Dimensions (L x W x H)	w/o Guide bar, w/BL4050F: 430 x 225 x 271 mm (17 x 8-7/8 x 10-5/8")
Net weight	5.1-5.5 kg (11.2-12.1 lbs.)

40Vmax



Z: Battery and Charger are sold separately

UC012GT101(RT) / GZ 400mm (16") Cordless Chain Saw

40Vmax XGT BL Brushless Cordless Chain Saw

Li-ion Ah 8.0 | 5.0 | 4.0 | 2.5 | 2.0



Guide Bar Length	400 mm (16")
Chain Pitch	3/8"
Chain Gauge	1.1 mm (0.043")
Chain Speed	0-24.7 m/s (0-1,482 m/min) (0-4,862 FPM)
Chain Oil Tank Volume	230 mL (7.8 US oz)
Dimensions (L x W x H)	w/o Guide Bar: 446 x 233 x 274 mm (17-1/2 x 9-1/8 x 10-3/4")
Net weight	6.0-6.5 kg (13.2-14.4 lbs.)

40Vmax



Saw Chain, Guide Bar, Guide Bar Cover, Oil supply (country-specific), Round File (country-specific), Box Wrench, Battery, Charger, Z: Battery and Charger are sold separately

UC015GT101(RT) / GZ 350mm (14") Cordless Chain Saw

40Vmax XGT BL Brushless Cordless Chain Saw

Li-ion Ah 8.0 | 5.0 | 4.0 | 2.5 | 2.0



Guide Bar Length	350 mm (14")
Chain Pitch	3/8"
Chain Gauge	1.1 mm (0.043")
Chain Speed	0-24.7 m/s (0-1,482 m/min) (0-4,862 FPM)
Chain Oil Tank Volume	230 mL (7.8 US oz)
Dimensions (L x W x H)	w/o Guide Bar: :446 x 233 x 274 mm (17-1/2 x 9-1/8 x 10-3/4")
Net weight	6.0-6.5 kg (13.2-14.4 lbs.)

40Vmax



Saw Chain, Guide Bar, Guide Bar Cover, Oil supply (country-specific), Round File (country-specific), Box Wrench, Battery, Charger, Z: Battery and Charger are sold separately

UC014GT101(RT) / GZ 300mm (12") Cordless Chain Saw

40Vmax XGT BL Brushless Cordless Chain Saw

Li-ion Ah 8.0 | 5.0 | 4.0 | 2.5 | 2.0



Guide Bar Length	300 mm (12")
Chain Pitch	3/8"
Chain Gauge	1.1 mm (0.043")
Chain Speed	0-24.7 m/s (0-1,482 m/min) (0-4,862 FPM)
Chain Oil Tank Volume	230 mL (7.8 US oz)
Dimensions (L x W x H)	w/o Guide Bar: :446 x 233 x 274 mm (17-1/2 x 9-1/8 x 10-3/4")
Net weight	6.0-6.5 kg (13.2-14.4 lbs.)

40Vmax



Saw Chain, Guide Bar, Guide Bar Cover, Oil supply (country-specific), Round File (country-specific), Box Wrench, Battery, Charger, Z: Battery and Charger are sold separately

DUC353ZB 350mm (14") Cordless Chain Saw

High efficiency equivalent to 30mL class engine chain saws

Li-ion Ah 6.0 | 5.0 | 3.0 | 1.5



Guide Bar Length	350 mm (14")
Chain Pitch /	9.5 mm (3/8") /
Chain Gauge	1.1 / 1.3 mm (.043" / .050")
Chain Speed	0-20 m/s (0-1,200 m/min)
Chain Oil Tank Volume	200 mL
Sound Power Level	98.7 dB(A)
Dimensions (L x W x H)	762 x 215 x 235 mm (30" x 8-1/2" x 9-1/4")
Net weight	4.7 kg - 5.4 kg (10.4 lbs - 11.8 lbs)

18V x2



Saw Chain, Guide Bar, Guide Bar Cover, Chain oil 100mL, Z: Battery and Charger are sold separately

DUC355Z 350mm (14") Cordless Chain Saw

High efficiency equivalent to 30mL class engine chain saws

Li-ion Ah 6.0 | 5.0 | 3.0 | 1.5



Guide Bar Length	350 mm (14")
Chain Pitch /	9.5 mm (3/8") /
Chain Gauge	1.1 / 1.3 mm (.043" / .050")
Chain Speed	0-20 m/s (0-1,200 m/min)
Chain Oil Tank Volume	200 mL
Sound Power Level	98.7 dB(A)
Dimensions (L x W x H)	762 x 215 x 235 mm (30" x 8-5/16" x 9-1/4")
Net weight	4.7 kg - 5.4 kg (10.4 lbs - 11.8 lbs)

18V x2



Saw Chain, Guide Bar, Guide Bar Cover, Chain oil 100mL, Wrench, Z: Battery and Charger are sold separately

DUC306ZB 300mm (12") Cordless Chain Saw

High efficiency equivalent to 30mL class engine chain saws

Li-ion Ah 6.0 5.0 3.0 1.5



Guide Bar Length	300 mm (12")
Chain Pitch / Chain Gauge	9.5 mm (3/8") / 1.1 or 1.3 mm (0.043" or 0.050")
Chain Speed	0-20 m/s (0-1,200 m/min) (0-3,940 FPM)
Chain Oil Tank Volume	200 mL (6.8 US oz)
Sound Power Level	103 dB(A)
Dimensions (L x W x H)	270-651 x 205 x 232 mm (10-5/8" x 8-1/8" x 9-1/8")
Net weight	4.6-5.1 kg (10.1-11.1 lbs.)

18V x2



LXT BL XPT 1

Saw Chain, Guide Bar, Guide Bar Cover, Chain oil 100mL, Wrench, Z: Battery and Charger are sold separately

DUC357ZX4 350mm (14") Cordless Chain Saw

Consistently powerful cutting action

Li-ion Ah 6.0 5.0 3.0 1.5



Guide Bar Length	350 mm (14")
Chain Pitch / Chain Gauge	3/8" / 1.1 mm (0.043" or 0.050")
Chain Speed	7.7 m/s
Chain Oil Tank Volume	150 mL (5.1 US oz)
Sound Power Level	97 dB(A)
Dimensions (L x W x H)	762 x 214 x 234 mm (30 x 8-3/8 x 9-1/4")
Net weight	4.2-4.4 kg (9.3-9.7 lbs.)

18V



LXT BL XPT 1

Saw chain, Guide bar, Guide bar case, Round file (country-specific), Chain oil (country-specific), Battery, Charger, Z: Battery and Charger are sold separately

DUC254Z 250mm (10") Cordless Chain Saw

Efficiency equivalent to 23mL class engine chain saw

Li-ion Ah 6.0 5.0 3.0 1.5



Guide Bar Length	250 mm (10")
Chain Pitch / Chain Gauge	3/8" / 1.1 mm (0.043") / 3/8" / 1.3 mm (0.050")
Chain Speed	0-24 m/s (0-1,440 m/min) (0-4,720 FPM)
Chain Oil Tank Volume	140 mL
Sound Power Level	103.2 dB(A)
Dimensions (L x W x H)	w/o Guide Bar: 258x184x191 mm w/25 cm (10") 90PX Sprocket Nose Bar: 482x184x191 mm
Net weight	2.8-3.2 kg (6.2-6.9 lbs.)

18V



LXT BL XPT 3

Saw Chain, Guide Bar, Guide Bar Cover, Wrench, Accessory Bag, Z: Battery and Charger are sold separately



DUC150Z 150mm (6") Cordless Pruning Saw

New

Easy-to-use, compact product enables easy pruning of garden or orchard trees

Li-ion Ah 6.0 5.0 3.0 1.5



Guide bar length	150 mm (6")
Saw chain	Type: 80TXL Pitch: 0.325" Gauge: 1.1 mm (0.043")
Chain speed	8.0 m/s (480 m/min) (1,570 FPM)
Max cutting length	161 mm
Chain oil tank volume	55 mL (1.9 USoz)
Dimensions (L x W x H)	w/ BL1830B / BL1850B / BL1860B: 459 x 90 x 249 mm (18 x 3-1/2 x 9-3/4")
Net weight	1.7-2.0 kg (3.7-4.4 lbs.)

18V



Saw chain, Guide bar, Guide bar case, Round file (country-specific), Chain oil (country-specific), Battery, Charger, Z: Battery and Charger are sold separately

UC100DZ 100mm (4") Cordless Pruning Saw

Easy-to-use, compact product enables easy pruning of garden or orchard trees

Li-ion Ah 5.0 4.0 2.0 1.5



Guide bar length	100 mm (4")
Saw chain	Type: 80TXL Pitch: 0.325" Gauge: 1.1 mm (0.043")
Chain speed	8.0 m/s (480 m/min) (1,570 FPM)
Chain oil tank volume	55 mL (1.9 USoz)
Dimensions (L x W x H)	w/o Battery: 350 x 90 x 215 mm (13-3/4 x 3-1/2 x 8-1/2") w/ BL1041B: 398 x 90 x 226 mm (15-5/8 x 3-1/2 x 8-7/8")
Net weight	1.5-1.6 kg (3.3-3.5 lbs.)

12Vmax



Saw chain, Guide bar, Guide bar cover, Round file (country-specific), Chain oil (country-specific), Battery, Charger, DZ: Battery and Charger are sold separately

Lightweight yet easy-to-use

Movable guard covers the upper side of guide bar, and opens gradually wider as saw chain cuts deeper in branch.

Lock-off lever accessible from both sides



Guide bar length
150 mm

photo: DUC150

Rear hand guard

DUC150

Work amount

210 pcs.

Battery: BL1830B

Test conditions:
Cut ø50 cedar rod under an optimal pressing load of 20N or less on cutting edge. Saw chain: 80TXL



Automatic chain lubrication

New Tool-less change and tension adjustment of saw chain



UC3541A 350mm (14") / UC4041A 400mm (16") Chain Saw

Excellent in heavy duty application

152



Continuous Rating Input	1,800W
Chain Speed Per Minute	870m (2,900ft)
Saw Chain Pitch	3/8" / 1.1mm (.043")
Saw Chain Gauge	1.3mm (.050")
Sound Power Level	101.3dB(A)
Dimensions (L x W x H)	455x245x200mm
Net Weight	(17-7/8"x9-5/8"x8-7/8") 4.7kg (10.3lbs)

Dimensions: excluding blade and guide bar



Chain Blade, Guide Bar Cover, Hook Complete

UC3551A 350mm (14") / UC4051A 400mm (16") Chain Saw

Large trigger switch with soft start for smooth start-ups

153



Continuous Rating Input	2,000W
Chain Speed Per Minute	870m (2,900ft)
Guide Bar Length	UC3551A: 350mm (14")
Saw Chain Pitch	3/8"
Saw Chain Gauge	1.3mm (.050")
Sound Power Level	101.8dB(A)
Dimensions (L x W x H)	505x200x220mm
Net Weight	(19-7/8"x7-7/8"x8-5/8") 5.5kg (12.1lbs)
Power Supply Cord	0.3m (0.98ft)

Dimensions: excluding blade and guide bar



Chain Blade, Guide Bar Cover, Hook Complete

UC4551A 450mm (18") Electric Chain Saw

Heavy-duty for fast and efficient cutting

153



Continuous rating input	2,000W
Chain speed per minute	870 m (2,900 ft)
Guide Bar Length	450 mm (18")
Saw chain	Pitch: 3/8" Gauge: 1.3 mm (0.050")
Sound Power Level	101.8 dB(A)
Dimensions (L x W x H)	505x200x220 mm
Net weight	(19-7/8"x7-7/8"x8-5/8") 5.7 kg (12.4 lbs.)
Power supply cord	0.3 m (0.98 ft)

Dimensions: excluding blade and guide bar



Saw Chain, Guide Bar Cover, Hook complete

UA001GM102(RM) / GZ01 250mm (10") Cordless Pole Saw

40Vmax XGT BL AFT 25 cm (10") Cordless Pole Saw

Li-ion Ah 8.0 5.0 4.0 2.5 2.0



Guide Bar Length	250 mm (10")
Saw chain	Gauge: 1.1 - 1.3 mm (0.043 - 0.050") Pitch: 3/8"
Chain Speed	0 - 20 m/s (0 - 1,200 m/min) (0 - 3,940 FPM)
Oil Tank Capacity	160 mL
Dimensions (L x W x H)	w/o Guide Bar: 2,228 x 157 x 189 mm (87-3/4 x 6-3/16 x 7-7/16")
Net weight	6.0 - 7.3 kg (13.2 - 16.1 lbs.)



Saw Chain, Guide Bar, Guide Bar Case, Wrench, Band Assembly, Battery, Charger, Round File (country-specific), File (country-specific), Chain Oil (country-specific), Z: Battery and Charger are sold separately

UA002GM102(RM) / GZ01 250mm (10") Cordless Telescopic Pole Saw

40Vmax XGT BL AFT 25 cm (10") Cordless Telescopic Pole Saw

Li-ion Ah 8.0 5.0 4.0 2.5 2.0



Guide Bar Length	250 mm (10")
Saw chain	Gauge: 1.1 - 1.3 mm (0.043 - 0.050") Pitch: 3/8"
Chain Speed	0 - 20 m/s (0 - 1,200 m/min) (0 - 3,940 FPM)
Oil Tank Capacity	160 mL
Dimensions (L x W x H)	w/o Guide Bar: 2,515 - 3,747 x 157 x 191 mm (99 - 147-1/2 x 6-3/16 x 7-1/2")
Net weight	7.6 - 8.9 kg (16.8 - 19.6 lbs.)



Saw Chain, Guide Bar, Guide Bar Case, Wrench, Hex Wrench, Band Assembly, Battery, Charger, Round File (country-specific), File (country-specific), Chain Oil (country-specific), Z: Battery and Charger are sold separately

DUA301ZB 300mm (12") Cordless Telescopic Pole Saw

High cutting efficiency

Li-ion Ah 6.0 5.0 3.0 1.5



Guide Bar Length	300 mm (12")
Saw chain	Gauge: 1.1 / 1.3 mm (0.043 / 0.050") Pitch: 3/8"
Chain Speed	0 - 20.0 m/s (0 - 1,200 m/min) (0 - 3,940 FPM)
Oil Tank Capacity	160 mL
Dimensions (L x W x H)	2,554 - 3,789 x 155 x 193 mm (100-1/2"-149" x 6-1/8" x 7-5/8")
Net weight	7.8 - 8.5 kg



Saw Chain, Guide Bar, Blade Cover, Wrench, Band Assembly, Hex Wrench, Battery, Charger, Z: Battery and Charger are sold separately



*Saw head weight
0.7kg

Excellent tool balance

The motor is located in the battery housing at the bottom of the tool. This bottom-mounted motor reduces the saw head weight, allowing for:

- Ease to control the saw head for easy access to a desired cutting position
- Reduced user fatigue and stress

*without guide bar, saw chain and oil

No load chain speed
20.0 m/s

UA002G
Total length
2,516 - 3,748mm*

Telescopic

UA001G
Total length
2,230mm*

Fixed length

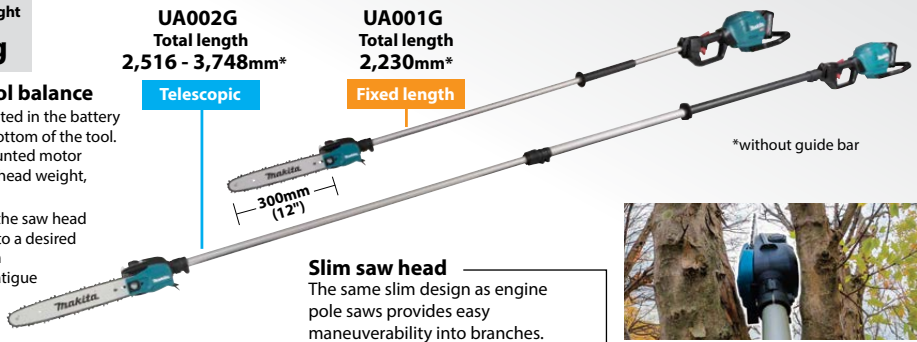

*without guide bar

Slim saw head
The same slim design as engine pole saws provides easy maneuverability into branches.



Retractable oil tank cap knob

Saw head width
87mm

DCU601Z Battery Powered Wheelbarrow (Electric Lift)

New

4-Wheel Battery Powered Wheelbarrow, Electric Lift

Li-ion Ah 6.0 5.0 3.0 1.5



Max load capacity	Flat ground (0 - 3 degrees): 300 kg (661 lbs) Slope (3 - 12 degrees): 180 kg (397 lbs)
Traveling Speed	Forward: 0-1.5/3.5/5.0 km/h Reverse: 0-1.0 km/h
Continuous use	w/ BL1860B x4: 100 min
Lift height	475 - 1,020 mm (18-3/4 - 40-1/4")
Max Climbing Capacity	12°
Dimensions (L x W x H)	1,400 x 730 x 820 - 1,030 mm
Net weight	145 kg (320 lbs.)

18V x2



LXT BL MOTOR XPT

Z: Battery and Charger are sold separately

DCU602Z Battery Powered Wheelbarrow (Electric Dump)

New

4-Wheel Battery Powered Wheelbarrow, Bucket with Electric Dump

Li-ion Ah 6.0 5.0 3.0 1.5



Max load capacity	Flat ground (0 - 3 degrees): 300 kg (661 lbs) Slope (3 - 12 degrees): 180 kg (397 lbs)
Traveling Speed	Forward: 0-1.5/3.5/5.0 km/h Reverse: 0-1.0 km/h
Continuous use	w/ BL1860B x4: 100 min
Bucket capacity	Heaped capacity: 200 L
Swivel range of dump unit	90°
Max Climbing Capacity	12°
Dimensions (L x W x H)	at its smallest: 1,480 x 730 x 820 mm
Net weight	147 kg (324 lbs.)

18V x2



LXT BL MOTOR XPT

Z: Battery and Charger are sold separately



photo: DCU601

Electric lift type



photo: DCU602

Electric dump type



(elevated to 1,020mm in approximately 30 seconds.)

- The electric lift is limited to use on a flat ground, therefore, the machine is equipped with a level gauge to check the leveling of the machine.

Loading platform size: 965 x 645 mm (L x W)

- Reduces workload when dumping soil and other materials on the ground that are too heavy to lift manually.



[Tilts electrically up to 75°]
(Tilts to 75° in approx. 30 seconds.)

- The electric dump is limited to use on a flat ground, therefore, the machine is equipped with a level gauge to check the leveling of the machine.



[Can be manually tilted for more than 75°]

Max load capacity on flat ground (0 - 3 degrees) **300 kg**

on slope (3 - 12 degrees) **180 kg**

Traveling distance **7.2 km**
with BL1860B x 4

Traveling speed change

- Selection of 3 Forward speeds and F/R rotation by push button
- Stepless variable speed control by switch trigger in each range

Forward	Reverse
3 speeds (1.5/3.5/5.0 km/h)	1 speed (1.0 km/h)

1 Hand brake lever

- Brake for speed reduction while driving the wheelbarrow
- Can be used as a parking brake by locking this lever.

2 Electric brake plus Electromagnetic brake

Electric brake

- You can minimize the chance of load collapse by releasing the switch trigger to activate soft electric brake.

Electric brake

- Powerful electromagnetic brake is activated to keep the motor braked when the driving speed decreases almost to 0km.



BL MOTOR
Max climbing ability **12°**

DCU603Z Battery Powered Wheelbarrow

18V X2 (36V) LXT BL 4-Wheel Battery Powered Wheelbarrow, 300 Kg Capacity

Li-ion Ah 6.0 | 5.0 | 3.0 | 1.5



Max load capacity	Flat ground (0 - 3 degrees): 300 kg (661 lbs) Slope (3 - 12 degrees): 180 kg (397 lbs)
Traveling Speed	Forward: 0-1.5/3.5/5.0 km/h Reverse: 0-1.0 km/h
Max Climbing Capacity	12°
Dimensions (L x W x H)	1,480 x 730 x 820 mm (32-1/4")
Net weight	122 - 124 kg (269 - 273 lbs.)

18V x2



Z: Battery and Charger are sold separately

DCU604Z Battery Powered Wheelbarrow

18V X2 (36V) LXT BL Brushless Battery Powered Wheelbarrow, 300 Kg Capacity

Li-ion Ah 6.0 | 5.0 | 3.0 | 1.5

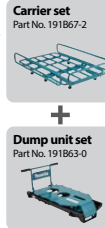

Max load capacity	Flat ground (0 - 3 degrees): 300 kg (661 lbs) Slope (3 - 12 degrees): 180 kg (397 lbs)
Traveling Speed	Forward: 0-1.5/3.5/5.0 km/h Reverse: 0-1.0 km/h
Max Climbing Capacity	12°
Dimensions (L x W x H)	1,450 x 730 x 820 mm (57 x 28-3/4 x 32-1/4")
Net weight	119 - 120 kg (262 - 265 lbs.)

18V x2



Z: Battery and Charger are sold separately

DCU605Z Battery Powered Wheelbarrow

18V X2 (36V) LXT BL Brushless Battery Powered Wheelbarrow, 300 Kg Capacity

Li-ion Ah 6.0 | 5.0 | 3.0 | 1.5



Max load capacity	Flat ground (0 - 3 degrees): 300 kg (661 lbs) Slope (3 - 12 degrees): 180 kg (397 lbs)
Traveling Speed	Forward: 0-1.5/3.5/5.0 km/h Reverse: 0-1.0 km/h
Max Climbing Capacity	12°
Dimensions (L x W x H)	1,440 x 730 x 820 mm (56-5/8 x 28-3/4 x 32-1/4")
Net weight	104 - 106 kg (229 - 234 lbs.)

18V x2



Z: Battery and Charger are sold separately



DCU180Z Battery Powered Wheelbarrow

Moving cart powered by one or two LXT Li-ion batteries

Li-ion Ah 6.0 | 5.0 | 3.0 | 1.5



Max Run Time (min)	with BL1860B: 120 130 kg (290 lbs.)
Max Load Capacity	130 kg (290 lbs.)
Traveling Speed	Forward, High / Low: 0 - 3.5 / 0 - 1.5 km/h Reverse: 0 - 1 km/h
Max Climbing Capacity	12°
Dimensions (L x W x H)	When carrier is installed / During operation: 1,315x1,060x900 mm (51-3/4"x41-3/4"x35-1/2") 39.3 - 44.8 kg (86.5 - 98.7 lbs)
Net weight	

18V



Lock Key, Support Legs, Wrenches, Z: Battery and Charger are sold separately

UH014GM101(RM) / GZ

750mm (29-1/2") Cordless Hedge Trimmer

40Vmax XGT BL Brushless Cordless 75 cm (29-1/2") Hedge Trimmer

Li-ion Ah 5.0 | 4.0 | 2.5 | 2.0



Blade Length	750 mm (29-1/2")
Max Cutting Capacity	18 mm (11/16")
Strokes Per Minute (SPM)	High / Mid / Low: 5,000 / 3,600 / 2,000
Dimensions (L x W x H)	w/o Battery: 1,225 x 270 x 135 mm w/ BL4020 / BL4025: 1,225 x 270 x 135 mm w/ BL4040: 1,225 x 270 x 150 mm w/ BL4050F: 1,225 x 270 x 168 mm
Net weight	4.0 - 4.7 kg (8.8 - 10.4 lbs.)

40Vmax



Blade Cover, Safety Goggles (country-specific), Chip Receiver, Battery, Charger, Z: Battery and Charger are sold separately

UH006GZ 600mm (23-5/8") Cordless Hedge Trimmer

Reliable cutting performance like engine/AC hedge trimmers

Li-ion Ah 5.0 | 4.0 | 2.5 | 2.0



Blade Length	600 mm (23-5/8")
Max Cutting Capacity	25.0 mm (1")
Strokes Per Minute (SPM)	High / Mid / Low: 4,000 / 3,000 / 2,000
Sound Pressure Level	81 dB(A)
Sound Power Level	92 dB(A)
Vibration Level	Front / Rear: 3.0 / 2.5 m/s ² or less w/ BL4020 / BL4025: 1,123 x 223 x 191 mm (44-1/4 x 8-3/4 x 7-1/2")
Dimensions (L x W x H)	
Net weight	4.4 - 5.0 kg (9.7 - 11.0 lbs.)

40Vmax



Blade Cover, Safety goggles (country-specific), Chip Receiver, Battery, Charger, Z: Battery and Charger are sold separately

DUH754SZ 750mm (29-1/2") Cordless Hedge Trimmer

18V LXT BL Brushless Cordless 75 cm (29-1/2") Hedge Trimmer

Li-ion Ah 6.0 | 5.0 | 3.0 | 1.5



Blade Length	750 mm (29-1/2")
Max Cutting Capacity	23.5 mm (15/16")
Sound Pressure Level	80.6 dB(A)
Sound power level	91.6 dB(A)
Vibration Level	2.5 m/s ² or less
Strokes Per Minute (SPM)	High / Med / Low: 0 - 4,400 / 0 - 3,600 / 0 - 2,000
Dimensions (L x W x H)	1,198x280x147 mm (47-1/4"x11"x5-3/4")
Net weight	4.1 kg (9.0 lbs.)

18V



Blade Cover, Safety Goggles (country-specific), Chip Receiver (country-specific), Battery, Charger, Z: Battery and Charger are sold separately

DUH604SZ 600mm (23-5/8") Cordless Hedge Trimmer

18V LXT BL Brushless Cordless 60 cm (23-5/8") Hedge Trimmer

Li-ion Ah 6.0 5.0 3.0 1.5



Blade Length	600 mm (23-5/8")
Max Cutting Capacity	23.5 mm (15/16")
Sound Pressure Level	79.3 dB(A)
Sound power level	90.3 dB (A)
Vibration Level	2.5 m/s ² or less
Strokes Per Minute (SPM)	High / Med / Low: 0 - 4,400 / 0 - 3,600 / 0 - 2,000
Dimensions (L x W x H)	1,057x280x147 mm (41-1/2"x11"x5-3/4")
Net weight	4.0 kg (8.8 lbs.)

18V



LXT BL XPT 1

Blade Cover, Safety Goggles (country-specific), Chip Receiver (country-specific), Battery, Charger, Z: Battery and Charger are sold separately

DUH751Z 750mm (29-1/2") Cordless Hedge Trimmer

18V LXT BL Brushless Cordless 75 cm (29-1/2") Hedge Trimmer

Li-ion Ah 6.0 5.0 3.0 1.5



Blade Length	750 mm (29-1/2")
Strokes Per Minute (SPM)	High / Med / Low: 0 - 4,400 / 0 - 3,600 / 0 - 2,000
Vibration Level	2.5 m/s ²
Sound Power Level	97 dB(A)
Dimensions (L x W x H)	1,261x225x192 mm (49-1/2"x8-7/8"x7-1/2")
Net weight	3.8 - 4.5 kg (8.4 - 9.8 lbs.)

18V



LXT BL XPT 1

Blade Cover, Safety Goggles (country-specific), Chip Receiver (country-specific), Battery, Charger, Z: Battery and Charger are sold separately

DUH601Z 600mm (23-5/8") Cordless Hedge Trimmer

18V LXT BL Brushless Cordless 60 cm (23-5/8") Hedge Trimmer

Li-ion Ah 6.0 5.0 3.0 1.5



Blade Length	600 mm (23-5/8")
Strokes Per Minute (SPM)	High / Med / Low: 0 - 4,400 / 0 - 3,600 / 0 - 2,000
Vibration Level	2.5 m/s ² or less
Sound Power Level	95 dB(A)
Dimensions (L x W x H)	1,121x225x192 mm (44-1/4"x8-7/8"x7-1/2")
Net weight	3.8 - 4.5 kg (8.4 - 9.8 lbs.)

18V



LXT BL XPT 1

Blade Cover, Safety Goggles (country-specific), Chip Receiver, Battery, Charger, Z: Battery and Charger are sold separately

DUH502Z 500mm (19-3/4") Cordless Hedge Trimmer

18V LXT BL Brushless Cordless 50 cm (19-3/4") Hedge Trimmer

Li-ion Ah 6.0 5.0 3.0 1.5



Blade Length	500 mm (19-5/8")
Strokes Per Minute (SPM)	High / Med / Low: 0 - 4,400 / 0 - 3,600 / 0 - 2,000
Vibration Level	2.5 m/s ²
Sound Power Level	86.8 dB(A)
Dimensions (L x W x H)	1,016x225x192 mm (40"x8-7/8"x7-1/2")
Net weight	3.7 - 4.4 kg (8.2 - 9.7 lbs.)

18V



LXT BL XPT 1

Blade Cover, Safety Goggles (country-specific), Battery, Charger, Z: Battery and Charger are sold separately

DUH606Z 600mm (23-5/8") Cordless Hedge Trimmer

18V LXT BL Brushless Cordless 60 cm (23-5/8") Hedge Trimmer

Li-ion Ah 6.0 5.0 3.0 1.5



Blade Length	600 mm (23-5/8")
Max Cutting Capacity	20.0 mm (13/16")
Strokes Per Minute (SPM)	4,000
Continuous Use (min.)	w/ BL1860B: 70
Dimensions (L x W x H)	1,016 x 207 x 185 mm (40 x 8-1/8 x 7-1/4")
Net weight	2.7 - 3.0 kg (6.0 - 6.6 lbs.)

18V



LXT BL XPT 1

Blade Cover, Battery, Charger, Z: Battery and Charger are sold separately

DUH506Z 500mm (19-3/4") Cordless Hedge Trimmer

18V LXT BL Brushless Cordless 50 cm (19-3/4") Hedge Trimmer

Li-ion Ah 6.0 5.0 3.0 1.5



Blade Length	500 mm (19-5/8")
Max Cutting Capacity	20.0 mm (13/16")
Strokes Per Minute (SPM)	4,000
Continuous Use (min.)	w/ BL1860B: 75
Dimensions (L x W x H)	897 x 207 x 185 mm (35-1/4 x 8-1/8 x 7-1/4")
Net weight	2.5 - 2.9 kg (5.5 - 6.4 lbs.)

18V



LXT BL XPT 1

Blade Cover, Battery, Charger, Z: Battery and Charger are sold separately



DUH507F001 / Z 500mm (19-3/4") Cordless Hedge Trimmer

Large main switch lever for improved switch operation

Li-ion Ah 6.0 5.0 3.0 1.5



Blade Length	500 mm (19-5/8")
Effective cutting length	498 mm (19-5/8")
Max branch dia.	15 mm (9/16")
Tooth spacing	28 mm (1-1/8")
Strokes Per Minute (SPM)	2,700
Continuous Use (min.)	w/ BL1830B: 77
Dimensions (L x W x H)	w/ BL1830B / BL1850B / BL1860B: 925 x 209 x 188 mm (36-1/2 x 8-1/4 x 7-3/8")
Net weight	2.7 - 3.0 kg (6.0 - 6.6 lbs.)

18V



LXT XPT 1

Blade cover, Battery, Charger, Z: Battery and Charger are sold separately

UH353DSA / DZ 350mm (13-3/4") Cordless Hedge Trimmer

Lightweight, Low Vibration, Low Noise

Li-ion Ah 5.0 4.0 2.0 1.5



Max Output Power	170W
Cycles Per Minute (cpm)	1,650
Strokes Per Minute (SPM)	3,300
Cutting width	350 mm (13-3/4")
Max Cutting Capacity	15mm (9/16)
Dimensions (L x W x H)	693 x 175 x 165mm (27-1/4 x 6-7/8 x 6-1/2)
Net weight	2 - 2.1 kg (4.3 - 4.7 lbs.)

12Vmax



Blade Cover, Battery, Charger, DZ: Battery and Charger are sold separately

DUN500WZ 500mm (19-3/4") Cordless Pole Hedge Trimmer

18V LXT BL Brushless Cordless Pole Hedge Trimmer

Li-ion Ah 6.0 5.0 3.0 1.5



Blade Length	500 mm (19-3/4")
Max Cutting Capacity	23.5 mm (15/16")
Sound Pressure Level	81.5 dB(A)
Sound Power Level	92.5 dB (A)
Vibration Level	
Left hand (Front grip / Handle)	4.7 m/s2
Right hand (Rear grip)	2.5 m/s2 or less
Strokes Per Minute (SPM)	High / Med / Low: 4,400 / 3,600 / 2,000
Overall length	2,115 mm
Net weight	4.5 kg (9.9 lbs.)

18V



Blade Cover, Harness, Battery, Charger, Z: Battery and Charger are sold separately



Length adjustable telescopic system



Blade length: 460mm

Angle adjustable hedge trimmer head

- 60° tilt-up to 75° tilt-down from the horizontal position.
- 10 angle settings (60°, 45°, 30°, 15°, 0°, -15°, 30°-45°, -60°, 75°)

photo: DUN461W

Slide-type front grip position is adjustable for personal fit and comfort maximum work efficiency in different working postures

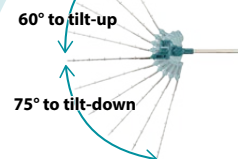

Strokes per minute

High speed mode (No load speed)

3,600 min⁻¹

Run time*

DUN461W / UN460WD
BL1850B / BL1041B

122 / 53 min

DUN461WSF / WZ 460mm (18-1/8") Cordless Pole Hedge Trimmer

Telescopic pipe for no need of stepladders

Li-ion Ah 6.0 5.0 3.0 1.5



Blade Length	460 mm (18-1/8")
Max Cutting Capacity	18 mm (11/16")
Strokes Per Minute (SPM)	3,600
Cycles Per Minute (CPM)	1,800
Continuous Use (min.)	w/BL1830B: 60
Dimensions (L x W x H)	1,889 - 2,511 x 87 x 133 mm (74-1/2 - 99 x 3-7/16 x 5-1/4")
Net weight	w/BL1860B: 3.4 kg (7.5 lbs.)

18V



Blade Cover, Chip Receiver (country-specific), Shear Blade (country-specific), Battery, Charger, Z: Battery and Charger are sold separately

UN460WDWA / WDZ 460mm (18-1/8") Cordless Pole Hedge Trimmer

12Vmax LXT Cordless 46 cm (18-1/8") Pole Hedge Trimmer

Li-ion Ah 5.0 4.0 2.0 1.5



Blade Length	460 mm (18-1/8")
Max Cutting Capacity	18 mm (11/16")
Strokes Per Minute (SPM)	3,600
Cycles Per Minute (CPM)	1,800
Dimensions (L x W x H)	1,889 - 2,511 x 87 x 133 mm (74-1/2 x 99 x 3-7/16 x 5-1/4")
Net weight	3.0 kg (6.6 lbs.)

12Vmax



Blade Cover, Chip Receiver (country-specific), Shear Blade (country-specific), Battery, Charger, DZ: Battery and Charger are sold separately

UH201DZ 200mm (7-7/8") Cordless Hedge Trimmer

12Vmax CXT Li-Ion Cordless 20 cm (7-7/8") Hedge Trimmer

Li-ion Ah 5.0 4.0 2.0 1.5



Blade Length	200 mm (7-7/8")
Strokes Per Minute (SPM)	2,500
Dimensions (L x W x H)	504 x 120 x 131 mm (19-7/8 x 4-3/4 x 5-1/8")
Net Weight	1.3 - 1.5 kg (2.8 - 3.3 lbs)

12Vmax



Base Frame, Blade Cover, Battery, Charger, DZ: Battery and Charger are sold separately

DUM604SF / Z 160mm (6-5/16") Cordless Grass Shear

18V LXT Li-Ion Cordless 16 cm (6-5/16") Grass Shear

Li-ion Ah 6.0 5.0 3.0 1.5



Cutting Width	160 mm (6-5/16")
Depth Adjustment	15, 20, 25 mm (9/16"; 13/16"; 1")
Strokes Per Minute (SPM)	2,500
Continuous Use (min.)	with BL1860B / BL1850B / BL1840B / BL1830B / BL1820B / BL1815N: 250 / 200 / 160 / 125 / 80 / 60
Dimensions (L x W x H)	337x177x131 mm (13-1/4"x7"x5-1/8")
Net weight	1.4 - 1.8 kg (3.2 - 4.0 lbs)

18V



Grass Receiver, Blade Cover, Z: Battery and Charger are sold separately

DUM111SYX 110mm Cordless Grass Shear

11 cm cutting width for optimum performance

Li-ion Ah 6.0 | 5.0 | 3.0 | 1.5



Cutting Width	110 mm
Strokes Per Minute (SPM)	2,500
Continuous Use (min.)	with BL1860B / BL1850B / BL1830B / BL1820B / BL1815N: - / - / - / - / 45
Dimensions (L x W x H)	333 x 120 x 131 mm
Net weight	1.4 - 1.7 kg (3.2 - 3.8 lbs.)

18V



Blade Cover, Battery, Charger, Z: Battery and Charger are sold separately

UM600DSYEX / DWA / DZ 160mm (6-5/16") Cordless Grass Shear

12Vmax CXT Li-Ion Cordless 16 cm (6-5/16") Grass Shear

Li-ion Ah 5.0 | 4.0 | 2.0 | 1.5



UM600DSYEX

Cutting Width	160 mm (6-5/16")
Strokes Per Minute (SPM)	2,500
Dimensions (L x W x H)	329 x 177 x 131 mm (13" x 7" x 5-1/8")
Net Weight	1.3 - 1.5 kg (2.8 - 3.3 lbs)

12Vmax



Base Frame, Blade Cover, Battery, Charger, DZ: Battery and Charger are sold separately

Tool-less blade change system

- Grass shear blade can be removed / installed without tool.
- Hedge trimmer blade can be removed / installed by using a coin to loosen / tighten two screws.



UR012GZ04 Cordless Grass Trimmer

80Vmax XGT BL ADT AFT Cordless 3-Speed Grass Trimmer, Bike Handle

Li-ion Ah 8.0 | 5.0 | 4.0 | 2.5 | 2.0



Cutting Width	Metal Blade: 305 mm TCT Saw Blade: 255 mm Chisel Blade: 225 mm Nylon Cutting Head: 480 mm Shredder Blade: 270 mm Plastic Blade: 305 mm
No Load Speed (RPM)	Metal Blade (3/2/1): 0 - 6,800 / 0 - 5,000 / 0 - 3,500 Nylon Cutting Head (3/2/1): 0 - 5,000 / 0 - 4,200 / 0 - 3,500 Plastic Blade (3/2/1): 0 - 6,800 / 0 - 5,000 / 0 - 3,500
Spindle Size	M10 x 1.25 LH
Net weight	8.0 - 9.3 kg (17.6 - 20.5 lbs.)

40Vmax x2



Safety Goggles, Metal Blade / Nylon Cutting Head / Plastic Blade (country-specific), Blade Cover (for the product with metal blade), Accessory Bag, Hex Wrench, Box Wrench, Shoulder Belt, Battery, Charger, Z: Battery and Charger are sold separately

UR013GZ03 Cordless Grass Trimmer

40Vmax XGT BL AFT Cordless Grass Trimmer, Bike Handle

Li-ion Ah 8.0 | 5.0 | 4.0 | 2.5 | 2.0



Cutting Width	Metal Blade: 255 mm Chisel Blade: 225 mm Nylon Cutting Head: 450 mm Shredder Blade: 270 mm Plastic Blade: 305 mm
No Load Speed (RPM)	0 - 6,700
Spindle Size	M10 x 1.25 LH
Dimensions (L x W x H)	1,905 x 688 x 574 mm (75 x 27 x 22-5/8")
Net weight	5.9 - 7.3 kg (13.0 - 16.1 lbs.)

40Vmax



Metal blade / Nylon cutting head / Plastic blade (country-specific), Tool cover (country-specific), Accessory bag, Hex wrench, Box driver, Shoulder belt, Battery, Charger, Z: Battery and Charger are sold separately

UR008GM101(RM) / GZ01 Cordless Grass Trimmer

40Vmax XGT BL ADT AFT Cordless 3-Speed Grass Trimmer, Loop Handle

Li-ion Ah 8.0 | 5.0 | 4.0 | 2.5 | 2.0



Cutting Width	Nylon Cutting Head: 430 mm (17") Plastic Blade: 305 mm (12")
No Load Speed (RPM)	Nylon Cutting Head (3/2/1): 0 - 5,000 / 0 - 4,600 / 0 - 4,000 Plastic Blade (3/2/1): 0 - 6,000 / 0 - 4,600 / 0 - 4,000
Spindle Size	M10 x 1.25 LH
Dimensions (L x W x H)	w/o Cutting Tool, w/o Battery: 1,803 x 224 x 300 mm (71 x 8-7/8 x 11-3/4")
Net weight	5.0 - 5.7 kg (11.0 - 12.6 lbs.)

40Vmax

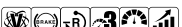

Safety Goggles, Nylon Cutting Head, Accessory Bag, Hex Wrench, Battery, Charger, Z: Battery and Charger are sold separately

UR003GZ Cordless Grass Trimmer

40Vmax XGT BL ADT AFT Cordless 3-Speed Grass Trimmer, Loop Handle

Li-ion Ah 8.0 | 5.0 | 4.0 | 2.5 | 2.0



Cutting Width	Metal Blade: 230 mm (9") Nylon Cutting Head: 350 mm (13-3/4") Plastic Blade: 255 mm (10")
No Load Speed (RPM)	High / Mid / Low: 0 - 6,500 / 5,300 / 3,500
Spindle Size	M10 x 1.25 LH
Dimensions (L x W x H)	w/o Cutting Tool, w/BL4020 / BL4025 / BL4040: 1,735 x 355 x 230 mm (68-1/4 x 14 x 9")
Net weight	4.1 - 4.7 kg (9.0 - 10.4 lbs.)

40Vmax

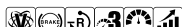

Safety Goggles, Metal Blade / Nylon Cutting Head / Plastic Blade (country-specific), Blade Cover (for the product with metal blade), Accessory Bag, Hex Wrench, Box Driver, Shoulder Belt, Battery, Charger, Z: Battery and Charger are sold separately

UR017GZ Cordless Grass Trimmer

40Vmax XGT BL ADT AFT Cordless 3-Speed Grass Trimmer, Loop Handle

Li-ion Ah 5.0 4.0 2.5 2.0



Cutting Width	Metal blade: 230 mm (9")
	Nylon cutting head: 330 mm (13")
	Plastic blade: 255 mm (10")
No Load Speed (RPM)	High / Med. / Low: 6,500 / 5,300 / 3,500
Spindle size	M10 x 1.25 LH
Dimensions (L x W x H)	1,890 x 362 x 265 mm (74-1/2 x 14-1/4 x 10-3/8")
Net weight	4.2 - 4.8 kg (9.3 - 10.6 lbs.)

40Vmax



XGT BL ADT AFT XPT



Nylon cutting head, Plastic blade, Shoulder belt, Box driver, Hex wrench, Accessory bag, Battery, Charger, Z: Battery and Charger are sold separately



Grass tangle removing function

Reverse switch for clearing entangled weeds and grass from cutting head

Lightweight design

4.8 kg

with battery BL4050F without Cutting tool and Shoulder strap

photo: UR017G

UR202CZ Battery Powered Grass Trimmer

BL ADT AFT Battery Powered 3-Speed Grass Trimmer



Cutting Width	Nylon cutting head: 430 mm (17")
	Plastic blade: 305 mm (12")
No Load Speed (RPM)	Nylon cutting head (3 / 2 / 1): 0 - 5,000 / 0 - 4,600 / 0 - 4,000
Spindle Size	M10 x 1.25 LH
Dimensions (L x W x H)	1,783 x 226 x 300 mm (70-1/4 x 8-15/16 x 11-7/8")
Net weight	5.5 - 6.1 kg (12.1 - 13.5 lbs.)

40Vmax



BL ADT AFT XGT



Safety Goggles, Metal Blade / Nylon Cutting Head / Plastic Blade (country-specific), Blade cover (for the product with metal blade), Accessory Bag, Hex Wrench, Box Driver, Shoulder Belt, Battery, Charger

DUR369LZ Cordless Grass Trimmer

18V X2 (36V) LXT BL ADT AFT Cordless 3-Speed Grass Trimmer

Li-ion Ah 6.0 5.0 3.0 1.5



Cutting Width	Metal Blade: 255 mm (10")
	Trimmer Head: 430 mm (17")
	Plastic Blade: 305 mm (12")
No Load Speed (RPM)	High / Med / Low: 3,300-7,000 / 5,500 / 4,600
Spindle Size	M10 x 1.25 LH
Dimensions (L x W x H)	1,846 x 400 x 269 mm (72-1/2" x 15-3/4" x 10-5/8")
Net weight	5.8 - 6.4 kg (12.8 - 14.1 lbs.)

18V x2

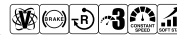

LXT BL ADT AFT XPT



Safety Goggles, Metal Blade / Nylon Cutting Head / Plastic Blade (country-specific), Blade cover (for the product with metal blade), Accessory Bag, Hex Wrench, Shoulder Belt, Battery, Charger

DUR368LZ Cordless Grass Trimmer

18V X2 (36V) LXT BL ADT AFT Cordless 3-Speed Grass Trimmer

Li-ion Ah 6.0 5.0 3.0 1.5



Cutting Width	Metal Blade: 255 mm (10")
	Trimmer Head: 350 mm (13-3/4")
	Plastic Blade: 255 mm (10")
No Load Speed (RPM)	High / Med / Low: 6,500 / 5,300 / 3,500
Spindle Size	M10 x 1.25 LH
Sound Power Level	4-Tooth Blade: 89.2 dB(A) Nylon Cutting Head: 89 dB(A)
Dimensions (L x W x H)	1,758 x 362 x 231 mm (69-1/4" x 14-1/4" x 9-1/8")
Net weight	3.9 - 4.5 kg (8.6 - 10.0 lbs.)

18V x2



LXT BL ADT AFT XPT



Safety Goggles, Metal Blade / Nylon Cutting Head / Plastic Blade (country-specific), Blade cover (for the product with metal blade), Accessory Bag, Hex Wrench, Box Driver, Shoulder Belt, Battery, Charger

DUR189Z Cordless Grass Trimmer

18V LXT BL ADT Cordless Grass Trimmer, Short Telescopic Pipe, Loop Handle

Li-ion Ah 6.0 5.0 3.0 1.5



Cutting Width	Trimmer Head: 300 mm (11-3/4")
	Plastic Blade: 255 mm (10")
No Load Speed (RPM)	High / Mid / Low / ADT Mode: 6,000 / 5,000 / 4,000 / 4,000 - 6,000
Spindle Size	M8 x 1.25 RH
Max Run Time (min)	Nylon Cutting Head, BL1860B: 168 Plastic Blade, BL1860B: 219
Net weight	3 - 3.3 kg (6.6 - 7.3 lbs.)

18V



LXT BL ADT XPT



Shoulder Strap, Nylon Cutting Head, Plastic Blade, Safety Goggles, Accessory Bag, Hex Wrench, Battery, Charger, Z: Battery and Charger are sold separately

DUR194SFX2 Cordless Grass Trimmer

18V LXT Li-Ion Cordless 2-Speed Grass Trimmer, Loop Handle

Li-ion Ah 6.0 5.0 3.0 1.5



Cutting Width	Metal Blade: 200 mm (7-7/8")
	Trimmer Head: 280 mm (11")
	Plastic Blade: 230 mm (9")
No Load Speed (RPM)	High / Low: 6,000 / 4,500
Spindle Size	M10 x 1.25 LH
Dimensions (L x W x H)	1,630 x 288 x 236 mm (64 x 11-3/8 x 9-1/4")
Net weight	2.6 - 2.9 kg (5.7 - 6.4 lbs.)

18V



Safety Goggles (country-specific), Shoulder Belt, Nylon Cutting Head, Metal Blade / Nylon Cutting Head / Plastic Blade (country-specific), Hex Wrench, Box Driver, Accessory Bag, Battery, Charger, Z: Battery and Charger are sold separately

DUR193SF / Z Cordless Grass Trimmer

18V LXT Li-Ion Cordless Grass Trimmer

Li-ion Ah 6.0 5.0 3.0 1.5



Cutting Width	Trimmer Head: 260 mm (10-1/4")
No Load Speed (RPM)	7,800
Max Run Time (min)	w/ BL1830B: 45
Dimensions (L x W x H)	1,194 - 1,384 x 271 x 372 mm (47 - 54-1/2 x 10-5/8 x 14-5/8")
Net weight	2.4 - 2.7 kg (5.3 - 6.0 lbs.)

18V



Safety Goggles (country-specific), Shoulder Belt, Nylon Cutting Head, Metal Blade / Nylon Cutting Head / Plastic Blade (country-specific), Hex Wrench, Box Driver, Accessory Bag, Battery, Charger, Z: Battery and Charger are sold separately

DUR181Z Cordless String Trimmer

18V LXT Li-Ion Cordless String Trimmer

Li-ion Ah 6.0 | 5.0 | 3.0 | 1.5



Cutting Width	Trimmer Head: 260 mm (10-1/4")
No Load Speed (RPM)	7,800
Sound Power Level	88.5 dB(A)
Dimensions (L x W x H)	1,229 - 1,433 x 267 x 186 - 257 mm (48-1/2 - 56-1/2" x 10-1/2" x 7-3/8 - 10-1/8")
Max Run Time (min)	with BL1830B: 45
Net weight	2.8 - 3.1 kg (6.2 - 6.9 lbs)

18V



Safety Goggles, Shoulder Belt, Nylon Cutting Head, Nylon Cord, Battery, Fast Charger
Z: Battery and Charger are sold separately

UR100DWA / DZ Cordless Grass Trimmer

Compact size is ideal for trimming and precise edging

Li-ion Ah 5.0 | 4.0 | 2.0 | 1.5



Cutting Width	Nylon Cutting Head: 260 mm (10") Plastic Blade: 230 mm (9")
No Load Speed (RPM)	10,000
Spindle Size	M8 x 1.25 RH
Dimensions (L x W x H)	835 - 1,195 x 267 x 210 - 315
Net weight	1.9 - 2.1 kg (4.3 - 4.6 lbs.)

12Vmax



Safety Goggles, Shoulder Belt, Nylon Cutting Head, Nylon Cord, Plastic Blade, Accessory Bag, Hex Wrench, Battery, Charger, DZ: Battery and Charger are sold separately

UR3000 300mm (11-3/4") String Trimmer

Lightweight AC string trimmers for do-it-yourselfers



Continuous Rating Input	450W
Cutting Width	300 mm (11-3/4")
No Load Speed (RPM)	9,000
Sound Power Level	96 dB(A)
Dimensions (L x W x H)	1,016 - 1,256 x 301 x 262 mm (40 - 49-1/2" x 11-7/8" x 10-3/8")
Net Weight	2.6 kg (5.7 lbs)
Power Supply Cord	10m



Extension Cord with Lock, Shoulder Strap, Safety Goggles, Nylon Cord

LM004JZ 530mm (21") Cordless Lawn Mower

3 cutting modes (Normal/ Soft no-load/ Noise reduction)

Li-ion Ah 10.0 | 4.0



Cutting Width	534 mm (21")
Cutting Height	20 - 100 mm (13/16 - 3-15/16")
Grass Box Capacity	70 L
No Load Speed (RPM)	2,300 - 2,800
Propelling speed	1.5 - 6.5 km/h 39
Wheel diameter	230 / 230 mm (9 / 9")
Dimensions (L x W x H)	1,740 - 1,810 x 595 x 970 - 1,080 mm (68-1/2 - 71-1/4 x 23-1/2 x 38-1/4 - 42-1/2")
Net weight	31.5 - 34.6 kg (69.5 - 76.3 lbs.)

64Vmax



Blade, Mulching plug, Socket wrench, Rod, Discharge chute, Battery, Charger,
Z: Battery and Charger are sold separately



BL64100
Powerful Li-Ion battery with 564.48Wh energy capacity

Greater Power Performance

BL6440 (4.0Ah)
BL64100 (10.0Ah)
Battery

DC64WA
Charger

64Vmax



photo: LM004J

Continuous run time
Push-Drive / Self-propelled

81/59 min

Battery: BL64100 on a full battery charge

LM002JM101 530mm (21") Cordless Lawn Mower

High power cordless lawn mower powered by 64Vmax (57.6V) Li-Ion battery

Li-ion Ah 10.0 | 4.0



Cutting Width	534 mm (21")
Cutting Height	20 - 100 mm (13/16 - 3-15/16")
Grass Box Capacity	70 L
No Load Speed (RPM)	2,300 - 2,800
Actual Mowing Area	1,600 m ²
Continuous Use (min.)	39
Vibration Level	2.5 m/s ² or less
Dimensions (L x W x H)	1,710 - 1,800 x 585 x 985 - 1,115 mm (67-1/2 - 71 x 23 x 38-3/4 - 44")
Net weight	25.7 - 27.6 kg

64Vmax



Blade, Mulching Plug, Socket Wrench, Rod, Battery, Charger

LM001JM101 480mm (18-7/8") Cordless Lawn Mower

High power cordless lawn mower powered by 64Vmax (57.6V) Li-Ion battery

Li-ion Ah 10.0 | 4.0



Cutting Width	480 mm (18-7/8")
Cutting Height	20 - 100 mm (13/16 - 3-15/16")
Grass Box Capacity	62 L
No Load Speed (RPM)	2,500 - 3,200
Actual Mowing Area	1,400 m ²
Continuous Use (min.)	34
Vibration Level	2.5 m/s ² or less
Dimensions (L x W x H)	1,600 - 1,680 x 540 x 955 - 1,080 mm (63 - 66 x 21-1/4 x 37-1/2 - 42-1/2")
Net weight	24.4 - 26.1 kg

64Vmax



Blade, Mulching Plug, Socket Wrench, Rod, Battery, Charger

LM002GZ 530mm (21") Cordless Lawn Mower

40Vmax XGT BL Cordless 53 cm (21") Self-Propelled Lawn Mower

Li-ion Ah 8.0 | 5.0 | 4.0 | 2.5 | 2.0



Cutting Width	534 mm (21")
Cutting Height	20 - 100 mm (13/16 - 3-15/16")
Grass Box Capacity	70 L
No Load Speed (RPM)	2,300 - 2,800
Propelling speed	1.5 - 5.0 km/h
Wheel diameter	230 / 230 mm (9 / 9")
Dimensions (L x W x H)	During operation: 1,740 - 1,810 x 595 x 970 - 1,080 mm (68-1/2 - 71-1/4 x 23-1/2 x 38-1/4 - 42-1/2")
Net weight	29.5 - 34.7 kg (65.0 - 76.5 lbs.)

40Vmax



Blade, Mulching plug, Socket wrench, Rod, Discharge chute, Battery, Charger, Z: Battery and Charger are sold separately

LM001GZ 480mm (18-7/8") Cordless Lawn Mower

40Vmax XGT BL Cordless 48 cm (18-7/8") Self-Propelled Lawn Mower

Li-ion Ah 8.0 | 5.0 | 4.0 | 2.5 | 2.0



Cutting Width	480 mm (18-7/8")
Cutting Height	20 - 100 mm (13/16 - 3-15/16")
Grass Box Capacity	62 L
No Load Speed (RPM)	2,500 - 3,200
Propelling speed	1.5 - 5.0 km/h
Wheel diameter	230 / 230 mm (9 / 9")
Dimensions (L x W x H)	During operation: 1,670 - 1,745 x 550 x 965 - 1,075 mm (65-3/4 - 68-3/4 x 21-5/8 x 38 - 42-1/4")
Net weight	28.0 - 33.0 kg (61.7 - 72.8 lbs.)

40Vmax



Blade, Mulching plug, Socket wrench, Rod, Discharge chute, Battery, Charger, Z: Battery and Charger are sold separately

LM004GZ 430mm (17") Cordless Lawn Mower

New

40Vmax XGT BL Cordless 43 cm (17") Lawn Mower

Li-ion Ah 8.0 | 5.0 | 4.0 | 2.5 | 2.0



Cutting Width	430 mm (17")
Cutting Height	20 - 75 mm (13/16 - 2-15/16")
Grass Box Capacity	50 L
No Load Speed (RPM)	3,800 min ⁻¹
Continuous use (approx.) on a full battery charge	w/ BL4080F: 52 min
Wheel diameter	140 / 165 mm
Dimensions (L x W x H)	During operation: 1,390 - 1,440 x 460 x 990 - 1,020 mm
Net weight	15.6 - 18.2 kg (34.4 - 40.1 lbs.)

40Vmax



Socket wrench, Blade, Mulching plug, Grass catcher, Battery, Charger, Z: Battery and Charger are sold separately

LM003GZ 380mm (15") Cordless Lawn Mower

New

40Vmax XGT BL Cordless 38 cm (15") Lawn Mower

Li-ion Ah 8.0 | 5.0 | 4.0 | 2.5 | 2.0



Cutting Width	380 mm (15")
Cutting Height	20 - 75 mm (13/16 - 2-15/16")
Grass Box Capacity	40 L
No Load Speed (RPM)	3,800 min ⁻¹
Continuous use (approx.) on a full battery charge	w/ BL4080F: 49 min
Wheel diameter	140 / 165 mm
Dimensions (L x W x H)	During operation: 1,370 - 1,420 x 450 x 990 - 1,020 mm
Net weight	14.9 - 17.3 kg (32.8 - 38.1 lbs.)

40Vmax



Socket wrench, Blade, Mulching plug, Grass catcher, Battery, Charger, Z: Battery and Charger are sold separately

Powered by 40Vmax XGT Li-Ion battery



Continuous use*

LM003G (380mm)

LM004G (430mm)

about

about

49 min

52 min

Mowing area*

LM003G (380mm)

LM004G (430mm)

about

780 m²

about

830 m²

*on a full battery charge (with BL4080F)



Grass level indicator



Warning lamp for Battery capacity, High temperature and Overload

Grass catcher capacity	
LM003G	LM004G
40L	50L

Photo: LM004G

Cutting, Collecting, Mulching*

*Mulching plug required.

Easier cutting height adjustment

Higher mowing performance

The blade is designed to tilt down towards the front of the mower when attached, minimizing double-cutting to reduce the load on the machine for reduced energy consumption, better feeling of cutting and improved grass collecting performance.



LM001CZ 534mm (21") Battery Powered Lawn Mower

Mows 5,700 m² with PDC1200



Cutting Width	534 mm (21")
Cutting Height	20-100 mm (13/16"-3-15/16")
No Load Speed (RPM)	2,300-2,800
Propelling Speed	2.5-5.0 km/h
Actual Mowing Area	w/ PDC01, Self-Propelled: 1,700 m ²
	w/ PDC01, push-drive: 2,300 m ²
	w/ PDC1200, Self-Propelled: 4,200 m ²
	w/ PDC1200, push-drive: 5,700 m ²
Continuous Use (min.)	w/ PDC01, Self-Propelled: 40
	w/ PDC01, push-drive: 50
	w/ PDC1200, Self-Propelled: 100
	w/ PDC1200, push-drive: 130
Dimensions (L x W x H)	1,630-1,715 x 590 x 990-1,095 mm
Net weight	41.9-49.2 kg (92.4-108.5 lbs.)



Blade, Mulching plug, Side discharge mouth, Socket wrench, Rod

DLM539Z 534mm (21") Cordless Lawn Mower

18V X2 (36V) BL Brushless Cordless 53 cm (21") Lawn Mower



Li-ion Ah 6.0 5.0 3.0 1.5

Cutting Width	534 mm (21")
Cutting Height	20-100 mm (13/16"-3-15/16")
No Load Speed (RPM)	3,000
Propelling Speed	2.5-5.0 km/h
Actual Mowing Area	w/ BL1860B x2, Self-Propelled: 700 m ²
	w/ BL1860B x2, Push-Drive: 800 m ²
Continuous Use (min.)	w/ BL1860B x2, Self-Propelled: 22
	w/ BL1860B x2, Push-Drive: 25
Dimensions (L x W x H)	During Operation: 1,810-1,870 x 580 x 920 - 1,040 mm
Net weight	28.0-30.5 kg



Blade, Mulch Plug, Socket Wrench, Rod, Battery, Charger, Z: Battery and Charger are sold separately

DLM538Z 534mm (21") Cordless Lawn Mower

18V X2 (36V) BL Brushless Cordless 53 cm (21") Lawn Mower



Li-ion Ah 6.0 5.0 3.0 1.5

Cutting Width	534 mm (21")
Cutting Height	20-100 mm (13/16"-3-15/16")
No Load Speed (RPM)	3,000
Actual Mowing Area	w/ BL1860B x2, Push-Drive: 800 m ²
Continuous Use (min.)	w/ BL1860B x2, Push-Drive: 25
Dimensions (L x W x H)	During Operation: 1,810-1,870 x 580 x 920 - 1,040 mm
Net weight	25.6-28.1 kg (56.4-61.9 lbs.)



Blade, Mulch Plug, Socket Wrench, Rod, Battery, Charger, Z: Battery and Charger are sold separately

DLM533Z 534mm (21") Cordless Lawn Mower

18V X2 (36V) LXT BL Cordless 53 cm (21") Self-Propelled Lawn Mower



Li-ion Ah 6.0 5.0 3.0 1.5

Cutting Width	534 mm (21")
Cutting Height	20-100 mm (13/16"-3-15/16")
No Load Speed (RPM)	2,300-2,800
Dimensions (L x W x H)	1,655-1,740 x 590 x 990-1,100 mm (65"-68-1/2" x 23-1/4" x 39"-43-1/4")
Net weight	42.8-46.7 kg (94.4-103 lbs.)



Blade, Mulch plug, Socket Wrench, Rod, Battery, Charger, Z: Battery and Charger are sold separately

DLM532Z / DLM530Z 534mm (21") Cordless Lawn Mower

18V X2 LXT BL Brushless Cordless Self-Propelled Lawn Mower (DLM532 only)



Li-ion Ah 6.0 5.0 3.0 1.5

Cutting Width	534 mm (21")
Cutting Height	20-100 mm (13/16"-3-15/16")
No Load Speed (RPM)	2,300-2,800
Dimensions (L x W x H)	1,630-1,715 x 590 x 990-1,190 mm (64"-67-1/2" x 23-1/4" x 39"-46-3/4")
Net weight	DLM530Z: 35.5-39.3 kg (78.3-86.6 lbs.) DLM532Z: 39.0-42.8 kg (86.0-94.4 lbs.)



Blade, Mulch plug, Side Discharge Mouth, Socket Wrench, Rod, Battery, Charger, Z: Battery and Charger are sold separately

DLM481Z 480mm (18-7/8") Cordless Lawn Mower

18V X2 (36V) BL Brushless Cordless 48 cm (18-7/8") Lawn Mower



Li-ion Ah 6.0 5.0 3.0 1.5

Cutting Width	480 mm (18-7/8")
Cutting Height	20-100 mm (13/16"-3-15/16")
No Load Speed (RPM)	3,100
Propelling Speed	2.5-5.0 km/h
Actual Mowing Area	w/ BL1860B x2, Self-Propelled: 650 m ²
	w/ BL1860B x2, Push-Drive: 800 m ²
Continuous Use (min.)	w/ BL1860B x2, Self-Propelled: 23
	w/ BL1860B x2, Push-Drive: 28
Dimensions (L x W x H)	During Operation: 1,690-1,740 x 530 x 930 - 1,060 mm
Net weight	27.1-29.3 kg



Blade, Mulch Plug, Socket Wrench, Rod, Battery, Charger, Z: Battery and Charger are sold separately

DLM480Z 480mm (18-7/8") Cordless Lawn Mower

18V X2 (36V) BL Brushless Cordless 48 cm (18-7/8") Lawn Mower



Li-ion Ah 6.0 5.0 3.0 1.5

Cutting Width	480 mm (18-7/8")
Cutting Height	20-100 mm (13/16"-3-15/16")
No Load Speed (RPM)	3,100
Actual Mowing Area	w/ BL1860B x2, Push-Drive: 800 m ²
Continuous Use (min.)	w/ BL1860B x2, Push-Drive: 28
Dimensions (L x W x H)	During Operation: 1,690-1,740 x 530 x 930 - 1,060 mm
Net weight	24.5-26.8 kg (54.0-59.1 lbs.)



Blade, Mulch Plug, Socket Wrench, Rod, Battery, Charger, Z: Battery and Charger are sold separately

DLM462Z 460mm (18") Cordless Lawn Mower

18V X2 LXT BL Brushless Cordless 46 cm (18") Self-Propelled Lawn Mower



Li-ion Ah 6.0 5.0 3.0 1.5

Cutting Width	460 mm (18")
Cutting Height	20-100 mm (13/16"-3-15/16")
No Load Speed (RPM)	2,500-3,300
Propelling speed	2.5-5.0 km/h
Dimensions (L x W x H)	1,610-1,690 x 535 x 980-1,095 mm (63-1/2"-66-1/2" x 21"x38-1/2"-43")
Net weight	35.3-39.0 kg (77.8-86.0 lbs.)



Blade, Mulch plug, Socket Wrench, Rod, Battery, Charger, Z: Battery and Charger are sold separately

DLM460Z 460mm (18") Cordless Lawn Mower

Brushless Cordless 46 cm (18") 3-in-1 Mower

Li-ion Ah 6.0 | 5.0 | 3.0 | 1.5



Blade Type	2 Tooth
Hole Diameter	10.0 mm (3/8")
Cutting Width	460 mm (18")
Cutting Height	20-75mm (13/16"-2-5/16")
No Load Speed (RPM)	2,500 - 3,300
Recommended mowing area	w/ BL1860B x2: 800 - 1,600 m ²
Continuous Use (min.)	w/ BL1860B / BL1850B / BL1840B / BL1830B / BL1820B / BL1815N21 / 18/14/10/8/6
Sound Power Level	91 dB(A)
Dimensions (L x W x H)	1,319-1,518x532x
Net weight	879-1,138 mm 253-276 kg (55.8-60.8 lbs.)

18V x2



Blade, Socket Wrench, Battery, Fast Charger, Z: Battery and Charger are sold separately



DLM382CF2 / Z 380mm (15") Cordless Lawn Mower

2-in-1 Mower

Li-ion Ah 6.0 | 5.0 | 3.0 | 1.5



DLM382CF2

DC18SH: Two Part Multi Slow Charge

Cutting Width	380 mm (15")
Cutting Height	20 - 75 mm (13/16" - 2-15/16")
No Load Speed (RPM)	3,700
Dimensions (L x W x H)	1,380-1,410x450x 985-1,005 mm (54-1/4"-55-1/2"x17- 3/4"x38-3/4"-39-1/2")
Net weight	16.2 - 16.9 kg (35.7 - 37.3 lbs.)

18V x2



Blade, Wrench, Battery, Charger, Z: Battery and Charger are sold separately

DLM330RG 330mm (13") Cordless Lawn Mower

18V LXT Li-Ion Cordless 330 mm (13") 3 in 1 Lawn Mower

Li-ion Ah 6.0 | 5.0 | 3.0 | 1.5



Cutting Width	330 mm (13")
Cutting Height	20 - 75 mm (13/16" - 2-15/16")
Grass Box Capacity	30 L
No Load Speed (RPM)	4,300
Actual Mowing Area	w/ BL1840B: 270 m ²
Continuous Use (min.)	w/ BL1840B: 14
Wheel Size	Front / Rear: 140 / 180 mm (5-1/2" / 7-1/8")
Dimensions (L x W x H)	During Operation: 1,285 - 1,350 x 375 x 935 - 975 mm, When Stored (w/o Grass Box): 520 x 375 x 775 mm
Net weight	11.6 - 12.5 kg

18V



Blade, Mulching Plug, Wrench, Battery, Charger, Z: Battery and Charger are sold separately

DLM230RG / Z 230mm (9") Cordless Lawn Mower

18V LXT Cordless 23 cm (9") 2-in-1 Lawn Mower

Li-ion 6.0 | 5.0 | 3.0 | 1.5



Cutting Width	230 mm (9")
Cutting Height	10 - 55 mm
Grass Box Capacity	20 L
No Load Speed (RPM)	7,000
Actual Mowing Area	w/ BL1830B: 90 m ²
Continuous Use (min.)	w/ BL1830B: 6 min
Wheel Diameter	130 / 55 mm
Dimensions (L x W x H)	During Operation: 860 - 1,105 x 256 x 680 - 920 mm, When Stored (w/o Grass Box): 264 x 363 x 780 mm
Net weight	8.6 - 8.9 kg

18V



Blade, Hex wrench, Rod, Battery, Charger, Z: Battery and Charger are sold separately

ELM4620 460mm (18-1/8") Electric Lawn Mower

1,800N 4-in-1 Electric Mower



Continuous rating input	1,800W
Cutting Width	460 mm (18-1/8")
Cutting Height	20-75mm (13/16"-2-15/16")
No Load Speed (RPM)	2,950
Recommended mowing area up to	800 m ²

1

Blade, Wrench, Mulch Plug

ELM4121 410mm (16-1/8") Electric Lawn Mower

Stays upright for easy maintenance and cleaning



Continuous rating input	1,600W
Cutting Width	410 mm (16-1/8")
Cutting Height	20-75mm (13/16"-2-15/16")
No Load Speed (RPM)	3,400
Recommended mowing area up to	600 m ²

1

Blade, Wrench, Mulch Plug, Side Discharge Mouth

ELM3720 370mm (14-1/2") Electric Lawn Mower

Stays upright for easy maintenance and cleaning



Continuous rating input	1,400W
Cutting Width	370 mm (14-1/2")
Cutting Height	20-55mm (13/16"-2-3/16")
No Load Speed (RPM)	3,400
Recommended mowing area up to	500 m ²

1

Blade, Wrench

ELM3320 330mm (13") Electric Lawn Mower

Stays upright for easy maintenance and cleaning



Continuous rating input	1,200W
Cutting Width	330 mm (13")
Cutting Height	20-55mm(13/16"-23/16")
No Load Speed (RPM)	3,400
Recommended mowing area up to	400 m ²



Blade, Wrench

UV001GZ Cordless Scarifier

New

40Vmax XGT BL Cordless 380mm (15") Scarifier

Li-ion Ah 8.0 | 5.0 | 4.0 | 2.5 | 2.0



Cutting width	380 mm (15")
Working depth	-12 mm (-15/32") to 5 mm (+3/16")
Continuous run time on full battery charge	w/ BL4080F x2, Vertical cutter: 38 min Thatching blade: 41 min
Actual mowing area on full battery charge	w/ BL4080F x2, Vertical cutter: 500 m ² Thatching blade: 510 m ²
No load speed (RPM)	3,200
Grass catcher capacity	50 L
Dimensions (L x W x H)	1,020-1,240 x 680 x 915-1,155 mm
Net weight	18.7-23.8 kg (41.2-52.5 lbs.)



Vertical cutter, Thatching blade, Socket wrench, Grass catcher, Battery, Charger, Z: Battery and Charger are sold separately

Healthy Lawn Growth and Maintenance with Aeration & Thatching

Photo: UV001G

Vertical cutter

Aeration applications

Able to perform both thatching and vertical cutting to cut through runners and roots

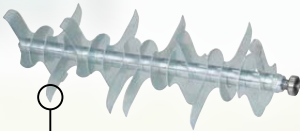

Highly durable vertical cutter

- Blunt angled blade tip slows blade wear to minimize the reduction in working depth.
- The slow wear reduces blade change frequency and running cost.

Low vibration

The blades of Vertical cutter are arranged symmetrically about the left-right center line of the rotary blade shaft to provide balanced rotation for reduced vibration.

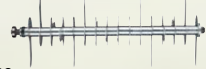

Actual mowing area on full battery charge

With two BL4080F batteries

Vertical cutter Working depth: - 4 mm	Thatching blade Working depth: 0 mm
500 m²	510 m²

Vertical cutting

Effect obtained at different working depth settings

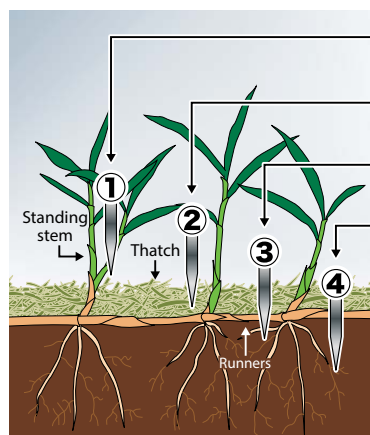

- Cutting through laterally growing lawn grasses for better looking lawn
- Removing layers of lawn clippings, generated moss, etc.
- Cutting through runners and roots for healthy growth of lawn
- Loosening compacted hard surface layer of soil

18 stage (in 1mm increments)

Dial style working depth adjustment
Fine adjustment of working depth can be made by operating a dial, allowing for adjustment of working depth to suit the environment for lawn growth and wear of blade.

Thatching blade

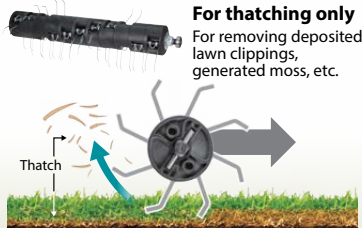

For thatching only
For removing deposited lawn clippings, generated moss, etc.

Easy blade change

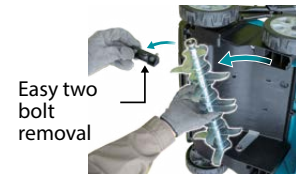

Easy two bolt removal

DUP361ZN

33mm (1-5/16") Cordless Powered Pruning Shears

Smooth cutting similar to that of a hand pruner

Li-ion Ah 6.0 5.0 3.0 1.5



Max Output Capacity 200W
 Max cutting : 33mm
 Max blade opening: 54mm
Dimensions (L x W x H) 305x43x106mm (12"x1-11/16"x4-3/16")
Net weight 0.8 kg (1.8 lbs.)

18V x2

LXI XPT



Oil supply, Wrench set, Diamond file, Cord holder complete (for waist belt), Holster, Harness, Arm band, Tool bag, Shear blade (U), Battery, Fast Charger, Z: Battery and Charger are sold separately

UP100DZ Cordless Pruning Shears

New

Shear blade control is interlocked with Trigger for easier control of the blade

Li-ion Ah 5.0 4.0 2.0 1.5



Capacity Max cutting: 25 mm (1")
Vibration level 2.5 m/s² or less
Sound pressure level 70 dB(A) or less
Dimensions (L x W x H) w/o Battery: 259 x 53 x 98 mm (10-1/4 x 2-1/2 x 3-7/8") w/BL1016/BL1021B: 285 x 64 x 98 mm (11-1/4 x 2-1/2 x 3-7/8") w/BL1041B: 308 x 64 x 98 mm (12-1/8 x 2-1/2 x 3-7/8")
Net weight 0.89 - 1.1 kg (2.0 - 2.4 lbs.)

12Vmax

CX BL MOTOR XPT

Oil spray, Hex wrench, Socket wrench, Dressing stone, Holster, Battery, Charger, DZ: Battery and Charger are sold separately

Max cutting capacity
ø25 mm



Adjustment of blade overlap when closed

(by pressing and holding Blade opening angle adjustment button for 3 seconds or more when fully closed)



Lightweight
0.89 kg
 with BL1016

High cutting performance



with BL1021B

Work amount on a full battery charge

When cutting ø15mm branches of Japanese cypress

about 2,200 pcs



Photo: UP100D



DUS158Z 15L Cordless Garden Sprayer

WetGuard; Excellent water-resistant performance

Li-ion Ah 6.0 5.0 3.0 1.5



Max Pressure 0.5 MPa
Chemical tank 15 L
Hose Length 1.7 m
Continuous Use (min.) Y-shaped double nozzle: W/BL1830B: 120
 Wide angle herbicide nozzle: W/BL1830B: 180
Dimensions (L x W x H) 325 x 237 x 517 mm (12-3/4 x 9-3/8 x 20-3/8")
Net weight 4.6 kg (10.1 lbs.)

18V

LXI XPT

Upright Double-Headed Nozzle, Wide-Angle Herbicide Nozzle, Shoulder Harness, Holder, Measure cup, Battery, Charger, Z: Battery and Charger are sold separately

DUS108Z 10L Cordless Garden Sprayer

WetGuard; Excellent water-resistant performance

Li-ion Ah 6.0 5.0 3.0 1.5



Max Pressure 0.5 MPa
Chemical tank 10 L
Hose Length 1.7 m
Continuous Use (min.) Y-shaped double nozzle: W/BL1830B: 120
 Wide angle herbicide nozzle: W/BL1830B: 180
Dimensions (L x W x H) 325 x 237 x 439 mm (12-3/4 x 9-3/8 x 17-1/4")
Net weight 4.6 kg (10.1 lbs.)

18V

LXI XPT

Upright Double-Headed Nozzle, Wide-Angle Herbicide Nozzle, Shoulder Harness, Holder, Measure cup, Battery, Charger, Z: Battery and Charger are sold separately



DUS054Z 5L Cordless Garden Sprayer

Two head nozzles for a wide range of spray

Li-ion Ah 6.0 5.0 3.0 1.5



Max Pressure 0.3 MPa (3 kgf/cm²)
Chemical tank 5 L
Hose Length 1.7 m
Continuous Use (min.) Spray Single: w/BL1860B: 530 min
Dimensions (L x W x H) 340 x 183 x 360 mm (13-3/8 x 7-1/4 x 14-1/8")
Net weight 2.1 kg (4.6 lbs.)

18V

LXI XPT

Shoulder Harness, Holder, Battery, Charger, Z: Battery and Charger are sold separately

US053DZ 5L Cordless Garden Sprayer

12Vmax CXT Li-Ion Cordless 5 L Garden Sprayer

Li-ion Ah 5.0 | 4.0 | 2.0 | 1.5

Max Pressure	0.3 Mpa (3 kgf/cm ²)
Chemical tank	5 L
Hose Length	1.7 m
Continuous Use (min.)	Spray Single: w/ BL1041B :250
Dimensions (L x W x H)	340 x 183 x 335 mm (13-3/8 x 7-1/4 x 13-1/4")
Net weight	2.0 kg



12Vmax **CXT XPT**

Shoulder Harness, Holder, Battery, Charger, DZ: Battery and Charger are sold separately

DVF154Z 15L Cordless Garden Sprayer

Environmentally-friendly with no emission and extremely low noise

Li-ion Ah 6.0 | 5.0 | 3.0 | 1.5

Max pressure	0.3Mpa (3kgf/cm ²)
Chemical tank	15L
Dimensions (L x W x H)	345x235x525mm (13-5/8"x9-1/4"x20-3/4")
Net weight	4.1 - 4.5kg (9.1 - 9.7lbs)



18V **LXT**

Y-shaped Double Nozzle, Wide Angle Nozzle, Spray Pipe Holder, Shoulder Harness, Z: Battery and Charger are sold separately

DVF104Z 10L Cordless Garden Sprayer

Environmentally-friendly with no emission and extremely low noise

Li-ion Ah 6.0 | 5.0 | 3.0 | 1.5

Max pressure	0.3Mpa (3kgf/cm ²)
Chemical tank	10L
Dimensions (L x W x H)	315x225x415mm (12-3/8"x8-7/8"x16-3/8")
Net weight	3.8 - 4.1kg (8.4 - 9.1lbs)



18V **LXT**

Y-shaped Double Nozzle, Wide Angle Nozzle, Spray Pipe Holder, Shoulder Harness, Z: Battery and Charger are sold separately

PM001GT202(PT2) / GZ01 Cordless Backpack Mist Blower

New

40Vmax XGT BL Cordless Backpack Mist Blower

Li-ion Ah 8.0 | 5.0 | 4.0

Chemical tank capacity	15.0 L (507 oz)
Max air volume	High/Med./Low: 14.3/11.0/9.0 m ³ /min
Max air velocity	High/Med./Low: 64.0/52.0/42.0 m/s
Avg. air velocity	High/Med./Low: 53.0/43.0/34.0 m/s
Vibration level	84.5 dB (A)
Sound power level	103.3 dB (A)
Continuous Use (min.)	w/ BL4080F-x2 High: 20 w/o Nozzle:
Dimensions (L x W x H)	320 x 600 x 690 mm (12-5/8 x 23-5/8 x 27-1/4")
Net weight	13.2 - 15.7 kg (29.1 - 34.6 lbs.)



40Vmax

Diffusion cover, Wrench, Nozzle, Battery, Charger, Z: Battery and Charger are sold separately



Photo: PM001G

Solution tank capacity
15 L

Powered by 40Vmax XGT Li-Ion battery (two in parallel or one)

Average particle size

High spraying speed mode

50/150 μm
ULV nozzle/Standard nozzle

Switch Interlocking Valve

The opening/closing operation of the solution supply valve is interlocked with the switch trigger to suppress dripping of solution.

Max spray distance: 14m



A variety of front covers

Diffusion cover

You can diffuse the mist by attaching the diffusion cover to the end nozzle

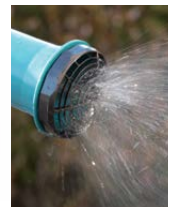

Deflector set (Option)

You can discharge the mist upward or downward by attaching the deflector to the end nozzle

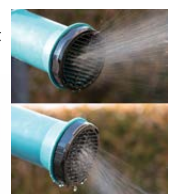

DG001GZ02 Cordless Earth Auger

Lightweight design for reduced operator fatigue

Li-ion Ah 8.0 | 5.0 | 4.0 | 2.5 | 2.0

Capacity	Sandy Soil: 200 mm Clay Soil: 150 mm
No Load Speed (RPM)	High / Low: 0 - 1,500 / 0 - 400
Max Fastening Torque	High: 55 N-m (487 in.lbs.) Low: 136 N-m (1,210 in.lbs.)
Dimensions (L x W x H)	836 x 605 x 199 mm (33 x 23-3/4 x 7-7/8")
Net weight	7.2 - 8.1 kg (15.9 - 17.9 lbs.)



40Vmax



XGT BL ADT XPT

Chuck Key, Hex Wrench, Adapter, Battery, Charger, Z: Battery and Charger are sold separately

DDG460ZX4 Cordless Earth Auger

Battery powered and powerful

Li-ion Ah 6.0 | 5.0 | 3.0 | 1.5

Capacity	Sandy Soil: 200 mm Clay Soil: 150 mm
No Load Speed (RPM)	High / Low: 0 - 1,400 / 0 - 350
Max Fastening Torque	High: 48 N-m (430 in.lbs.) Low: 136 N-m (1,210 in.lbs.)
Vibration Level	2.5 m/s ² or less
Sound Pressure Level	85 dB(A)
Sound Power Level	96 dB(A)
Dimensions (L x W x H)	840 x 607 x 223 mm (33 x 23-7/8 x 8-3/4")
Net weight	7.3 - 8.2 kg (16.1 - 18.1 lbs.)



18V x2



LXT BL ADT XPT

Chuck Key, Hex Wrench, Adapter, Battery, Charger, Z: Battery and Charger are sold separately



CORDLESS TOOLS FOR INDUSTRY



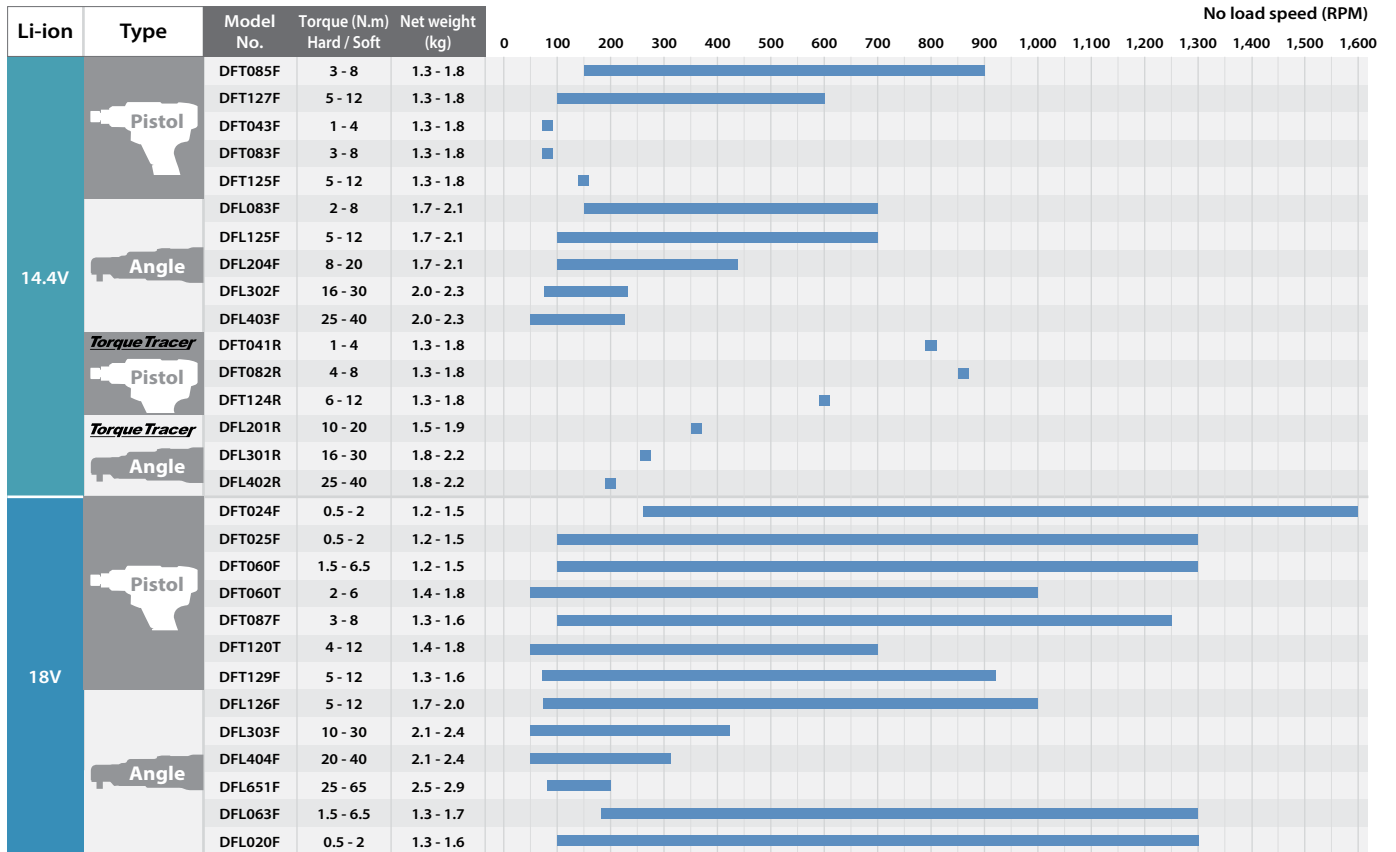



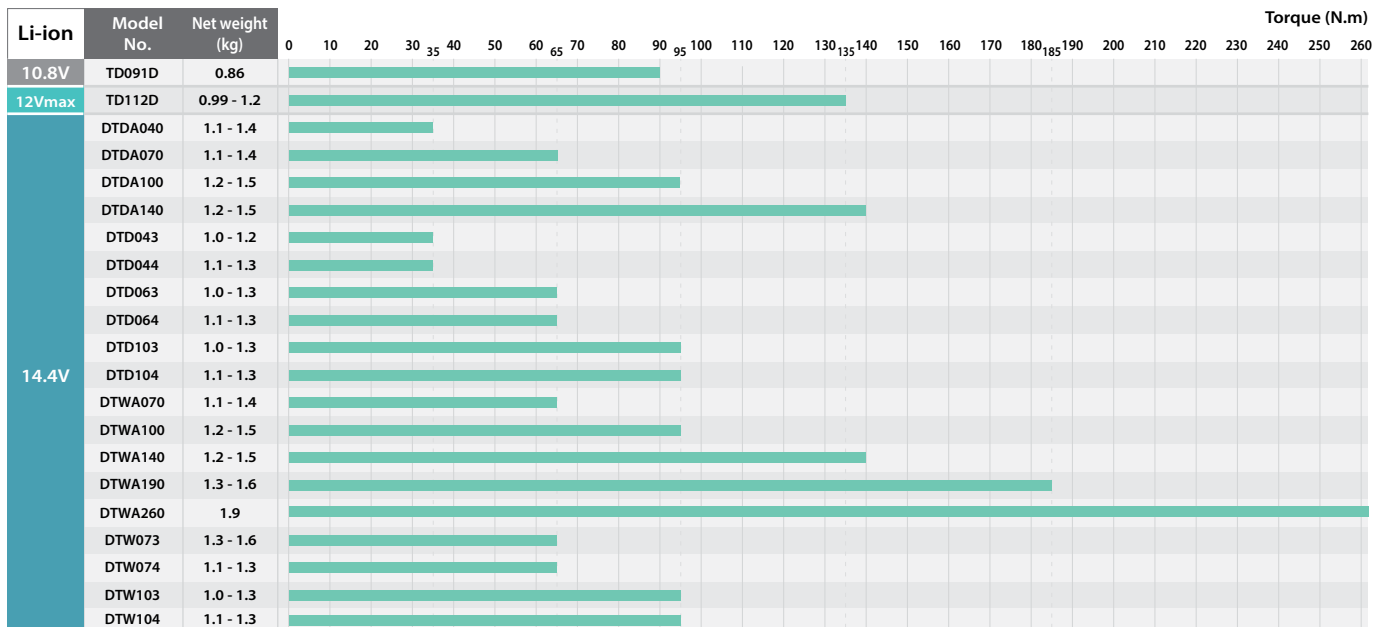



Screwdriver, Angle Screwdriver















Impact Driver, Impact Wrench



Battery & Charger Time Reference Chart (in Minutes)

14.4V Lithium-ion		DC18RC (195586-8)	DC18SD (194534-4)	DC18SE (Automotive) (194621-9)	DC24SC (194164-1)
6.0 Ah	 BL1460A (632G42-4)	 9.6V,12V 14.4V,18V	 9.6V,12V 14.4V,18V	 9.6V,12V 14.4V,18V	 9.6V,12V 14.4V,18V,24V
		 55 min.	130 min.	130 min.	75 min.
4.0 Ah	 BL1440 (196388-5)	36 min.	90 min.	90 min.	-
3.0 Ah	 BL1430A (194359-6)	22 min.	60 min.	60 min.	-
3.0 Ah	 BL1430B (197615-3)	22 min.	60 min.	60 min.	-
1.5 Ah	 BL1415NA (196280-5)	15 min.	30 min.	30 min.	20 min.

MAKSTAR

24V Ni-MH		14.4V Ni-MH		12V Ni-MH		9.6V Ni-MH		DC18RC (195586-8)	DC18SD (194534-4)	DC18SE (Automotive) (194621-9)	DC24WA	DC24SC (194164-1)
3.1 Ah	 BH2433 (193739-3)	 BH1433 (193354-3)	 BH1233C (A-37655)	-	-	-	-	 9.6V,12V 14.4V,18V	 9.6V,12V 14.4V,18V	 9.6V,12V 14.4V,18V	 9.6V,12V,14.4V 18V,24V	 9.6V,12V,14.4V 18V,24V
								22	70	70	70	30
1.8 Ah	 BH2420 (193736-9)	-	 BH1220C (193928-0)	 *BH9020A (193590-1)	 BH9020 (193631-3)			15	40	40	40	20
								BH9033/A : 30min.			BH2433 : 90min.	BH2433 : 60min. DC24SC-BH2433 : 50min.
								BH9020/A : 20min.			BH2420 : 55min.	BH2420 : 30min.

() Part No. * Power Display Type

DFT023FNZ / DFT045FNZ Cordless Screwdriver

14.4V LXT BL Brushless Programmable Cordless 2 N-m (18 In.Lbs.) Screwdriver

Li-ion Ah 6.0 | 5.0 | 3.0 | 1.5



Driving Shank (Hex) 6.35 mm (1/4")
 No Load Speed (RPM) 400 - 1,300 / 150 - 900
 Fastening Torque
 Hard / Soft:
 DFT023FNZ: 0.5 - 2 / 0.5 - 2 N·m (4 - 18 / 4 - 18 in.lbs.)
 DFT045FNZ: 1 - 4 / 1 - 4 N·m (9 - 35 / 9 - 35 in.lbs.)
 Sound Pressure Level 70 dB(A) or less
 Dimensions (L x W x H) 159x72x232 mm (6-1/4"x2-13/16"x9-1/8")
 Net weight 1.1 - 1.3 kg (2.4 - 2.9 lbs.)

14.4V



Adjust Grip (country-specific), USB Cable, Z: Battery and Charger are sold separately

DFT024FNZ Cordless Screwdriver

18V LXT BL Brushless Programmable Cordless Screwdriver

Li-ion Ah 6.0 | 5.0 | 3.0 | 1.5



Driving Shank (Hex) 6.35 mm (1/4")
 No Load Speed (RPM) 260 - 1,600
 Fastening Torque
 Hard / Soft:
 0.5 - 2 / 0.5 - 2 N·m (4 - 18 / 4 - 18 in.lbs.)
 w/ BL1830B / BL1840B / BL1850B / BL1860B:
 161 x 75 x 258 mm (6-3/8 x 2-15/16 x 10-1/8")
 Net weight 1.2 - 1.5 kg (2.6 - 3.3 lbs.)

18V



Torque Adjust Tool (country-specific), USB Cable (country-specific), Z: Battery and Charger are sold separately

DFT025FNZ / DFT060FNZ Cordless Screwdriver

18V LXT BL Brushless Programmable Cordless Screwdriver

Li-ion Ah 6.0 5.0 3.0 1.5



Driving Shank (Hex)	DFT025FNZ: 5 mm (1/4") DFT060FNZ: 6.35 mm (1/4")
No Load Speed (RPM)	100 - 1,300
Fastening Torque	DFT025FNZ: Hard / Soft: 0.5 - 2 / 0.5 - 2 N·m DFT060FNZ: Hard / Soft: 1.5 - 6.5 / 1.5 - 6.5 N·m
Dimensions (L x W x H)	w/ BL1830B / BL1840B / BL1850B / BL1860B: 161 x 75 x 258 mm (6-3/8 x 2-15/16 x 10-1/8")
Net weight	1.2 - 1.5 kg (2.6 - 3.3 lbs.)

18V

Torque Adjust Tool (country-specific), USB Cable (country-specific), Z: Battery and Charger are sold separately

DFT060TNZ / DFT120TNZ Cordless Screwdriver

18V LXT BL Brushless Programmable Cordless Screwdriver

Li-ion Ah 6.0 5.0 3.0 1.5



No Load Speed (RPM)	DFT060TNZ: 50 - 1,400 DFT120TNZ: 50 - 700
Fastening Torque	DFT060TNZ: 2 - 6 N·m DFT120TNZ: 4 - 12 N·m
Dimensions (L x W x H)	w/ BL1830B / BL1840B / BL1850B / BL1860B: 209 x 72 x 249 mm (6-3/8 x 2-15/16 x 10-1/8")
Net weight	1.3 - 1.6 kg

18V

Z: Battery and Charger are sold separately



DFT085FNZ / DFT127FNZ Cordless Screwdriver

14.4V LXT BL Brushless Programmable Cordless Screwdriver

Li-ion Ah 6.0 5.0 3.0 1.5



Driving Shank (Hex)	6.35 mm (1/4")
No Load Speed (RPM)	150 - 900 / 100 - 600
Fastening Torque	Hard / Soft: DFT085FNZ: 3 - 8 / 3 - 8 N·m (27 - 71 / 27 - 71 in.lbs.) DFT127FNZ: 5 - 12 / 5 - 12 N·m (44 - 106 / 44 - 106 in.lbs.)
Sound Pressure Level	70 dB(A) or less
Dimensions (L x W x H)	190x72x237 mm (7-1/2"x2-13/16"x9-3/8")
Net weight	1.3 - 1.8 kg (2.8 - 3.9 lbs.)

14.4V

Adjust Grip (country-specific), USB Cable, Z: Battery and Charger are sold separately

DFT087FNZ / DFT129FNZ Cordless Screwdriver

18V LXT BL Brushless Programmable Cordless Screwdriver

Li-ion Ah 6.0 5.0 3.0 1.5



Driving Shank (Hex)	6.35 mm (1/4")
No Load Speed (RPM)	100 - 1,250 / 70 - 900
Fastening Torque	Hard / Soft: DFT087FNZ: 3 - 8 / 3 - 8 N·m (27 - 71 / 27 - 71 in.lbs.) DFT129FNZ: 5 - 12 / 5 - 12 N·m (44 - 106 / 44 - 106 in.lbs.)
Sound Pressure Level	71 dB(A)
Dimensions (L x W x H)	179 x 75 x 230 mm (7 x 2-15/16 x 9")
Net weight	1.3 - 1.6 kg (2.9 - 3.5 lbs.)

18V

Torque adjust tool (country-specific), USB cable (country-specific), Protector (country-specific), Z: Battery and Charger are sold separately

Li-ion 14.4V Cordless Screw Driver

Auto-stop system and on-off switch with delayed restarter

Prevent defective on production and keep quality



When a battery is discharged, indication lamp and beeper start warning and then the motor stops automatically

The tool remains still for 1 second after fastening is completed.

Indication Lamp & Beeper

Warn and prevent errors on production.



High Power Motor

• Equipped with high power motor
• Easy to change an armature and carbon brush for high maintenance performance

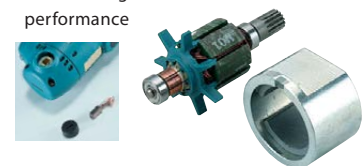

- Rigid Body
- Optimum Charging System
- Ergonomic Grip
- High accuracy
- LED job light
- ON-OFF Switch with delayed restarter and soft start function
- Torque indication plate



DFL020FZ / DFL063FZ Cordless Angle Screwdriver

18V LXT BL Brushless Cordless Angle Screwdriver

Li-ion Ah 6.0 | 5.0 | 3.0 | 1.5



Driving Shank (Square)	9.5 mm (3/8")
No Load Speed (RPM)	DFL020FZ: 100 - 1,300 DFL063FZ: 180 - 1,300
Fastening Torque	Hard / Soft: DFL020FZ: 0.5 - 2 / 0.5 - 2 N·m (4 - 18 / 4 - 18 in.lbs.), DFL063FZ: 1.5 - 6.5 / 1.5 - 6.5 N·m (13 - 58 / 13 - 58 in.lbs.)
Dimensions (L x W x H)	397x74x116 mm (15-5/8"x2-5/16"x4-9/16")
Net weight	1.3 - 1.6 kg (2.9 - 3.6 lbs.)

18V



Adjust Grip (country-specific), USB Cable, Z: Battery and Charger are sold separately

DFL302FZ Cordless Angle Screwdriver

14.4V LXT BL Brushless Cordless Angle Screwdriver

Li-ion Ah 6.0 | 5.0 | 3.0 | 1.5



Driving Shank (Square)	9.5 mm (3/8")
No Load Speed (RPM)	70 - 230 / 50 - 220
Fastening Torque	Hard / Soft: 16 - 30 / 16 - 30 N·m (142 - 266 / 142 - 266 in.lbs.)
Dimensions (L x W x H)	518x74x98 mm (20-3/8"x2-15/16"x3-7/8")
Head Height	35 mm (1-3/8")
Center Height	18.5 mm (3/4")
Net weight	2.0 - 2.3 kg (4.4 - 5.2 lbs.)

14.4V



Adjust Grip (country-specific), Protector (country-specific), USB Cable, Z: Battery and Charger are sold separately

DFL402FZ Cordless Angle Screwdriver

14.4V LXT BL Brushless Cordless Angle Screwdriver

Li-ion Ah 6.0 | 5.0 | 3.0 | 1.5



Driving Shank (Square)	9.5 mm (3/8")
No Load Speed (RPM)	260 / 200
Fastening Torque	Hard / Soft: 25 - 40 / 25 - 40 N·m (221 - 354 / 221 - 354 in.lbs.)
Sound Pressure Level	74 dB(A) / 72 dB(A)
Dimensions (L x W x H)	477x72x98 mm (18-3/4"x2-13/16"x3-7/8")
Net weight	1.7 - 2.1 kg (3.8 - 4.6 lbs.)

14.4V



Z: Battery and Charger are sold separately

DFL083FZ Cordless Angle Screwdriver

14.4V LXT BL Brushless Cordless Angle Screwdriver

Li-ion Ah 6.0 | 5.0 | 3.0 | 1.5



Driving Shank (Square)	9.5 mm (3/8")
No Load Speed (RPM)	150 - 700 / 100 - 700 / 100 - 440
Fastening Torque	Hard / Soft: 2 - 8 / 2 - 8 N·m
Dimensions (L x W x H)	481x74x98 mm (19"x2-15/16"x3-7/8")
Head Height	31.5 mm (1-1/4")
Center Height	16 mm (5/8")
Net weight	1.7 - 2.1 kg (3.8 - 4.7 lbs.)

14.4V



Adjust Grip (country-specific), Protector (country-specific), USB Cable, Z: Battery and Charger are sold separately

Touch&Set

Easy to set by smart device

4 stage programmable speed can be set by touching with NFC (Near Field Communication) function of Android.

Near Field Communication
NFC

Photo: DFL650F

DFL650FZ Cordless Angle Screwdriver

18V LXT BL Brushless Cordless 65 N-m (580 in.lbs.) Angle Screwdriver

Li-ion Ah 6.0 | 5.0 | 3.0 | 1.5



Driving Shank (Square)	9.5 / 12.7 mm (3/8" / 1/2")
No Load Speed (RPM)	80 - 200
Fastening Torque	Hard / Soft: 25 - 65 / 25 - 65 N-m (220 - 580 / 220 - 580 in.lbs.)
Vibration Level	Screwdriving without Impact: 2.5 m/s ² or less
Sound Pressure Level	72 dB(A)
Dimensions	600x75x116 mm
(L x W x H)	(23-5/8"x2-15/16"x4-9/16")
Net weight	2.4 - 2.9 kg (5.3 - 6.3 lbs)

18V



Torque Adjustment Tool, USB Cable, Z: Battery and Charger are sold separately

DTDA040Z Cordless Impact Driver

14.4V LXT BL Brushless Cordless 35 N-m (310 in.lbs.) Impact Driver

Li-ion Ah 6.0 | 5.0 | 3.0 | 1.5



Capacity	Standard Bolt: M5 - M10 (3/16" - 3/8") High Strength Bolt: M5 - M8 (3/16" - 5/16")
No Load Speed (RPM)	0 - 2,400
Impacts Per Minute (IPM)	0 - 3,700
Max Fastening Torque	35 N-m (310 in.lbs.)
Dimensions	139x74x256 mm
(L x W x H)	(5-1/2"x2-15/16"x10-1/8")
Net weight	1.1 - 1.4 kg (2.4 - 3.1 lbs)

14.4V



4

Z: Battery and Charger are sold separately

DTDA070Z Cordless Impact Driver

14.4V LXT BL Brushless Cordless 65 N-m (575 in.lbs.) Impact Driver

Li-ion Ah 6.0 | 5.0 | 3.0 | 1.5



Capacity	Standard Bolt: M5 - M12 (3/16" - 1/2") High Strength Bolt: M5 - M10 (3/16" - 3/8")
No Load Speed (RPM)	0 - 2,500
Impacts Per Minute (IPM)	0 - 3,700
Max Fastening Torque	65 N-m (575 in.lbs.)
Dimensions	139x74x256 mm
(L x W x H)	(5-1/2"x2-15/16"x10-1/8")
Net weight	1.1 - 1.4 kg (2.4 - 3.1 lbs.)

14.4V



4

Z: Battery and Charger are sold separately

DTDA140Z Cordless Impact Driver

14.4V LXT BL Brushless Cordless 140 N-m (1,240 in.lbs.) Impact Driver

Li-ion Ah 6.0 | 5.0 | 3.0 | 1.5



Capacity	Standard Bolt: M6 - M16 (1/4" - 5/8") High Strength Bolt: M6 - M12 (1/4" - 1/2")
No Load Speed (RPM)	0 - 2,700
Impacts Per Minute (IPM)	0 - 3,300
Max Fastening Torque	140 N-m (1,240 in.lbs.)
Dimensions	146x74x256 mm
(L x W x H)	(5-3/4"x2-15/16"x10-1/8")
Net weight	1.2 - 1.5 kg (2.7 - 3.3 lbs.)

14.4V



4

Z: Battery and Charger are sold separately

TD043DNZ Cordless Impact Driver

14.4V LXT Li-Ion Cordless Impact Driver

448

Li-ion Ah 3.0 | 1.5



Capacity	Machine Screw: M4 - M8 (5/32" - 5/16") Standard Bolt: M5 - M10 (3/16" - 3/8") High Strength Bolt: M5 - M6 (3/16" - 1/4")
No Load Speed (RPM)	0-2,300
Impacts Per Minute (IPM)	0-3,500
Max Fastening Torque	35 N-m (310 in.lbs.)
Dimensions	144x74x216 mm
(L x W x H)	(5-5/8"x2-15/16"x8-1/2")
Net weight	1 - 1.2 kg (2.2 - 2.7 lbs.)

14.4V



Compatible with only batteries with battery fuel gauge.

Z: Battery and Charger are sold separately



TD063DNZ Cordless Impact Driver

14.4V LXT Li-Ion Cordless Impact Driver

448

Li-ion Ah 3.0 | 1.5



Capacity	Machine Screw: M4 - M8 (5/32" - 5/16") Standard Bolt: M5 - M12 (3/16" - 1/2") High Strength Bolt: M5 - M10 (3/16" - 3/8")
No Load Speed (RPM)	0-2,500
Impacts Per Minute (IPM)	0-3,500
Max Fastening Torque	65 N-m (575 in.lbs.)
Dimensions	144x74x216 mm
(L x W x H)	(5-5/8"x2-15/16"x8-1/2")
Net weight	1 - 1.3 kg (2.3 - 2.8 lbs.)

14.4V



Compatible with only batteries with battery fuel gauge.

Z: Battery and Charger are sold separately

DTWA070Z 9.5mm (3/8") Cordless Impact Wrench

14.4V LXT BL Brushless Cordless 3/8" (9.5 mm) 65 N-m (48 ft.lbs.) Impact Wrench

Li-ion Ah 6.0 | 5.0 | 3.0 | 1.5



Square Drive Capacity	9.5 mm (3/8") Standard Bolt: M5 - M12 (3/16" - 1/2") High Strength Bolt: M5 - M10 (3/16" - 3/8")
No Load Speed (RPM)	0 - 2,500
Impacts Per Minute (IPM)	0 - 3,700
Max Fastening Torque	65 N-m (48 ft.lbs.)
Dimensions	144x74x256 mm
(L x W x H)	(5-5/8"x2-15/16"x10-1/8")
Net weight	1.1 - 1.4 kg (2.4 - 3.1 lbs.)

14.4V



4

Z: Battery and Charger are sold separately

DTWA100Z 9.5mm (3/8") Cordless Impact Wrench

14.4V LXT BL Brushless Cordless 3/8" (9.5 mm) 95 N-m (70 ft.lbs.) Impact Wrench

Li-ion Ah 6.0 | 5.0 | 3.0 | 1.5



Square Drive Capacity	9.5 mm (3/8") Standard Bolt: M5 - M12 (3/16" - 1/2") High Strength Bolt: M5 - M10 (3/16" - 3/8")
No Load Speed (RPM)	0 - 2,700
Impacts Per Minute (IPM)	0 - 3,300
Max Fastening Torque	95 N-m (70 ft.lbs.)
Dimensions (L x W x H)	158x74x256 mm
Net weight	1.2 - 1.5 kg (2.7 - 3.3 lbs.)

14.4V



Z: Battery and Charger are sold separately

DTWA140Z 12.7mm (1/2") Cordless Impact Wrench

14.4V LXT BL Brushless Cordless 12.7 mm (1/2") 140 N-m (103 ft.lbs.) Impact Wrench

Li-ion Ah 6.0 | 5.0 | 3.0 | 1.5



Square Drive Capacity	12.7 mm (1/2") Standard Bolt: M6 - M16 (1/4" - 5/8") High Strength Bolt: M6 - M12 (1/4" - 1/2")
No Load Speed (RPM)	0 - 2,700
Impacts Per Minute (IPM)	0 - 3,300
Max Fastening Torque	140 N-m (103 ft.lbs.)
Dimensions (L x W x H)	158x74x256 mm
Net weight	1.2 - 1.5 kg (2.7 - 3.3 lbs.)

14.4V



Z: Battery and Charger are sold separately

DTWA190Z 12.7mm (1/2") Cordless Impact Wrench

14.4V LXT BL Brushless Cordless 12.7 mm (1/2") 185 N-m (136 ft.lbs.) Impact Wrench

Li-ion Ah 6.0 | 5.0 | 3.0 | 1.5



Square Drive Capacity	12.7 mm (1/2") Standard Bolt: M8 - M16 (5/16" - 5/8") High Strength Bolt: M8 - M14 (5/16" - 9/16")
No Load Speed (RPM)	0 - 2,600
Impacts Per Minute (IPM)	0 - 3,000
Max Fastening Torque	185 N-m (136 ft.lbs.)
Dimensions (L x W x H)	158x74x256 mm
Net weight	1.3 - 1.6 kg (2.9 - 3.5 lbs.)

14.4V



Z: Battery and Charger are sold separately

DTWA260Z 12.7mm (1/2") Cordless Impact Wrench

New

18V LXT BL Brushless Cordless 12.7 mm (1/2") 260 N-m Impact Wrench

Li-ion Ah 6.0 | 5.0 | 3.0 | 1.5



Square Drive Capacity	12.7 mm (1/2") Standard Bolt: M14 - M20 (9/16" - 3/4") High Strength Bolt: M10 - M16 (3/8" - 5/8")
No Load Speed (RPM)	0 - 2,800
Impacts Per Minute (IPM)	0 - 3,400
Max Fastening Torque	260 N-m (190 ft.lbs.)
Dimensions (L x W x H)	161 x 82 x 265 mm
Net weight	1.8 kg (4.0 lbs.)

18V



Z: Battery and Charger are sold separately

Makita
mt

PRODUCTS



M6500B 6.5mm (1/4") High Speed Drill

Compact and lightweight for reduced operator fatigue

64



Continuous Rating Input Capacity	230W Steel: 6.5 mm (1/4") Wood: 9 mm (11/32")
No Load Speed (RPM)	0 - 4,500
Sound Pressure Level	72 dB(A)
Dimensions (L x W x H)	200x63x164 mm
Net Weight	(7-7/8"x2-1/2"x6-1/2") 0.92 kg (2.0 lbs)
Power Supply Cord	2.0 m (6.6 ft.)



Chuck Key, Chuck Key Holder, Depth Gauge, Cap

M6001B 10mm (3/8") Drill

Compact and lightweight for reduced operator fatigue

85



Continuous Rating Input Capacity	450W Steel: 10 mm (3/8") Wood: 25 mm (1")
No Load Speed (RPM)	0 - 3,000
Sound Pressure Level	77 dB(A)
Dimensions (L x W x H)	229x64x175 mm
Net Weight	(9"x2-1/2"x6-7/8") 1.3 kg (2.9 lbs)
Power Supply Cord	2.0 m (6.6 ft.)



Chuck key

M0600B 10mm (3/8") Drill

Powerful 350 W motor for continuous operation

64



Continuous Rating Input	350W
Capacity	Steel: 10 mm (3/8") Wood: 20 mm (13/16")
No Load Speed (RPM)	0 - 3,000
Sound Pressure Level	77 dB(A)
Dimensions (L x W x H)	230x66x176 mm (9"x2-5/8"x6-15/16")
Net Weight	1.2 kg (2.6 lbs)
Power Supply Cord	2.0 m (6.6 ft)



Chuck Key, Chuck Key Holder

M6600XB 165mm (6-1/2") Mixer

Powerful 800 W motor for improved mixing performance

303



Continuous Rating Input	800W
Blade Diameter	165 mm (6-1/2")
No Load Speed (RPM)	0 - 700
Sound Pressure Level	85 dB(A)
Sound Power Level	96 dB(A)
Dimensions (L x W x H)	280x86x388 mm (11"x3-3/8"x15-1/4")
Net Weight	2.6 - 2.7 kg (5.7 - 5.9 lbs)
Power Supply Cord	2.0 m (6.6 ft)



Mixing Blade, Shaft, Top Grip, D-Handle, Wrenches

M8103B 13mm (1/2") Hammer Drill

High performance and durability at less expense

85



Continuous Rating Input	430W
Capacity	Concrete: 13 mm (1/2") Steel: 13 mm (1/2") Wood: 18 mm (11/16")
Blows Per Minute (BPM)	0 - 33,000
No Load Speed (RPM)	0 - 3,000
Sound Pressure Level	90 dB(A)
Sound Power Level	101 dB(A)
Dimensions (L x W x H)	255x72x193 mm (10"x2-13/16"x7-5/8")
Net Weight	1.8 kg (3.9 lbs)
Power Supply Cord	2.0 m (6.6 ft)



Side Handle, Depth Gauge, Chuck Key, Chuck Key Holder

M8103KX2B 13mm (1/2") Hammer Drill

Ergonomically designed handle with Soft grip

85



Continuous Rating Input	430W
Capacity	Concrete: 13 mm (1/2") Steel: 13 mm (1/2") Wood: 18 mm (11/16")
Blows Per Minute (BPM)	0 - 33,000
No Load Speed (RPM)	0 - 3,000
Sound Pressure Level	90 dB(A)
Sound Power Level	101 dB(A)
Dimensions (L x W x H)	255x72x193 mm (10"x2-13/16"x7-5/8")
Net Weight	1.8 kg (3.9 lbs)
Power Supply Cord	2.0 m (6.6 ft)



Side Handle, Depth Gauge, Chuck Key, Chuck Key Holder

M0801B / M0801BX1 16mm (5/8") Hammer Drill

High performance and durability at less expense

85



Continuous Rating Input	500W
Capacity	Concrete: 16 mm (5/8") Steel: 13 mm (1/2") Wood: 20 mm (13/16")
Blows Per Minute (BPM)	0 - 48,000
No Load Speed (RPM)	0 - 3,200
Sound Pressure Level	94 dB(A)
Sound Power Level	105 dB(A)
Dimensions (L x W x H)	261x69x195 mm (10-1/4"x2-3/4"x7-5/8")
Net Weight	1.7 kg (3.7 lbs)
Power Supply Cord	2.0 m (6.6 ft)



Side Grip, Chuck Key, Chuck Key Holder

M8100B 16mm (5/8") Hammer Drill

High performance and durability at less expense

85



Continuous Rating Input	710W
Capacity	Concrete: 16 mm (5/8") Steel: 13 mm (1/2") Wood: 30 mm (1-3/16")
Blows Per Minute (BPM)	0 - 48,000
No Load Speed (RPM)	0 - 3,200
Sound Pressure Level	98 dB(A)
Sound Power Level	109 dB(A)
Dimensions (L x W x H)	296x77x202 mm (11-5/8"x3"x8")
Net Weight	2.1 kg (4.6 lbs.)
Power Supply Cord	2.0 m (6.6 ft)



Chuck Key, Side Grip, Depth Gauge

M8700B 22mm (7/8") Rotary Hammer

Adapted for SDS-PLUS bits

459



Continuous Rating Input	710W
Capacity	Concrete: 22 mm (7/8") Core Bit: 54 mm (2-1/8") Diamond Core Bit (Dry Type): 65 mm (2-9/16") Steel: 13 mm (1/2") Wood: 32 mm (1-1/4")
Blows Per Minute (BPM)	0 - 4,350
No Load Speed (RPM)	0 - 1,100
Dimensions (L x W x H)	362x71x194mm (14-1/4"x2-13/16"x7-5/8")
Net Weight	2.5 - 2.9 kg (5.6 - 6.4 lbs)
Power Supply Cord	2.5 m (8.2 ft)

Tool does not come with bit



Depth gauge, Side grip

M8701B 26mm (1") Combination Hammer

Adapted for SDS-PLUS bits, 3 operation modes

459



Continuous Rating Input	800W
Capacity	Concrete: 26 mm (1") Core Bit: 68 mm (2-11/16") Diamond Core Bit (Dry Type): 80 mm (3-1/8") Steel: 13 mm (1/2") Wood: 32 mm (1-1/4")
Blows Per Minute (BPM)	0 - 4,500
No Load Speed (RPM)	0 - 1,200
Dimensions (L x W x H)	362x71x194mm (14-1/4"x2-13/16"x7-5/8")
Net Weight	2.7 - 3.1 kg (6.0 - 6.8 lbs)
Power Supply Cord	2.5 m (8.2 ft)

Tool does not come with bit



Side grip, Depth gauge

M8600B 17mm (11/16") Demolition Hammer

Satisfactory chipping performance

105



Continuous Rating Input	900W
Impact Energy	7.2 J
Blows Per Minute (BPM)	2,900
Sound Pressure Level	95 dB(A)
Sound Power Level	106 dB(A)
Dimensions (L x W x H)	406x99x232 mm (16"x3-7/8"x9-1/8")
Net Weight	5.4 kg (12 lbs)
Power Supply Cord	4.0 m (13.1 ft)



Bull Point, Side Grip, Bit Grease, Cleaning cloth

M4100B 110mm (4-3/8") Cutter

Redesigned base with grooved back surface for smoother operation

303



Continuous Rating Input	1,200W
Blade Diameter	110 mm (4-3/8")
Max Cutting Capacity	90°: 32 mm (1-1/4")
No Load Speed (RPM)	13,000
Sound Power Level	111 dB(A)
Dimensions (L x W x H)	227x209x166 mm (8-15/16"x8-1/4"x6-1/2")
Net Weight	2.9 kg (6.4 lbs)
Power Supply Cord	2.0 m (6.6 ft.)



Wrench, Water supply fixture, Vinyl tube, Tube holder

M2401B 355mm (14") Portable Cut-off

Powerful cutting with high power motor

203



Continuous Rating Input	2,000W
Wheel Diameter	355 mm (14")
No Load Speed (RPM)	3,800
Sound Pressure Level	100 dB(A)
Sound Power Level	111 dB(A)
Dimensions (L x W x H)	500x280x620 mm (19-3/4"x11"x24-3/8")
Net Weight	13.7 kg (30.2 lbs.)
Power Supply Cord	2.5 m (8.2 ft.)



Abrasive cut-off wheel, Socket wrench



M0900B 100mm (4") Angle Grinder

Two action safety switch for minimizing sudden accidental lock-on

459



Continuous Rating Input	540W
Wheel Diameter	100 mm (4")
No Load Speed (RPM)	12,000
Dimensions (L x W x H)	251x118x97 mm (9-7/8"x4-5/8"x3-13/16")
Net Weight	1.6 kg (3.5 lbs)
Power Supply Cord	2.0 m (6.6 ft)

Tool does not come with depressed center wheel



Lock nut wrench

M9506B 100mm (4") Angle Grinder

720W series

459



Continuous Rating Input	720W
Wheel Diameter	100 mm (4")
No Load Speed (RPM)	11,000
Sound Pressure Level	86 dB(A)
Sound Power Level	97 dB(A)
Dimensions (L x W x H)	261x118x101 mm (10-1/4"x4-5/8"x4")
Net Weight	1.6 kg (3.5 lbs)
Power Supply Cord	2.0 m (6.6 ft)



Side Grip, Lock Nut Wrench

M9509B 100mm (4") Angle Grinder

High performance and durability at less expense

325



Continuous Rating Input	850W
Wheel Diameter	100 mm (4")
No Load Speed (RPM)	11,000
Sound Pressure Level	87 dB(A)
Sound Power Level	98 dB(A)
Dimensions (L x W x H)	276x118x101 mm (10-7/8"x4-5/8"x4")
Net Weight	1.8 kg (3.9 lbs)
Power Supply Cord	2.0 m (6.6 ft.)



Side Grip, Lock Nut Wrench

M9512B 100mm (4") Angle Grinder

High performance and durability at less expense

459



Continuous Rating Input	720W
Wheel Diameter	100 mm (4")
No Load Speed (RPM)	11,000
Dimensions (L x W x H)	258x118x101 mm (10-1/8"x4-5/8"x4")
Net Weight	1.6 kg (3.5 lbs.)
Power Supply Cord	2.0 m (6.6 ft.)



Lock nut wrench

M0910B 100mm (4") Angle Grinder

Design for light duty applications

459



Continuous Rating Input	540W
Wheel Diameter	100 mm (4")
No Load Speed (RPM)	12,000
Dimensions (L x W x H)	251x118x93 mm (9-7/8"x4-5/8"x3-5/8")
Net Weight	1.6 kg (3.4 lbs)
Power Supply Cord	2.0 m (6.6 ft)

Tool does not come with depressed center wheel



Lock nut wrench

M9513B 100mm (4") Angle Grinder

High performance and durability at less expense

325



Continuous Rating Input	850W
Wheel Diameter	100 mm (4")
No Load Speed (RPM)	11,000
Dimensions (L x W x H)	273x118x101 mm (10-3/4"x4-5/8"x4")
Net Weight	1.8 kg (4.0 lbs.)
Power Supply Cord	2.0 m (6.6 ft.)



Lock nut wrench

M9510B 115mm (4-1/2") Angle Grinder

High performance and durability at less expense

325



Continuous Rating Input	850W
Wheel Diameter	115 mm (4-1/2")
No Load Speed (RPM)	11,000
Sound Pressure Level	88 dB(A)
Sound Power Level	99 dB(A)
Dimensions (L x W x H)	276x130x111 mm (10-7/8"x5-1/8"x4-3/8")
Net Weight	2.0 kg (4.5 lbs)
Power Supply Cord	2.0 m (6.6 ft.)



Lock nut wrench

M9508B 125mm (5") Angle Grinder

Machined bevel gears provide longer service life

459



Continuous Rating Input	720W
Wheel Diameter	125 mm (5")
No Load Speed (RPM)	11,000
Sound Pressure Level	88 dB(A)
Sound Power Level	99 dB(A)
Dimensions (L x W x H)	261x140x111 mm (10-1/4"x5-1/2"x4-3/8")
Net Weight	1.9 kg (4.1 lbs)
Power Supply Cord	2.0 m (6.6 ft.)



Side Grip, Lock Nut Wrench

M0920B 180mm (7") Angle Grinder

Heavy-duty motor

203



Continuous Rating Input	2,200W
Wheel Diameter	180 mm (7")
No Load Speed (RPM)	8,500
Sound Pressure Level	91 dB(A)
Sound Power Level	102 dB(A)
Dimension (L x W x H)	439x200x141 mm (17-1/4"x9-7/8"x5-9/16")
Net Weight	5.0 kg (11.0 lbs)
Power Supply Cord	2.0 m (6.6 ft)

Tool does not come with depressed center wheel



Lock nut wrench, Side grip

M0921B 230mm (9") Angle Grinder

Heavy-duty motor

203



Continuous Rating Input	2,200W
Wheel Diameter	230 mm (9")
No Load Speed (RPM)	6,600
Sound Pressure Level	91 dB(A)
Sound Power Level	102 dB(A)
Dimension (L x W x H)	439x250x141 mm (17-1/4"x9-7/8"x5-9/16")
Net Weight	5.3 kg (11.6 lbs)
Power Supply Cord	2.0 m (6.6 ft.)

Tool does not come with depressed center wheel



Lock nut wrench, Side grip

M9002B 125mm (5") Angle Grinder

High performance and durability at less expense

303



Continuous Rating Input	1,050W
Wheel Diameter	125 mm (5")
No Load Speed (RPM)	11,000
Sound Pressure Level	91 dB(A)
Sound Power Level	102 dB(A)
Dimension (L x W x H)	361x140x124 mm (14-1/4"x5-1/2"x4-7/8")
Net Weight	2.8 kg (6.1 lbs.)
Power Supply Cord	2.0 m (6.6 ft.)

Tool does not come with depressed center wheel



Depressed center wheel, Lock nut wrench, Side grip



M9100B 6mm (1/4") Die Grinder

Anti-slip ribs on motor housing for higher maneuverability and better control

411



Continuous Rating Input	480W
Capacity	Collet: 6 mm or 1/4"
Max Wheel Diameter	20 mm (13/16")
No Load Speed (RPM)	33,000
Dimensions (L x W x H)	350x75x75 mm (13-3/4"x2-15/16"x2-15/16")
Net Weight	1.4 kg (3.1 lbs)
Power Supply Cord	2.0 m (6.6 ft)

Tool does not come with wheel point



Wrenches 2, Tool does not come with wheel point

M5801B 185mm (7-1/4") Circular Saw

Well-balanced and Lightweight for superior handling and performance **303**



Continuous Rating Input	1,050W
Blade Diameter	185 mm (7-1/4")
Max Cutting Capacity	90°: 66 mm (2-5/8") 45°: 44 mm (1-3/4")
No Load Speed (RPM)	4,900
Dimensions (L x W x H)	284x231x243 mm (11-1/8"x9-1/8"x9-9/16")
Net Weight	3.5 kg (7.7 lbs)
Power Supply Cord	2.0 m (6.6 ft.)



Guide rule, Hex wrench, TCT saw blade

M2300B 255mm (10") Compound Miter Saw

Externally accessible brushes for easy serviceability **JM23000123**



Continuous Rating Input	1,500W
Blade Diameter	255 mm (10")
Miter Angle	45° L / 45° R
Bevel Angle	45° L
Max Cutting Capacity	90° Miter: 75 x 130 mm (2-15/16" x 5-1/8") 45° Miter, L/R: 75 x 90 mm (2-15/16" x 3-9/16")
No Load Speed (RPM)	4,200
Sound Power Level	105 dB(A)
Dimensions (L x W x H)	610x485x15 mm (24"x19-1/8"x20-1/4")
Net Weight	14.7 kg (32.5 lbs)
Power Supply Cord	2.5 m (8.2 ft)



Wrench, Dust Bag (Holders x2), Vise Assembly, Triangular Rule, Set Plate



M4302B Jig Saw

450 W Top Handle Variable Speed Jig Saw **411**



Continuous Rating Input	450W
Max Cutting Capacity	Wood: 55 mm (2-3/16") Steel: 6 mm (1/4")
Length of Stroke	26 mm (1")
Strokes Per Minute (SPM)	0 - 3,100
Sound Power Level	99 dB(A)
Dimensions (L x W x H)	219x85x191 mm (8-5/8"x3-3/8"x7-1/2")
Net Weight	2.5 kg (5.5 lbs.)
Power Supply Cord	2.0 m (6.6 ft.)



Jig Saw Blade, Hex Wrench

M4301B Jig Saw

Light duty model with continuous input 450W **64**



Continuous Rating Input	450W
Max Cutting Capacity	Wood: 65 mm (2-9/16") at 90° Steel: 6 mm (1/4")
Length of Stroke	18 mm (11/16")
Strokes Per Minute (SPM)	0 - 3,100
Sound Pressure Level	82 dB(A)
Sound Power Level	93 dB(A)
Dimensions (L x W x H)	214x75x202 mm (8-3/8"x2-15/16"x8")
Net Weight	1.9 kg (4.1 lbs)
Power Supply Cord	2.0 m (6.6 ft)



Jig Saw Blade Set, Hex Wrench

M4500B Recipro Saw

Screw-down blade clamp **303**



Screw-down blade clamp

Continuous Rating Input	1,010W
Length of Stroke	28 mm (1-1/8")
Strokes Per Minute (SPM)	0 - 2,800
Capacity	Pipe: 130 mm (5-1/8") Wood: 255 mm (10")
Sound Power Level	99 dB(A)
Dimensions (L x W x H)	457x98x174 mm (18"x3-7/8"x6-7/8")
Net Weight	3.1 kg (6.9 lbs)
Power Supply Cord	2.0 m (6.6 ft)



Hex wrench

M3700B 6mm (1/4") Trimmer

Ergonomic slim body design for added comfort and control **411**



Continuous Rating Input	530W
Collet Capacity	6 mm or 1/4"
No Load Speed (RPM)	35,000
Plunge Capacity	0 - 42 mm (0 - 1-5/8")
Sound Power Level	94 dB(A)
Dimension (L x W x H)	82x90x199 mm (3-1/4"x3-1/2"x7-7/8")
Net Weight	1.4 kg (3.1 lbs.)
Power Supply Cord	2.0 m (6.6 ft.)



Trimmer Guide Assembly, Straight Guide Assembly, Template Guide, Straight Bit (Carbidge-Tipped), Wrenches 2

M3601B 8mm (3/8") Router

High performance and durability at less expense **106**



Continuous Rating Input	900W
Collet Capacity	6 mm, 8 mm or 1/4", 3/8"
Plunge Capacity	0 - 35 mm (0 - 1-3/8")
No Load Speed (RPM)	27,000
Sound Pressure Level	91 dB(A)
Sound Power Level	102 dB(A)
Dimensions (L x W x H)	256x110x218 mm (10-1/8"x4-5/16"x8-5/8")
Net Weight	2.7 kg (6.0 lbs)
Power Supply Cord	2.0 m (6.6 ft)



Straight Guide 1/4", Straight Bit, Wrenches 2

M3600B 12mm (1/2") Router

High performance and durability at less expense

203



Continuous Rating Input	1,650W
Collet Capacity	12 mm or 1/2"
Plunge Capacity	0 - 60 mm (0 - 2-3/8")
No Load Speed (RPM)	22,000
Sound Power Level	97 dB(A)
Dimensions (L x W x H)	284x148x300 mm (11-1/8"x5-7/8"x11-3/4")
Net Weight	5.5 kg (12.2 lbs.)
Power Supply Cord	2.0 m (6.6 ft.)



Straight Guide, Guide Holder Assembly, Collet Sleeve (6mm or 1/4"), Collet Sleeve (8mm or 3/8"), Straight Bit, Wrench

M1902B 82mm (3-1/4") Power Planer

82mm power planer with excellent cost performance

411



Continuous Rating Input	500W
Planing Width	82 mm (3-1/4")
Planing Depth	1 mm (1/32")
Max Shiplapping	9 mm (11/32")
No Load Speed (RPM)	16,000
Sound Power Level	95 dB(A)
Dimensions (L x W x H)	285x157x160mm (11-1/4"x6-3/16"x6-5/16")
Net Weight	2.7 kg (5.8 lbs)
Power Supply Cord	2.0 m (6.6 ft)

Shiplapping: 9mm (11/32")



Planer blade 82, Sharpening Holder Assembly (for unit with resharpenable blade only), Blade gauge assembly, Socket wrench 9, Guide Rule, Dressing stone

M9204B 125mm (5") Random Orbit Sander

Ergonomically designed palm grip for comfortable handling

419



Continuous Rating Input	240W
Pad Size	123 mm (4-7/8")
Abrasive Paper Size	125 mm (5")
Orbits Per Minute (OPM)	12,000
Strokes Per Minute (SPM)	24,000
Orbit Diameter	2.8 mm (1/8")
Sound Pressure Level	81 dB(A)
Sound Power Level	92 dB(A)
Dimensions (L x W x H)	153x123x144 mm (6"x4-7/8"x5-5/8")
Net Weight	1.2 kg (2.6 lbs)
Power Supply Cord	2.0 m (6.6 ft)



Abrasive paper, Dust bag

M9400B 100mm (4") Belt Sander

High performance and durability at less expense

153



Continuous Rating Input	940W
Belt Size	100 x 610 mm (4" x 24")
Belt Speed	380 m/min (1,250 ft/min)
Sound Pressure Level	87 dB(A)
Sound Power Level	98 dB(A)
Dimensions (L x W x H)	354x175x169 mm (14"x6-7/8"x6-5/8")
Net Weight	6.2 kg (13.7 lbs.)
Power Supply Cord	2.0 m (6.6 ft.)



Abrasive belt, Step, Dust bag assembly, Carbon plate

M9200B Finishing Sander

Extremely versatile sander

419



Continuous Rating Input	180W
Pad Size	112 x 102 mm (4-3/8" x 4")
Abrasive Paper Size	114 x 140 mm (4-1/2" x 5-1/2")
Orbits Per Minute (OPM)	14,000
Sound Pressure Level	79 dB(A)
Dimensions (L x W x H)	110x112x133 mm (4-5/16"x4-3/8"x5-1/4")
Net Weight	0.9 kg (2 lbs)
Power Supply Cord	2.0 m (6.6 ft)



Abrasive paper x6

M9203B Finishing Sander

12,000 OPM for increased efficiency and smooth finish sanding

64



Continuous Rating Input	190W
Pad Size	92 x 185 mm (3-5/8" x 7-1/4")
Abrasive Paper Size	93 x 228 mm (3-5/8" x 9")
Orbits Per Minute (OPM)	12,000
Strokes Per Minute (SPM)	24,000
Orbit Diameter	2.0 mm (1/16")
Sound Pressure Level	75 dB(A)
Dimensions (L x W x H)	252x92x154 mm (9-7/8"x3-5/8"x6-1/16")
Net Weight	1.4 kg (3.2 lbs)
Power Supply Cord	2.0 m (6.6 ft)



Abrasive paper #120, Punch Plate, Dust bag

M4000B Blower

In-line grip for higher maneuverability

85



Continuous Rating Input	530W
Air Volume	1.2-2.9 m ³ /min
No Load Speed (RPM)	8,500 - 16,000
Sound Power Level	101 dB(A)
Dimensions (L x W x H)	427x161x212 mm (16-3/4"x6-3/8"x8-3/8")
Net Weight	1.5 kg (3.4 lbs)
Power Supply Cord	2.0 m (6.6 ft)



Nozzle assembly, Sash nozzle

M4001B Blower

600 W Variable Speed Blower

303



Continuous Rating Input	600W
Max Air Volume	0 - 4.1 m ³ /min
Max Air Velocity	0 - 91 m/s
Air Pressure	0 - 5.7 kPa
No Load Speed (RPM)	0 - 16,000
Sound Power Level	93 dB(A)
Dimensions (L x W x H)	480x185x178 mm (18-7/8"x7-1/4"x7")
Net Weight	1.9 - 2.0 kg (4.3 - 4.5 lbs)
Power Supply Cord	2.0 m (6.6 ft.)



Nozzle, Dust Bag

Makita Cordless Part Number Breakdown

DSE	Charger (DC10WA), 2X7.2V - 1.0Ah Batteries (BL7010)	
DW	Charger (DC10WA), 1X10.8V - 1.3Ah Battery (BL1013)	
DWE	Charger (DC10WA), 2X10.8V - 1.3Ah Batteries (BL1013)	
DWYE	Standard Charger (DC10WD), 2X12Vmax - 1.5Ah Batteries (BL1016)	
DSYE	Fast Charger (DC10SB), 2X12Vmax - 1.5Ah Batteries (BL1016)	
DSAE	Fast Charger (DC10SB), 2X12Vmax - 2.0Ah Batteries (BL1021B)	
DSAJ	Fast Charger (DC10SB), 2X12Vmax - 2.0Ah Batteries (BL1021B), Makpac	
DSME	Fast Charger (DC10SB), 2X12Vmax - 4.0Ah Batteries (BL1041B)	
SYE	Standard Charger (DC18SD), 2X18V - 1.5Ah Batteries (BL1815B)	
RYE	Rapid Charger (DC18RC), 2X18V - 1.5Ah Batteries (BL1815B)	
SF	Standard Charger (DC18SD), 1X18V - 3.0Ah Battery (BL1830B)	
RF	Rapid Charger (DC18RC), 1X18V - 3.0Ah Battery (BL1830B)	
RFE/RF2	Rapid Charger (DC18RC), 2X18V - 3.0Ah Batteries (BL1830B)	
RFJ	Rapid Charger (DC18RC), 2X18V - 3.0Ah Batteries (BL1830B), Makpac	
RME	Rapid Charger (DC18RC), 2X18V - 4.0Ah Batteries (BL1840B)	
RTE/RT2	Rapid Charger (DC18RC), 2X18V - 5.0Ah Batteries (BL1850B)	
RTJ	Rapid Charger (DC18RC), 2X18V - 5.0Ah Batteries (BL1850B), Makpac	
PT2	Dual Port Rapid Charger (DC18RD), 2X18V - 5.0Ah Batteries (BL1850B)	
PG2J	Dual Port Rapid Charger (DC18RD), 2X18V - 6.0Ah Batteries (BL1860B), Makpac	
G2	2X18V - 6.0Ah Batteries (BL1860B)	

Makita Coding System - Ending Alphabet

DDF484 R T E

Charger

S - Standard Charger
R - Rapid (Fast) Charger
P - Two Port Charger

Come with Battery

H - 1.3Ah **M** - 4.0Ah
Y - 1.5Ah **T** - 5.0Ah
A - 2.0Ah **G** - 6.0Ah
D - 2.5Ah **L** - 8.0Ah
F - 3.0Ah

Comes with 2 batteries

Other:
B - Double Insulation
C - Electronic Control
F - LED Light
K - Carrying Case
Z - 18V x 2 Tools

Z

Tool come with carton box only

For more information, please contact Makita authorised distributor's technical team.

Combination / Rotary Hammer Drill Capability Chart

		Material for drilling																	Highly reinforced concrete	Concrete, granite, stone, brick	Metal/ wood	Working direction	Drilling/ chiselling ratio		
		EPTA Weight (kg)	0	10	20	30	40	50	60	70	80	90	100	110	120	130	140	150						160	
16mm series	HR166D	1.8~2.4	3.2-16 3.2-10																	Diamond core 32 (dry type)	✓	✓✓✓	✓	↔	■
	SDS-plus		3.2-16 3.2-10																	Diamond core 32 (dry type)	✓	✓✓✓	✓	↔	■
17mm series	DHR171	2.1~2.8	3.2-17 3.2-10																	Diamond core 32 (dry type)	✓	✓✓✓	✓	↔	■
	SDS-plus		3.2-17 3.2-10																	Diamond core 32 (dry type)	✓	✓✓✓	✓	↔	■
18mm series	HR1840/41F	2.0~2.5	3.2-18 3.2-10																	Diamond core 32 ~ 65 (dry type)	✓	✓✓✓	✓	↔	■
	SDS-plus		3.2-18 3.2-10																	Diamond core 32 (dry type)	✓	✓✓✓	✓	↔	■
18mm series	DHR182	2.4~3.2	3.2-18 3.2-10																	Diamond core 32 (dry type)	✓	✓✓✓	✓	↔	■
	SDS-plus		3.2-18 3.2-10																	Diamond core 32 (dry type)	✓	✓✓✓	✓	↔	■
20mm series	DHR202	3.5	3.2-20 4-12																	Diamond core 32 (dry type)	✓	✓✓✓	✓	↔	■
	SDS-plus		3.2-20 4-12 35-54																	Diamond core 32 ~ 65 (dry type)	✓	✓✓✓	✓	↔	■
22mm series	DHR2230	2.6	3.2-22 4-14																	Diamond core 32 ~ 65 (dry type)	✓	✓✓✓	✓	↔	■
	SDS-plus		3.2-22 4-14 35-54																	Diamond core 32 ~ 65 (dry type)	✓	✓✓✓	✓	↔	■
22mm series	MT870	2.5	3.2-22 4-14																	Diamond core 32 ~ 65 (dry type)	✓	✓✓✓	✓	↔	■
	SDS-plus		3.2-22 4-14 35-54																	Diamond core 32 ~ 65 (dry type)	✓	✓✓✓	✓	↔	■
23mm series	HR2300	2.7	3.2-23 4-15																	Diamond core 32 ~ 70 (dry type)	✓	✓✓✓	✓	↔	■
	SDS-plus		3.2-23 4-15 35-68																	Diamond core 32 ~ 70 (dry type)	✓	✓✓✓	✓	↔	■
23mm series	HR2310T	2.9	3.2-23 4-15																	Diamond core 32 ~ 70 (dry type)	✓	✓✓✓	✓	↔	■
	SDS-plus		3.2-23 4-15 35-68																	Diamond core 32 ~ 70 (dry type)	✓	✓✓✓	✓	↔	■
23mm series	HR2320T	2.9	3.2-23 4-15																	Diamond core 32 ~ 70 (dry type)	✓	✓✓✓	✓	↔	■
	SDS-plus		3.2-23 4-15 35-68																	Diamond core 32 ~ 70 (dry type)	✓	✓✓✓	✓	↔	■
24mm series	HR2460	2.8	3.2-24 4-16																	Diamond core 32 ~ 65 (dry type)	✓	✓✓✓	✓	↔	■
	SDS-plus		3.2-24 4-16 35-54																	Diamond core 32 ~ 65 (dry type)	✓	✓✓✓	✓	↔	■
24mm series	HR2470	2.9	3.2-24 4-16																	Diamond core 32 ~ 65 (dry type)	✓	✓✓✓	✓	↔	■
	SDS-plus		3.2-24 4-16 35-54																	Diamond core 32 ~ 65 (dry type)	✓	✓✓✓	✓	↔	■
24mm series	DHR241	3.5	3.2-20 4-12																	Diamond core 32 (dry type)	✓	✓✓✓	✓	↔	■
	SDS-plus		3.2-20 4-12 35-54																	Diamond core 32 (dry type)	✓	✓✓✓	✓	↔	■
24mm series	DHR242	3.1~3.8	3.2-24 4-16																	Diamond core 32 ~ 65 (dry type)	✓	✓✓✓	✓	↔	■
	SDS-plus		3.2-24 4-16 35-54																	Diamond core 32 ~ 65 (dry type)	✓	✓✓✓	✓	↔	■
26mm series	DHR263	3.5	3.2-26 4-18																	Diamond core 32 ~ 65 (dry type)	✓	✓✓✓	✓	↔	■
	SDS-plus		3.2-26 4-18 35-54																	Diamond core 32 ~ 65 (dry type)	✓	✓✓✓	✓	↔	■
26mm series	HR2600 Series	2.8~2.9	3.2-26 4-18																	Diamond core 32 ~ 80 (dry type)	✓	✓✓✓	✓	↔	■
	SDS-plus		3.2-26 4-18 35-68																	Diamond core 32 ~ 80 (dry type)	✓	✓✓✓	✓	↔	■
26mm series	HR2630 Series	2.8~3.1	3.2-26 4-18																	Diamond core 32 ~ 80 (dry type)	✓	✓✓✓	✓	↔	■
	SDS-plus		3.2-26 4-18 35-68																	Diamond core 32 ~ 80 (dry type)	✓	✓✓✓	✓	↔	■
26mm series	HR2650 Series	3.0~3.2	3.2-26 4-18																	Diamond core 32 ~ 80 (dry type)	✓	✓✓✓	✓	↔	■
	SDS-plus		3.2-26 4-18 35-68																	Diamond core 32 ~ 80 (dry type)	✓	✓✓✓	✓	↔	■
26mm series	HR2661	3.2	3.2-26 4-18																	Diamond core 32 ~ 80 (dry type)	✓	✓✓✓	✓	↔	■
	SDS-plus		3.2-26 4-18 35-68																	Diamond core 32 ~ 80 (dry type)	✓	✓✓✓	✓	↔	■
26mm series	M8701	2.7	3.2-26 4-18																	Diamond core 32 ~ 80 (dry type)	✓	✓✓✓	✓	↔	■
	SDS-plus		3.2-26 4-18 35-68																	Diamond core 32 ~ 80 (dry type)	✓	✓✓✓	✓	↔	■
28mm series	HR2800 Series	3.4~3.6	3.2-28 6-20																	Diamond core 32 ~ 80 (dry type)	✓	✓✓✓	✓	↔	■
	SDS-plus		3.2-28 6-20 35-80																	Diamond core 32 ~ 80 (dry type)	✓	✓✓✓	✓	↔	■
28mm series	DHR282 Series	3.9~5.0	3.2-28 6-20																	Diamond core 32 ~ 65 (dry type)	✓	✓✓✓	✓	↔	■
	SDS-plus		3.2-28 6-20 35-54																	Diamond core 32 ~ 65 (dry type)	✓	✓✓✓	✓	↔	■
28mm series	HR001G Series	3.9~4.6	3.2-28 6-20																	Diamond core 32 ~ 65 (dry type)	✓	✓✓✓	✓	↔	■
	SDS-plus		3.2-28 6-20 35-54																	Diamond core 32 ~ 65 (dry type)	✓	✓✓✓	✓	↔	■
30mm series	HR3210FCT Series	4.8~5.4	4-32 10-22																	Diamond core 32 ~ 90 (dry type)	✓✓✓	✓✓✓	✓	↔	■
40mm series	HR4002	6.6	10-40 16-32																	✓✓✓	✓✓✓		↔	■	
	SDS-max		10-40 16-32 20-105																	✓✓✓	✓✓✓		↔	■	
40mm series	HR4013C Series	6.2~6.8	10-40 16-35																	✓✓✓	✓✓✓		↔	■	
	SDS-max		10-40 16-35 20-105																	✓✓✓	✓✓✓		↔	■	
40mm series	DHR400	7.3~8.1	10-40 16-35																	✓✓✓	✓✓✓		↔	■	
	SDS-max		10-40 16-35 20-105																	✓✓✓	✓✓✓		↔	■	
40mm series	HR005G	7.4~7.9	10-40 16-35																	✓✓✓	✓✓✓		↔	■	
	SDS-max		10-40 16-35 20-105																	✓✓✓	✓✓✓		↔	■	
45mm series	HR4511C Series	8.2~9.0	10-45 22-40																	✓✓✓	✓✓✓		↔	■	
	SDS-max		10-45 22-40 20-125																	✓✓✓	✓✓✓		↔	■	
50mm series	HR5212C Series	10.9~11.9	19-52 25-45																	✓✓✓	✓✓✓		↔	■	
	SDS-max		19-52 25-45 20-160																	✓✓✓	✓✓✓		↔	■	
50mm series	HR006G Series	12.9~14.3	19-52 25-45																	✓✓✓	✓✓✓		↔	■	
	SDS-max		19-52 25-45 20-160																	✓✓✓	✓✓✓		↔	■	

approx: 50% drilling, 50% chiselling

- Tungsten Carbide-tipped usable range
- Recommended range
- Core bits

- ✓✓✓ Optimal
- ✓ Possible

Carbon Brush List

Carbon Brush	Part Number	Model								
CB-1	181019-9	903								
CB-51	181021-2	1902	3700B	4300BV	6013BR	6016	6300NB			
CB-55	181026-2									
CB-55A	B-80248	8416	JR3000V							
CB-64	191627-8	6412	6413	6510LVR	9035	906	BO3710	BO4540	DP4700	GD0603
CB-64A	B-80254	GV6010	JV0600K							
CB-65	191628-6									
CB-65A	A-81309	6905B	906H	JS1600	JS1670					
CB-70	191914-5	6501								
CB-70A	A-81212									
CB-85	191998-3									
CB-85A	B-80282	HP1630								
CB-100	181030-1	1100	6906	9045B	9215SB	9218SB	9924DB	JN3200	JS3200	PC1100
CB-100A	B-80298									
CB-106	181410-1									
CB-106A	A-81290	1911B	3620	RP0900	UT1301					
CB-132	191972-1	UC3520A	UC4020A	UC3541A	UC4041A					
CB-153	181044-0	1804N	1805N	2012NB	2416S	3501N	3600H	3601B	3612BR	4107R
CB-153A	B-80329	5008B	5008MG	5016B	5103N	5201N	5401N	5402	6910	9105
		9401	HS0600	LF1000	LS1013	LS1016	LS1019L	LS1040	LS1212	LS1214
		LS1216	LS1219L	LS1440	N5900B	TW1000	UC3530A	UC3531A	UC4030A	UC4051A
CB-173	195483-8	VC2510L	VC3210L							
CB-203	191953-5	2414NB	3612C	HW1200	HW1300	LC1230	LW1400	LW1400	RP1801	
CB-203A	B-80341									
CB-253	194547-5	PC5000C								
CB-303	191963-2	2107F	4100NH	4100NH3Z	4131	5606B	5740NB	5806B	9015B	9016B
CB-303A	B-80379	9227C	9237C	CA5000	DA4000LR	GA5010	GA5020	GA6010	HS7010	HS7600
		JN3201J	JR3050T	JR3060T	JR3070CT	JS3201J	LS0714	PV7000C	UB1100	UB1101
		UB1102	UB1103	UT1305	UT2204					
CB-325	194074-2	9553NB	9556NBG	9556PBG	9556HBG	9556HP	9557NBG	9563H	GA4040	GD0600
		GD0601	GD0602	HR2230	HR2300	HR2310T	HR2320T	HR2460	HR2470	HR2600
		HR2601	HR2610	HR2611FT	HR2630	HR2631FT	HR2800	HR2810		
CB-411	191940-4	3709	3901	4403	6922NB	9031	9500NB	9523NB	DS4011	JN1601
CB-411A	B-80391	KP0800	RT0700C	TD0101F	TW0200	TW0350				
CB-415	191950-1	6904VH								
CB-415A	B-80400									
CB-419	191962-4	4304	4350CT	9035H	BO4510H	BO4556	BO5031	DA3010F	FS2300	FS2500
CB-419A	B-80422	FS2700	FS4300	HP1620	HP2030	HP2050	HP2070	HR1830	HR2020	HR2440
		JS1300	TD0100	UH4570X	UH5570X	UH6570X	UH7580X			
CB-459	194722-3	GA4030	GA4031	GA4034	GA54530	GA4534	GA5030	GA5034	HR1840	HR1841
		JS1000	JS1601	JS1602	PJ7000	TM3000C	TM3010C			
	3641000	HW111								
	3641160	HW102								
	375009-001	SJ401								
	EIB106C	HB500								
	JM23000123	LH1201FL	LS1018L	MLT100						

Auto Cut - Out Carbon Brush

CB-105	181038-5	HM0810A	HM0810TA	HR2010	HR3520					
CB-105A	B-80307									
CB-155	181048-2	HM1201								
CB-155A	B-80335									
CB-204	191957-7	4112HS	4114S	9617	GA7010C	GA7012C	GA7020	GA7030	GA7040R	GA7040S
CB204A	B-80357	GA9010C	GA9012C	GA9030	GA9030R	GA9040S	GA9050	GS5000	HM1302	HM1305
		HM1306	HM1810	SA7000C						
CB-218	197129-2	GA7060	GA7060R	GA7061R	GA7062	GA7063R	GA9060	HM1812		
CB-318	191978-9	9563C	GA4040C	GA4041C	GD0800C	PK5001C	PO6000C	PW5001C	SG1250	SG1251J
CB-327	194285-9	HR3000C								
CB-350	194160-9	HK1820	HM0870C	HM0871C	HR3200C	HR4001C	HR4002	HR4003C	HR4003C	HR4030C

Carbon Brush for Cordless Tools

CB-430	191971-3	8414D	DCS550	DCO180	BGA450	DGA402	DGA452	DGD800	BHR240	DJN161
CB-438		DJS101	DJS161	DJV180	DPB180	DPJ180	DSS501	BUB360	DUC122	DHR165
		DUB361								
CB-434	193466-2	6932FD	6935FD	BTW121						
CB-440	194427-5	DDA351	DDF442	DDF444	BDF450	BDF452	DDF456	DDF458	DDF482	DFR550
		DFS450	DFS451	BHP442	DHP444	DHP444	BHP450	BHP452	BHP454	DHP456
		DHP458	DHP482	DJS130	BTD142	DTD146	DTP140	DTW152	DTW251	DBN500
		TD091D								
CB-441	194435-6	DHR202	DHR241	DHS630	DJR181	DJR182	DJR186	DKP180	DLS713	DSS610
		DTW450								
CB-442	194928-3	BHR261	BHR262	BUC250	BUH550	BUH650	DHR263	DHS710	DUC252	DUC302
		DUH651								
CB-448	196854-2	DTW152	DTW251							

How to Maximise Battery Performance

Rechargeable Tool Battery Don'ts

- **Do not Use the Battery till it is flat :** Using the battery till it is flat, can permanently damage the poles and shorten battery life. Recharge the battery as soon as your tool starts to slow down. Unless you are using a NiCd battery operated tool.
- **Do not Overload the Battery :** Use the cordless tool within specification. Do not overload the cordless tool.
- **Do not Get Battery Wet:** Avoid exposing your batteries to water. Immediately wipe away any moisture on the tool or battery.
- **Do not throw or drop the Battery:** Dropping or throwing the battery may cause damage to battery.

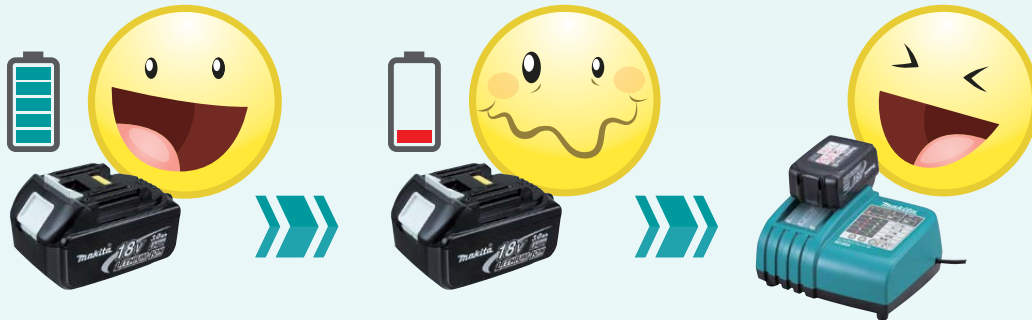

You should stop your operations and charge it when you feel the power is getting lower and lower. This will help to reduce the load to battery and to extend battery lifetime. Never use till empty!!!





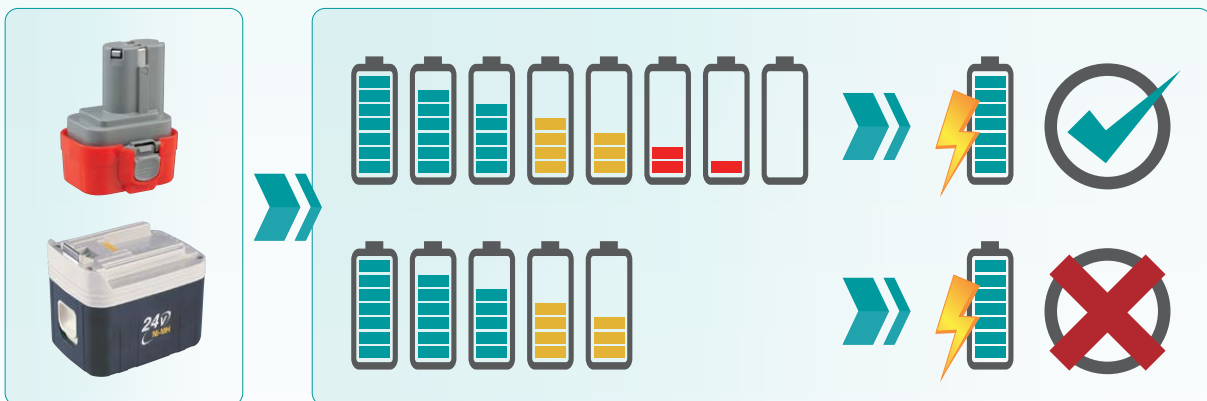



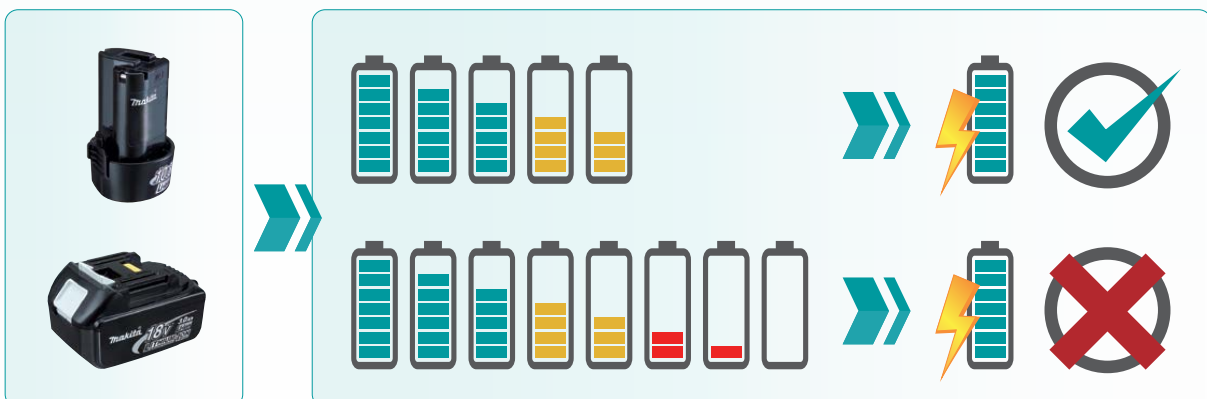









































When to CHARGE a Ni-Cd / Ni-MH Battery



When to CHARGE a Li-ion Battery



Icon

 Double Insulation	 Torque Setting 16	 Bayonet Shank Jig Saw Blade	 Static Free Hose
 Variable Speed	 Torque Setting 18	 Laser Marker	 SDS-PLUS Shank
 Brake	 Torque Setting 20	 Orbital Cutting	 SDS-MAX Shank
 Reversing	 Torque Setting 21	 Hook & Loop	 17mm Hex Shank
 Mechanical 2-Speed	 Torque Setting 21_41	 Depth Adjustment	 21mm Hex Shank
 Mechanical 3-Speed	 Dust Collection	 Sequential and Bump-fire	 28.6mm Hex Shank
 Electronic 2-Speed	 Torque Limiter	 Auto Firing Stop	 30mm Hex Shank
 Electronic 3-Speed	 Constant Speed	 Automatic Oiling	 Built-in Job Light
 Electronic 4-Speed	 Soft Start	 Stainless Tank	 Anti-restart function
 Keyless Chuck	 Bevel Cutting 45 left	 Grass Tangle Removing Function	 Toolless blade change
 Clutch-equipped	 Bevel Cutting L45 R5	 Chain Brake	
 Torque Setting 6	 Bevel Cutting 45 LR	 Anti Vibration	
 Torque Setting 9	 Makita Shank Jig Saw Blade	 Revolving Hose	



www.makita.com.sg

TRADEMARKS



Makita Corporation and its affiliates (collectively referred to as "Makita") are the registered owners of the above trademarks and own the exclusive rights to these trademarks. A party who manufactures, advertises, offers for sale, sells, distributes, imports or exports power tools, batteries and/or related accessories using a trademark which is identical or similar to our trademarks may have infringed our trademarks. Makita take a serious view of trademark infringement and will not hesitate to take any legal action against any party who infringes our trademark rights.

Makita Singapore Pte Ltd

7, Changi South Street 3, Singapore 486348
 Phone : +65-6546-8700 Fax : +65-6546-8711
 Email : msgproductteam@makita.com.sg
 Website : www.makita.com.sg
 Facebook : www.facebook.com/MakitaSG



Visit our website



PRINTED IN SINGAPORE